

726 Series

LED Architectural Wall or Pole Mount

Type:

Catalog Number:

Project/Location:

Approved By:

SPECIFICATIONS

Housing: Heavy-duty construction of corrosion resistant die cast aluminum. Stainless steel hardware.

Gasket: Closed cell silicone foam gasket. Seals out moisture, dust, and insects for weather-tight operation.

Mounting: Surface wall over standard J-box or pole mount slips over 2-3/8" OD tenon.

Diffuser: Sealed optic chamber in detachable reflector secured with a set-screw.

Driver: Constant current and Universal input voltage 120-277V, 50-60Hz line voltage frequency. Operating temperature -20°C to 40°C, Power Factor $\geq .90$.

LED: Specify amber (A), blue (B), green (G), red (R), or 3000 (30K), 3500 (35K), 4000 (40K), and 5000 (50K) – 40K standard.

Lumens: 1530.

Finish/Colors: Zinc based primer with polyester powder coat finish in Matte Black (MB), Matte White (MW), Matte Bronze (BZ), Silver Gray (SG), or a custom color (CC).

Testing: LM79, LM80, ETL.

Conforms to UL Standard 1598. Suitable for wet locations.

See options page for additional information or consult factory.



Series	Source	Wattage/Max
726	LED	30W

ORDERING EXAMPLE

726 – PT – 30WLED – 40K – 120 – MB

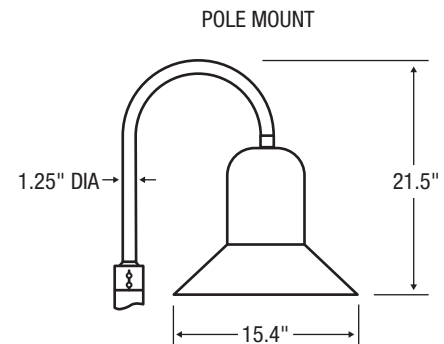
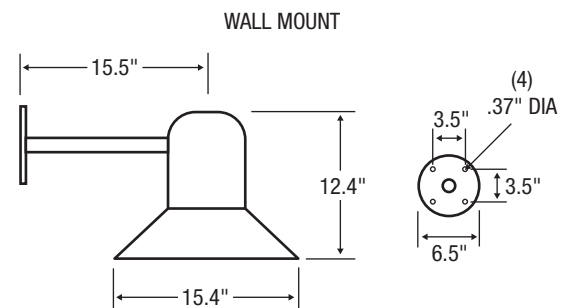

MOUNTING OPTIONS

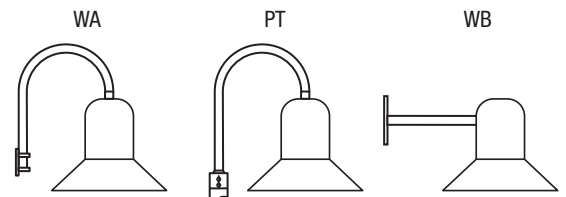

- WA Wall arm hooked
- PT1 One arm post top
- PT2 Two arms post top at 90° or 180°
- PT3 Three arms post top at 120°
- WB Wall bracket

ELCAST LIGHTING

815 S. Kay Ave., Addison, IL 60101 USA • 630.543.5390
www.ElcastLtg.com • ElcastLtg@ElcastLtg.com

Made in USA – 5 year limited warranty

©2017. Specifications are subject to change without notice. Consult factory for verification.