



FY led linear high bay provides high output illumination for various commercial and industrial applications, like factory, warehouse, exhibition hall, gymnasiums, retail boxstores.

Product Feature :

High lumen output, 135LPW.

AC100-277V and AC200-480V available.

5 years warranty.

Compatible with dimmers, Sensors and other control strategies, to achieve deeper energy-saving.

Technical parameters

Model	FY-HB-600D-105W	FY-HB-600D-160W	FY-HB-1200D-160W	FY-HB-1200D-225W	FY-HB-1200D-320W
Power	105W	160W	160W	225W	320W
Length	2FT	2FT	4FT	4FT	4FT
Size	620*355*75	620*355*75	1203*355*75	1203*355*75	1203*355*75
Lumen	130-140lm/w				
PC cover	Clear, Frosted				
Driver	UL driver, dimmable available				
Input Voltage	AC100-277V , AC200-480V 50Hz/60Hz				
CCT	3000K-6500K				
CRI	80 Ra				
Warranty	5 Years				

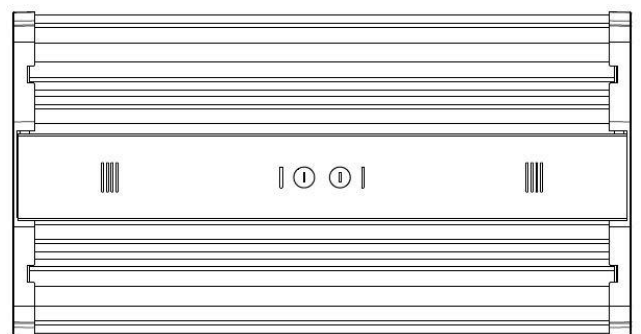
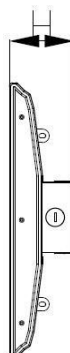
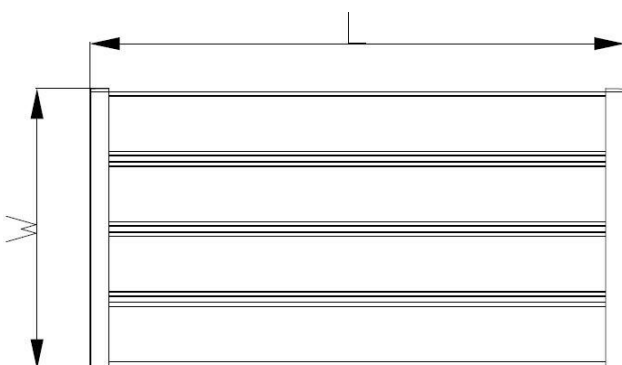

DLC Information

Model No.	Light Output(Lumen)	Wattage(W)	Efficacy(lm/w)	Dimming Status (Yes or No)	CCT(K)
FY-HB-1200D-105WDF (L50K576C302P)	16170 lm	105 W	154 lm/W	Yes	5000 K
FY-HB-1200D-105WNF (L50K576C302P)	16170 lm	105 W	154 lm/W	No	5000 K
FY-HB-1200D-105WDF (U50K576C303P)	16170 lm	105 W	154 lm/W	Yes	5000 K
FY-HB-1200D-105WNF (U50K576C303P)	16170 lm	105 W	154 lm/W	No	5000 K
FY-HB-1200D-160WDF (L50K864C302P)	24640 lm	160 W	154 lm/W	Yes	5000 K
FY-HB-1200D-160WNF (L50K864C302P)	24640 lm	160 W	154 lm/W	No	5000 K
FY-HB-1200D-160WDF (U50K792C303P)	21120 lm	160 W	132 lm/W	Yes	5000 K
FY-HB-1200D-160WNF (U50K792C303P)	21120 lm	160 W	132 lm/W	No	5000 K
FY-HB-1200D-225WDF (L50K1296C302P)	29700 lm	225 W	132 lm/W	Yes	5000 K
FY-HB-1200D-225WNF (L50K1296C302P)	29700 lm	225 W	132 lm/W	No	5000 K
FY-HB-1200D-225WDF (U50K1296C303P)	29700 lm	225 W	132 lm/W	Yes	5000 K
FY-HB-1200D-225WNF (U50K1296C303P)	29700 lm	225 W	132 lm/W	No	5000 K
FY-HB-1200D-320WDF (L50K1728C302P)	42240 lm	320 W	132 lm/W	Yes	5000 K
FY-HB-1200D-320WNF (L50K1728C302P)	42240 lm	320 W	132 lm/W	No	5000 K
FY-HB-1200D-320WDF (U50K1776C303P)	49280 lm	320 W	154 lm/W	Yes	5000 K
FY-HB-1200D-320WNF (U50K1776C303P)	49280 lm	320 W	154 lm/W	No	5000 K

Lumen Maintenance

Ambient Temperature	TM-21 Lumen Maintenance (50,000 hours)	Calculated L70 (hours)
50°	87.2%	>54,000

Product information

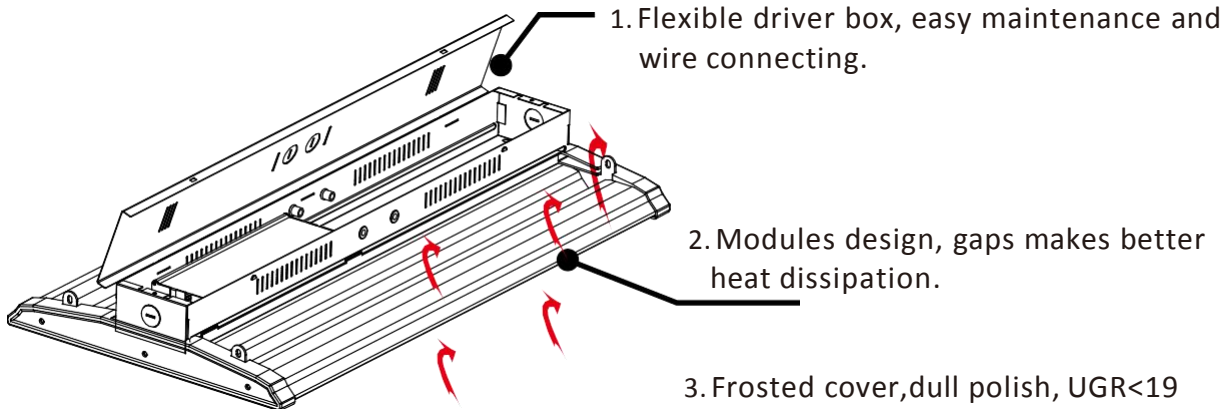

Different installation:

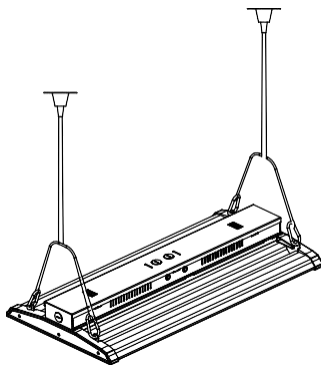

Suspended cable

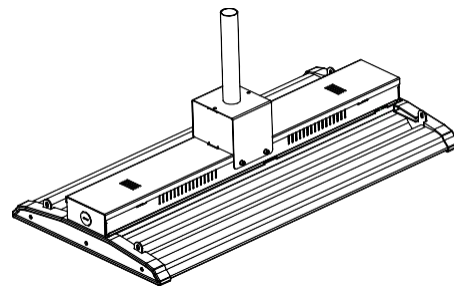

pendant mount

Motion sensor available:

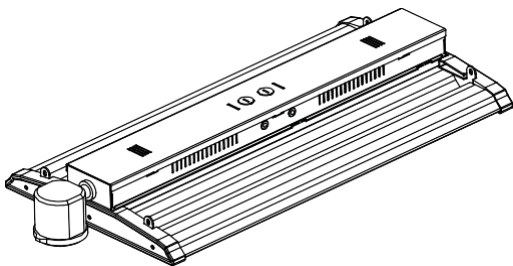

When used in combination with 1-10V dimmable LED drivers and ballasts, the sensors can achieve 3-step dimming function, 100%---> low light--->off. And the sensors build in adjustable daylight sensors, very easy to install and cost-effective.

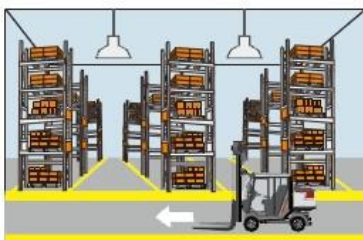

With sufficient ambient light, the sensor does not switch on the lamp.

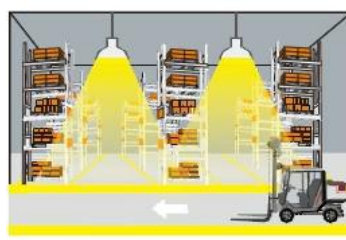

With insufficient ambient light, the sensor switches on the lamp when motion is detected.

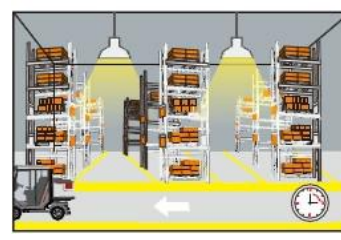

After hold time, the sensor dims the lamp at a low light level if no new motion trigger.

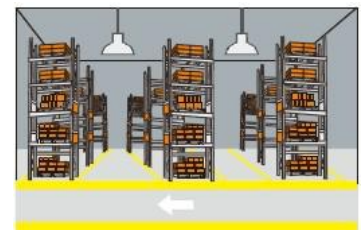

After stand-by period, the sensor switches off the lamp if no motion is detected in its detection zone.

Tel: +86-0755-29304110

Website: www.ledtubeschina.com

E-mail: service@ledtubeschina.com