

CHUTONG ELECTRIC CO LIMITED

Magnifying led lamp

	Item number: CH01F5
	NOT Dimmable Lens: 5" 127mm magnification: 3/5/8diopter Light source: LED 12W Voltage:110V- 220V Color temperature:6400K Mount: clamp Body Color: white

Magnifying lamp application

1 suitable for circuit board inspection, processing, installation at electronics industry. Electronic engineers to observe and test the micro elements, components of dense circuit board

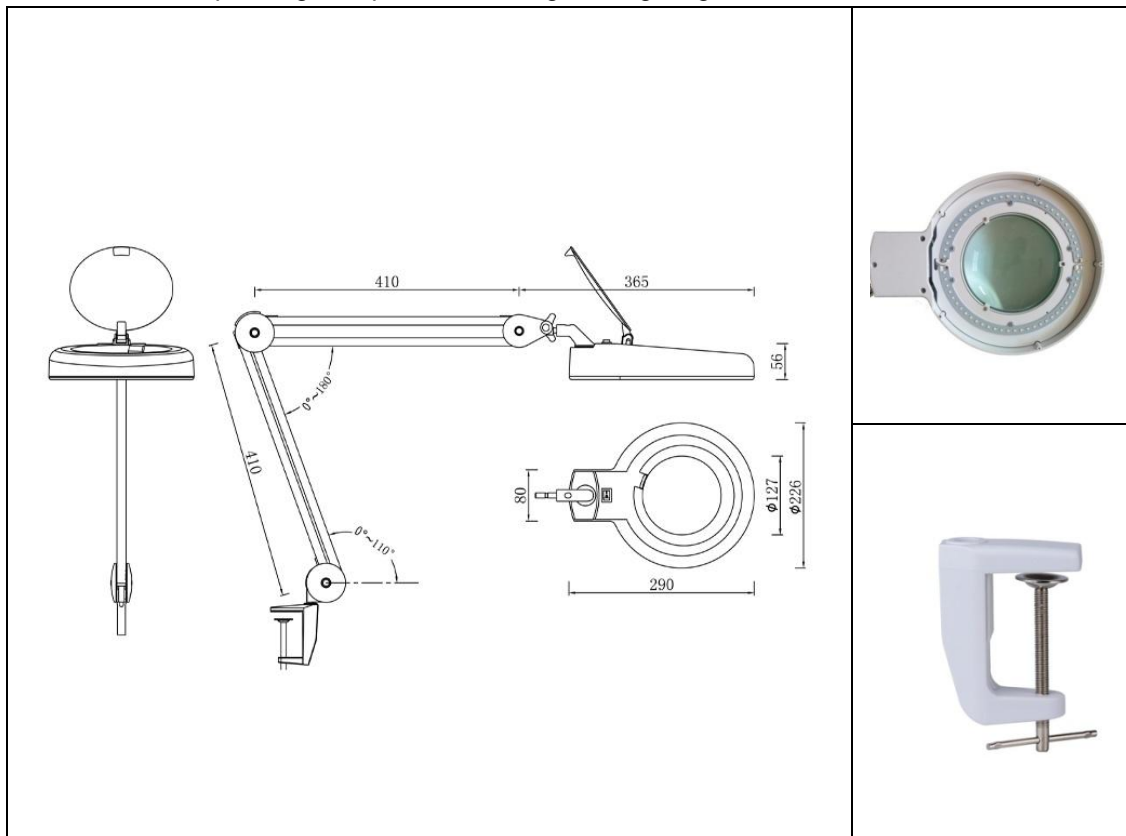

2 suitable for engraving, fine operation and observation.

3 suitable for simple surgical operation. Enlarge the lighting for beautician and medical staff



CHUTONG ELECTRIC CO LIMITED









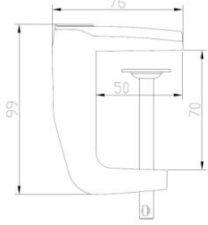

Body color

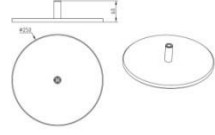
white	black	ESD black
		

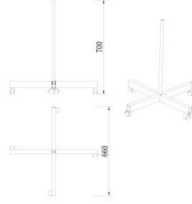
Magnifier lamp Features: 3D5D8D Diopter Magnification

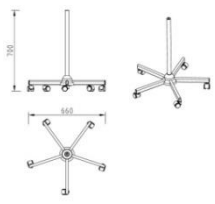
5inch 127mm Clear and illuminating magnifying lens with protective cover

The lens head can rotate left and right with 360 degrees and flip up and down 180 degrees, Soft cool bulb for natural color and shadow-free magnification, Power on and off switch, Articulated arm, no visible springs, Hydraulic look, Conveniently adjustable height and arm for magnification in any position

			
Clamp base		Table base	
			
F4 floor base		F5 floor base	
			
FC floor base		F53 floor base	

CHUTONG ELECTRIC CO LIMITED

Lightness



Item number

Base	Body color	ITEM NUMBER	magification
clamp	White/Black	CH01WC /CH01BC	3D5D/8D
table	White/Black	CH01WT/CH01BC	3D5D/8D
Floor			
F4	White/Black	CH04WF4/CH01BF4	3D5D/8D
F5	White/Black	CH04WF5/CH01BF5	3D5D/8D
FC	White/Black	CH04WFC/CH01BFC	3D5D/8D

Application Scope

The use of magnifying glass working lamp is not limited to illumination, but also has the function of magnifying glass, which makes the observation and analysis of users more meticulous and meticulous. It is widely used in reading and learning, electronic product inspection, stamp collecting, nail painting, embroidery, jewelry and antique appreciation, currency checking, handicraft making, clock maintenance, specimen making, etc. Precision PCB or electronic components inspection, fine material identification, fabric pattern or pattern inspection, reading newspapers for the elderly, etc.

Suitable for: students, electronic maintenance personnel, electronic engineers, beauticians, antique collectors, stamp collectors, DIY enthusiasts, craftsmen, watch repairmen, dentists, material analysts, cloth quality control personnel, elderly people with poor eyesight, etc.

Application places: home, electronic factory, laboratory, dental clinic, jewelry shop, beauty salon, Clock Repair shop, digital electronic products repair shop, cloth factory, etc.