

Job Name:

System Reference:

Date:

MODULAR WATER-SOURCE VRF HEAT PUMP SYSTEM**FEATURES**

- Single modules up to 20 tons with the ability to combine single modules for systems up to 30 tons
- 208/230V, 3-Phase, 60Hz and 460V, 3-Phase, 60Hz options
- Designed for closed water loops
- 0-10V output signal to modulate water flow for compliance with energy codes
- Features Variable Evaporating Temperature (VET) technology, which enables the outdoor unit to raise the target evaporation temperature based on the difference between set point and return air temperature, saving energy.
- Water flow can be stopped while the unit is in a thermo-off state, saving on pump energy consumption. For twinned systems, both modules must be thermo-off to stop water flow.
- Enhanced water-side heat exchanger design for improved efficiency and reduced risk of clogging
- Self-cooling cabinet design
- Inlet water temperature range: 23-113° F
- Max. Total Refrigerant Piping Length: 984' (P72,96,120), 1,640' (P144,168,192,216,240,264,288,312,336,360)
- Connects to CITY MULTI® indoor units; controlled via CITY MULTI® Controls Network (CMCN)
- External finish: Acrylic-painted steel
- Stack multiple units on a field-supplied rack to take advantage of vertical space when available
- Extended 10-year parts and compressor warranty available

ACCESSORIES

- Twinning Kit (required) (CMY-Y100CBK3)
- Joint Kit (for details see Pipe Accessories Submittal)
- Header Kit (for details see Pipe Accessories Submittal)

SPECIFICATIONS: PQHY-P144YSLMU-A1

Specifications			System
Unit Type			PQHY-P144YSLMU-A1
Nominal Cooling Capacity (208/230V)		Btu/h	144,000
Nominal Heating Capacity (208/230V)		Btu/h	160,000
Total Net weight of Modules		Lbs. (kg)	800 (362)
Electrical Power Requirements		Voltage, Phase, Hertz	
		460V, 3-phase, 60Hz	
Piping Diameter (Brazed)			1-1/2 NPT
From Twinning Kit to First Joint or Header		Liquid pipe	In. (mm)
		Gas pipe	In. (mm)
Max. Total Refrigerant Line Length		Ft.	1,640
Max. Refrigerant Line Length (Between ODU & IDU)		Ft.	541
Max. Control Wiring Length		Ft.	1,640
Indoor Unit		Total capacity	
		50~130% of heatsource unit capacity	
Sound pressure level (measured in anechoic room)		Model/Quantity	
		P06~P96/1~31	
		dB(A)	49
Compressor Operating Range			12% - 100%
AHRI Ratings (Ducted/Non-Ducted)		EER	
		15.2 / 19	
		IEER	
		22.5 / 26.1	
		COP	
		5.32 / 6.01	

Refer to Module Data^{*1}

Specifications			Module 1 ^{*1}	Module 2 ^{*1}
Unit Type			PQHY-P72YLMU-A1	PQHY-P72YLMU-A1
Nominal Cooling Capacity (208/230V)		Btu/h	72,000	72,000
Nominal Heating Capacity (208/230V)		Btu/h	80,000	80,000
Operating Temperature Range	Cooling (Indoor)	W.B.	59~75°F (15~24°C)	59~75°F (15~24°C)
	Heating (Indoor)	D.B.	59~81° F (15~27°C)	59~81° F (15~27°C)
Operating Water Temperature Range	Cooling	°F	50~113° F (4~45° C)	50~113° F (4~45° C)
	Heating	°F	50~113° F (4~45° C)	50~113° F (4~45° C)
External dimension H x W x D		In.	43-5/16 x 34-11/16 x 21-11/16	43-5/16 x 34-11/16 x 21-11/16
		mm	1,100 x 880 x 550	1,100 x 880 x 550
Net weight		lbs. (kg)	400 (181)	400 (181)
External finish			Galvanized steel sheets	Galvanized steel sheets
Electrical Power Requirements		Voltage, Phase, Hertz		
		460V, 3-phase, 60Hz		
Minimum Circuit Ampacity		A	6	6
Maximum Overcurrent Protection		A	15	15
Circulating Water (quality must meet regulations)				
Flow Rate		G/min (gpm)	25.4	25.4

SPECIFICATIONS: PQHY-P144YSLMU-A1

Specifications		Module 1 ^{*1}		Module 2 ^{*1}	
Unit Type		PQHY-P72YLMU-A1		PQHY-P72YLMU-A1	
	L/s		1.6		1.6
Pressure Drop	Ft.		8.0		8.0
	psi		3.48		3.48
Operation Volume Range	G/min (gpm)		13.2 ~ 31.7		13.2 ~ 31.7
	L/m		50 ~ 120		50 ~ 120
Maximum Water Pressure	MPa		2		2
	psi		290		290
Water-source Connection for Inlet and Outlet		In.	1-1/2 NPT		1-1/2 NPT
Piping Diameter (Braze)					
From Modules to Twinning Kit	Liquid (High Pressure)	In. (mm)	3/8 (9.52)		3/8 (9.52)
	Gas (Low Pressure)	In. (mm)	3/4 (19.05)		3/4 (19.05)
Sound pressure level (measured in anechoic room)		dB(A)	46		46
Compressor Type x Quantity			Inverter scroll hermetic compressor x 1		Inverter scroll hermetic compressor x 1
Motor output	kW		4.3		4.3
Lubricant			MEL32		MEL32
Refrigerant			R410A x 11 lbs. + 1 oz. (5.0 kg)		R410A x 11 lbs. + 1 oz. (5.0 kg)
Protection Devices	High pressure protection		High pressure sensor, High pressure switch at 4.15 MPa (601 psi)		High pressure sensor, High pressure switch at 4.15 MPa (601 psi)
	Inverter circuit		Over-heat protection, Over-current protection		Over-heat protection, Over-current protection
	Compressor		Over-heat protection		Over-heat protection

*1 Each individual module requires a separate electrical connection. Reference electrical data for each individual module.

Notes:

DIMENSIONS: PQHY-P144YSLMU-A1

Unit : mm(in)

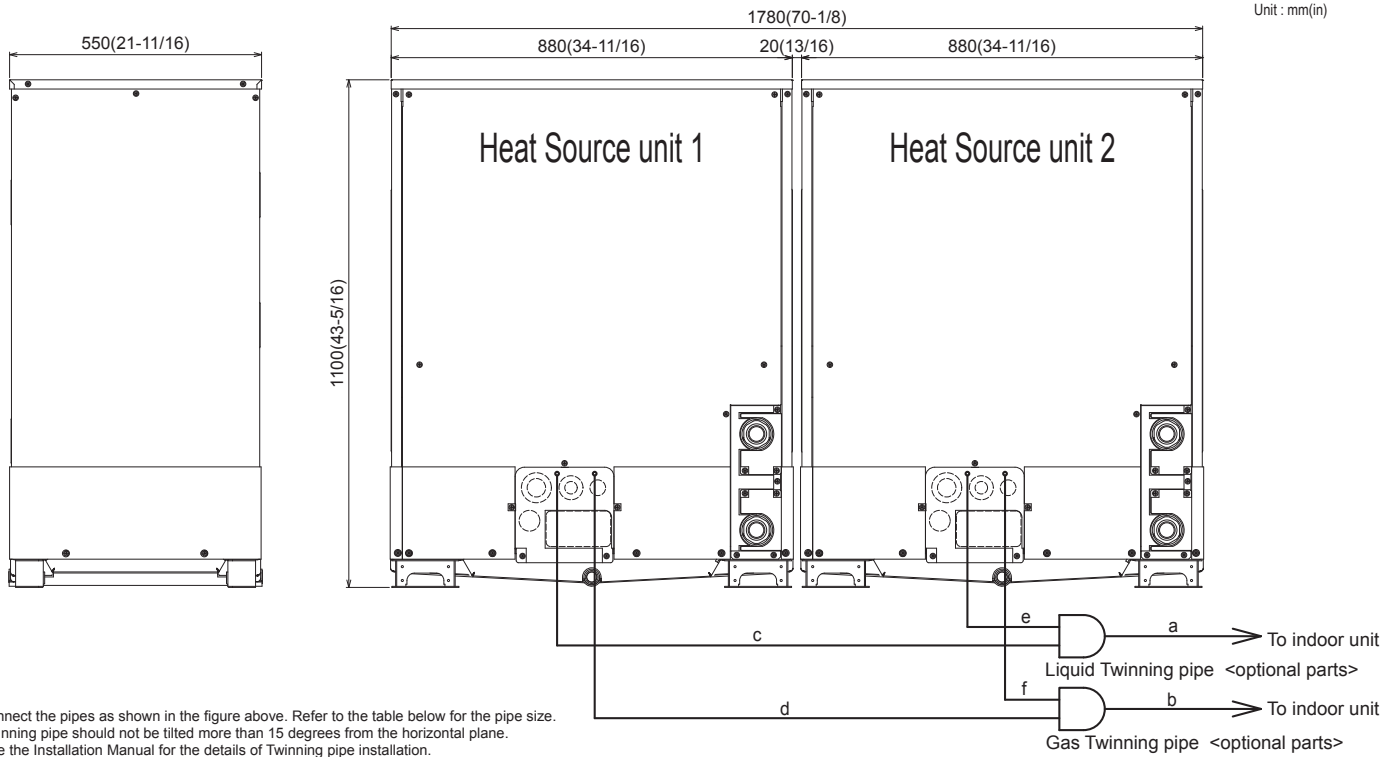

- Note 1. Connect the pipes as shown in the figure above. Refer to the table below for the pipe size.
 2. Twinning pipe should not be tilted more than 15 degrees from the horizontal plane.
 3. See the Installation Manual for the details of Twinning pipe installation.
 4. The pipe section before the Twinning pipe (sections "a" and "b" in the figure) must have at least 500mm(19-11/16) of straight section (*including the straight pipe that is supplied with the Twinning pipe).
 5. Only use the Twinning pipe by Mitsubishi (optional parts).

Twinning pipe connection size

Package unit name		PQHY-P144YSLMU-A1	PQHY-P168YSLMU-A1	PQHY-P192YSLMU-A1	PQHY-P216YSLMU-A1	PQHY-P240YSLMU-A1
Component unit name	Heat Source unit 1	PQHY-P72YLMU-A1	PQHY-P96YLMU-A1	PQHY-P96YLMU-A1	PQHY-P120YLMU-A1	PQHY-P120YLMU-A1
	Heat Source unit 2	PQHY-P72YLMU-A1	PQHY-P72YLMU-A1	PQHY-P96YLMU-A1	PQHY-P96YLMU-A1	PQHY-P120YLMU-A1
Twinning pipe Kit(optional parts)		CMY-Y100CBK3				
Indoor unit-Twinning pipe	Liquid	a	ø15.88(5/8)			
	Gas	b	ø28.58(1-1/8)			
Twinning pipe-Heat Source unit 1	Liquid	c	ø9.52(3/8)			ø12.7(1/2)
	Gas	d	ø19.05(3/4)	ø22.2(7/8)		
Twinning pipe-Heat Source unit 2	Liquid	e	ø9.52(3/8)			ø12.7(1/2)
	Gas	f	ø19.05(3/4)	ø22.2(7/8)		

DIMENSIONS: PQHY-P72YLMU-A1

- Note1. Seal around the water piping, the refrigerant piping, the power supply, and the control wiring and plug unused knockout holes with putty, etc., to prevent moisture or dirt from entering cabinet.
- Note2. At the time of product shipment, the front side piping serves as the local drainage connection. When connecting on the rear side, please remove the rear side plug sealing corks, and attach on the front side. Ensure there is no leak in piping system once connected.
- Note3. See Fig. A and Fig. B for service clearances.
- Note4. If piping is installed in front of the unit, provide clearances as shown in Fig. A and Fig. B.
- Note5. Environmental condition for installation: -20~40°C(DB) (-4~104°F) for indoor installation.
- Note6. In case the temperature around the heat source unit has possibility to drop under 0°C(32°F), be careful for the following point to prevent the pipe burst by the water pipe freeze-up.
 •Circulate the water all the time even if heat source unit is not in operation and provide glycol for freeze protection.
 •Drain the water from inside of the heat source unit when the heat source unit will not operate for a long term.
- Note7. Ensure that the drain piping is downward with a pitch of more than 1/100.
- Note8. At brazing of pipes, wrap the refrigerant service valve with wet cloth and keep the temperature of refrigerant service valve under 120°C(248°F).

Unit : mm(in)

<Accessories>

- Refrigerant (Liquid) conn. pipe 1pc. (P72/P96/P120 ; Packaged in the accessory kit)
- Refrigerant (Gas) conn. elbow 1pc. (P72/P96/P120 ; Packaged in the accessory kit)
- Water stopper(Liquid,Gas) 1pc. each (P72/P96/P120 ; Packaged in the accessory kit)
- Sealing material for water stopper (Liquid,Gas) 1pc. each (P72/P96/P120 ; Packaged in the accessory kit)
- Sealing material for field piping (Liquid,Gas) 1pc. each (P72/P96/P120 ; Packaged in the accessory kit)
- Sealing material for drain socket 1pc. (P72/P96/P120 ; Packaged in the accessory kit)
- Pipe cover for gas 1pc. (P72/P96/P120 ; Packaged in the accessory kit)

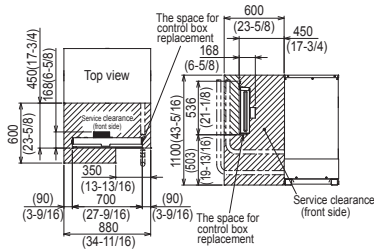
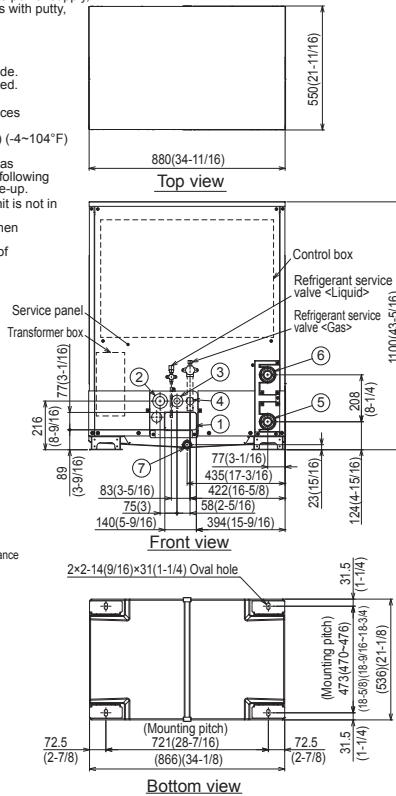

Fig. A

Fig. B

Model	Diameter			
	Refrigerant pipe		Service valve	
	Liquid	Gas	Liquid	Gas
PQHY-P72YLMU-A1	ø9.52 Brazeed (3/8) 1"	ø19.05 Brazeed (3/4) 1 1/4"		
PQHY-P96YLMU-A1	ø9.52 Brazeed (3/8) 1"		ø9.52 (3/8)	ø25.4 (1)
PQHY-P120YLMU-A1	ø12.7 Brazeed (1/2) 2 1/4"	ø22.2 Brazeed (7/8) 1 1/4"		

1. Connect by using the connecting pipes and elbow that are supplied.
 2. Total length ≥ 90m(295ft)
 3. Total length ≥ 40m(131ft)
 4. Use the pipe joint(field supply) and connect to the refrigerant service valve piping.



Top of unit casing not suitable for supporting system modules stacked above - field framing required for stacking modules of additional systems

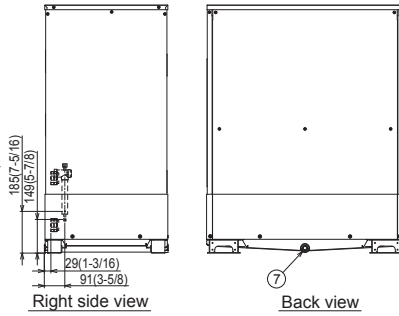

NO.	Usage	Specifications
①	For pipes	Front through hole 140 × 77 Knockout hole (5-9/16) (3-1/16)
②	For wires	Front through hole ø62.7 or ø34.5 Knockout hole (2-1/2) (1-3/8)
③		Front through hole ø43.7 or ø22.2 Knockout hole (1-3/4) (7/8)
④	For transmission cables	Front through hole ø34 Knockout hole (1-3/8)
⑤	Water pipe	inlet NPT1-1/2 Screw
⑥		outlet NPT1-1/2 Screw
⑦	Drain pipe	Rc3/4 Screw

DIMENSIONS: CMY-Y100CBK3 (TWINNING KIT)

Unit: in.

For Gas pipe:

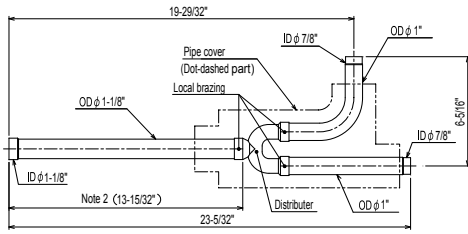

For Liquid pipe:

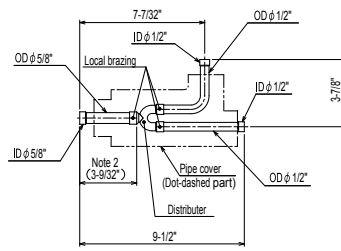

<Reducer(Accessory)>

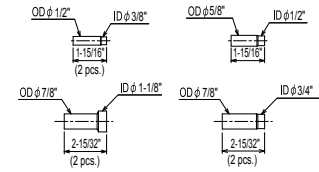

ID: Inner Diameter OD: Outer Diameter

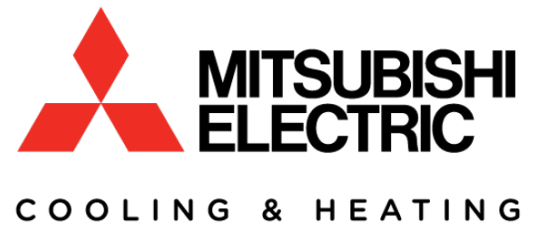

1340 Satellite Boulevard, Suwanee, GA 30024
Toll Free: 800-433-4822 www.mehvac.com

FORM# PQHY-P144YSLMU-A1 - 201708



Specifications are subject to change without notice.

Copyright © 2017 Mitsubishi Electric US, Inc.