

Job Name:	
System Reference:	Date:

MODULAR WATER-SOURCE VRF HEAT PUMP SYSTEM**FEATURES**

- Single modules up to 20 tons with the ability to combine single modules for systems up to 30 tons
- 208/230V, 3-Phase, 60Hz and 460V, 3-Phase, 60Hz options
- Designed for closed water loops
- Dual heat recovery - from water loop and refrigerant circuit
- 0-10V output signal to modulate water flow for compliance with energy codes
- Features Variable Evaporating Temperature (VET) technology, which enables the outdoor unit to raise the target evaporation temperature based on the difference between set point and return air temperature, saving energy.
- Water flow can be stopped while the unit is in a thermo-off state, saving on pump energy consumption.
For twinned systems, both modules must be thermo-off to stop water flow.
- Enhanced water-side heat exchanger design for improved efficiency and reduced risk of clogging
- Self-cooling cabinet design
- Inlet water temperature range: 23-113° F
- Max. Total Refrigerant Piping Length: up to 2,460 feet based on model
- Connects to CITY MULTI® indoor units; controlled via CITY MULTI® Controls Network (CMCN)
- External finish: Acrylic-painted steel
- Stack multiple units on a field-supplied rack to take advantage of vertical space when available
- Extended 10-year parts and compressor warranty available

ACCESSORIES

- Twinning Kit (required) (CMY-Q200CBK)
- Joint Kit (for details see Pipe Accessories Submittal)
- BC Controller (for details see BC Controller Submittal)

SPECIFICATIONS: PQRYP336YSLMU-A1

Specifications			System
Unit Type			PQRYP336YSLMU-A1
Nominal Cooling Capacity (460V)		Btu/h	336,000
Nominal Heating Capacity (460V)		Btu/h	378,000
Total Net weight of Modules		Lbs. (kg)	1,016 (460)
Electrical Power Requirements		Voltage, Phase, Hertz	460V, 3-phase, 60Hz
Piping Diameter (Brazed)			
From Twinning Kit to First Joint or Header (In. / mm)	Liquid pipe	In. (mm)	1-1/8 (28.58)
	Gas pipe	In. (mm)	1-5/8 (41.28)
Max. Total Refrigerant Line Length		Ft.	2,460
Max. Refrigerant Line Length (Between ODU & IDU)		Ft.	541
Max. Control Wiring Length		Ft.	1,640
Indoor Unit	Total capacity		50~150% of heat source unit capacity
	Model/Quantity		P06~P96/2~50 (Connectable branch pipe number is max. 48.)
Sound pressure level (measured in anechoic room)		dB(A)	59
Compressor Operating Range			8% - 100%
AHRI Ratings (Ducted/Non-Ducted)	EER		11.1 / 12.3
	IEER		16.8 / 20.1
	COP		4.66 / 5.23
	SCHE		19.7 / 19.0

Refer to Module Data^{*1}

Specifications			Module 1 ^{*1}	Module 2 ^{*1}
Unit Type			PQRYP168YLMU-A1	PQRYP168YLMU-A1
Nominal Cooling Capacity (460V)		Btu/h	168,000	168,000
Nominal Heating Capacity (460V)		Btu/h	188,000	188,000
Operating Temperature Range	Cooling (Indoor)	W.B.	59~75°F (15~24°C)	59~75°F (15~24°C)
	Heating (Indoor)	D.B.	59~81°F (15~27°C)	59~81°F (15~27°C)
Operating Water Temperature Range	Circulating water	°F	50~113°F (10~45°C)	50~113°F (10~45°C)
	Circulating water	°F	50~113°F (10~45°C)	50~113°F (10~45°C)
External dimension H x W x D		In.	57-1/8 x 34-11/16 x 21-11/16	57-1/8 x 34-11/16 x 21-11/16
		mm	1,450 x 880 x 550	1,450 x 880 x 550
Net weight		lbs. (kg)	508 (230)	508 (230)
External finish			Galvanized steel sheets	Galvanized steel sheets
Electrical Power Requirements		Voltage, Phase, Hertz	460V, 3-phase, 60Hz	460V, 3-phase, 60Hz
Minimum Circuit Ampacity		A	20	20

SPECIFICATIONS: PQRYP336YSLMU-A1

Specifications		Module 1 ^{*1}	Module 2 ^{*1}
Unit Type		PQRYP168YLMU-A1	PQRYP168YLMU-A1
Maximum Overcurrent Protection	A	35	35
Circulating Water (quality must meet regulations)			
Flow Rate	G/min (gpm)	31.7	31.7
	L/s	2	2
Pressure Drop	Ft.	14.7	14.7
	psi	6.38	6.38
Operation Volume Range	G/min (gpm)	19.8 ~ 50.9	19.8 ~ 50.9
	L/m	70 ~ 193	70 ~ 193
Maximum Water Pressure	MPa	2	2
	psi	290	290
Water-source Connection for Inlet and Outlet	In.	1-1/2 NPT	1-1/2 NPT
Piping Diameter (Brazed)			
From Modules to Twinning Kit [In.(mm)]	Liquid (High Pressure)	In. (mm)	7/8 (22.2)
	Gas (Low Pressure)	In. (mm)	1-1/8 (28.58)
Sound pressure level (measured in anechoic room)		dB(A)	56
Compressor Type x Quantity		Inverter scroll hermetic compressor x 1	Inverter scroll hermetic compressor x 1
Motor output	kW	11	11
Lubricant		MEL32	MEL32
Refrigerant		R410A x 11 lbs. + 1 oz. (5.0 kg)	R410A x 13 lbs. + 4 oz. (6.0 kg)
Protection Devices	High pressure protection	High pressure sensor, High pressure switch at 4.15 MPa (601 psi)	High pressure sensor, High pressure switch at 4.15 MPa (601 psi)
	Inverter circuit	Over-heat protection, Over-current protection	Over-heat protection, Over-current protection
	Compressor	Over-heat protection	Over-heat protection

*1 Each individual module requires a separate electrical connection. Reference electrical data for each individual module.

Notes:

DIMENSIONS: PQRYP336YSLMU-A1

Unit : mm(in)

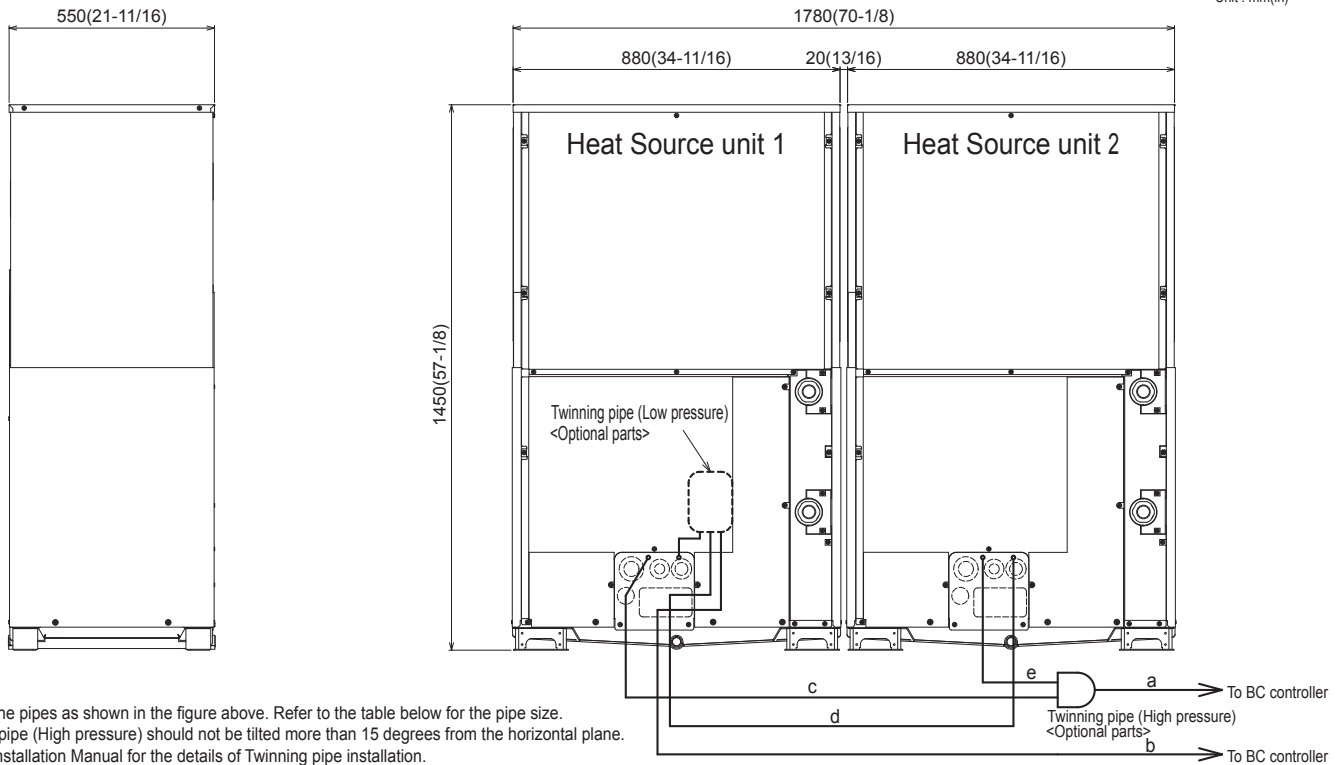

- Note 1. Connect the pipes as shown in the figure above. Refer to the table below for the pipe size.
 2. Twinning pipe (High pressure) should not be tilted more than 15 degrees from the horizontal plane.
 3. See the Installation Manual for the details of Twinning pipe installation.
 4. Only use the Twinning pipe by Mitsubishi (optional parts).

Twinning pipe connection size

Package unit name	PQRY-P288YSLMU-A1	PQRY-P312YSLMU-A1	PQRY-P336YSLMU-A1
Component unit name	Heat Source unit 1	PQRY-P144YLMU-A1	PQRY-P168YLMU-A1
	Heat Source unit 2	PQRY-P144YLMU-A1	PQRY-P168YLMU-A1
Twinning pipe Kit(optional parts)	CMY-Q200CBK		
BC controller~Twinning pipe	High pressure	a $\phi 28.58(1-1/8)$	
	Low pressure	b $\phi 34.93(1-3/8)$	$\phi 41.28(1-5/8)$

	Unit model	High pressure	Low pressure
		c or e	d
Twinning pipe~Heat source unit	P144 P168	$\phi 22.2(7/8)$	$\phi 28.58(1-1/8)$

DIMENSIONS: PQRY-P168YLMU-A1

Note1. Seal around the water piping, the refrigerant piping, the power supply, and the control wiring and plug unused knockout holes with putty, etc., to prevent moisture or dirt from entering cabinet.

Note2. At the time of product shipment, the front side piping serves as the local drainage connection.

When connecting on the rear side, please remove the rear side plug sealing corks, and attach on the front side. Ensure there is no leak in piping system once connected.

Note3. See Fig. A and Fig. B for service clearances.

Note4. If piping is installed in front of the unit, provide clearances as shown in Fig. A and Fig. B.

Note5. Environmental condition for installation: -20~40°C(DB) (-4~104°F) for indoor installation.

Note6. In case the temperature around the heat source unit has possibility to drop under 0°C(32°F), be careful for the following point to prevent the pipe burst by the water pipe freeze-up.

- Circulate the water all the time even if heat source unit is not in operation and provide glycol for freeze protection.
- Drain the water from inside of the heat source unit when the heat source unit will not operate for a long term.

Note7. Ensure that the drain piping is downward with a pitch of more than 1/100.

Note8. At brazing of pipes, wrap the refrigerant service valve with wet cloth and keep the temperature of refrigerant service valve under 120°C(248°F).

Unit : mm(in)

<Accessories>

- Refrigerant (high pressure) conn. pipe 1pc. (P144/P168/P192 ; Packaged in the accessory kit)
- Refrigerant (low pressure) conn. pipe 1pc. (P144/P168/P192 ; Packaged in the accessory kit)
- Water stopper 1pc. (P144/P168/P192 ; Packaged in the accessory kit)
- Sealing material for water stopper 1pc. (P144/P168/P192 ; Packaged in the accessory kit)
- Sealing material for field piping (high pressure, low pressure) 1pc. each (P144/P168/P192 ; Packaged in the accessory kit)
- Sealing material for drain socket 1pc. (P144/P168/P192 ; Packaged in the accessory kit)
- Pipe cover for low pressure 1pc. (P144/P168/P192 ; Packaged in the accessory kit)
- Sealing material for base leg (two types) 4pcs. each (P144/P168/P192 ; Packaged in the accessory kit)
- Sealing material for panel 1pc. (P144/P168/P192 ; Packaged in the accessory kit)

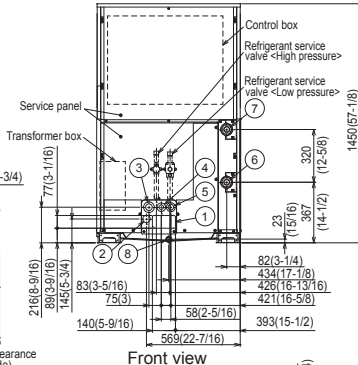
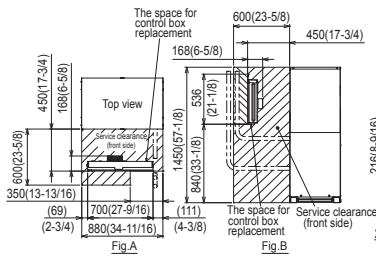
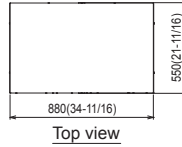

Top of unit casing not suitable for supporting system modules stacked above - field framing required for stacking modules of additional systems

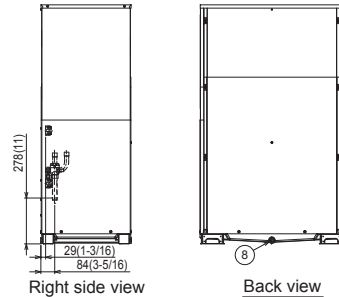

Connecting pipe specifications

Model	Refrigerant pipe		Service valve	
	High pressure	Low pressure	High pressure	Low pressure
PQRY-P144YLMU-A1	ø22.2 Braze	ø28.58 Braze	ø25.4 (1)	ø28.58 (1-1/8)
PQRY-P188YLMU-A1	(7/8) *1	(1-1/8) *1	(1)	(1-1/8)
PQRY-P192YLMU-A1				

*1. Connect by using the connecting pipes that are supplied.

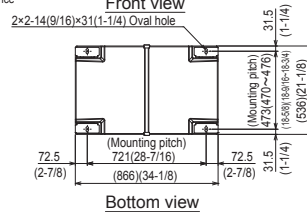

No.	Usage	Specifications
①	Front through hole	140 × 77 Knockout hole (5-9/16) (3-1/16)
②	For pipes	Front through hole (Uses when leveling kit (optional parts) is mounted.) ø45 Knockout hole (1-13/16)
③	For wires	Front through hole ø62.7 or ø34.5 Knockout hole (2-1/2) (1-3/8)
④	For transmission cables	Front through hole ø43.7 or ø22.2 Knockout hole (1-3/4) (7/8)
⑤	For transmission cables	Front through hole ø34 Knockout hole (1-3/8)
⑥	Water pipe inlet	NPT1-1/2 Screw
⑦	Water pipe outlet	NPT1-1/2 Screw
⑧	Drain pipe	Rc3/4 Screw

DIMENSIONS: CMY-Q200CBK (TWINNING KIT)

Unit : mm(in)

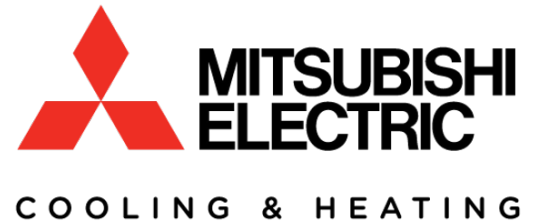
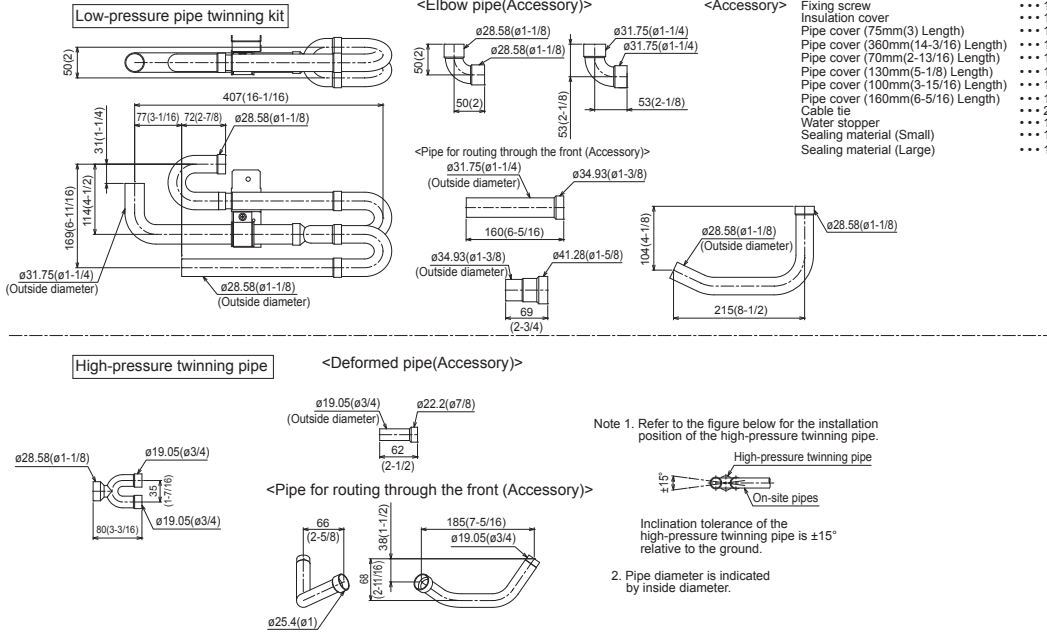

1340 Satellite Boulevard, Suwanee, GA 30024
Toll Free: 800-433-4822 www.mehvac.com



FORM# PQRY-P336YSLMU-A1 - 201710

Specifications are subject to change without notice.

Copyright © 2017 Mitsubishi Electric US, Inc.