

TYPE 2 - 487 SERIES (4-7/8" THROAT) W/ 1-1/2" FLUSH TRIM
GLASS BASE (FLOOR)

F1

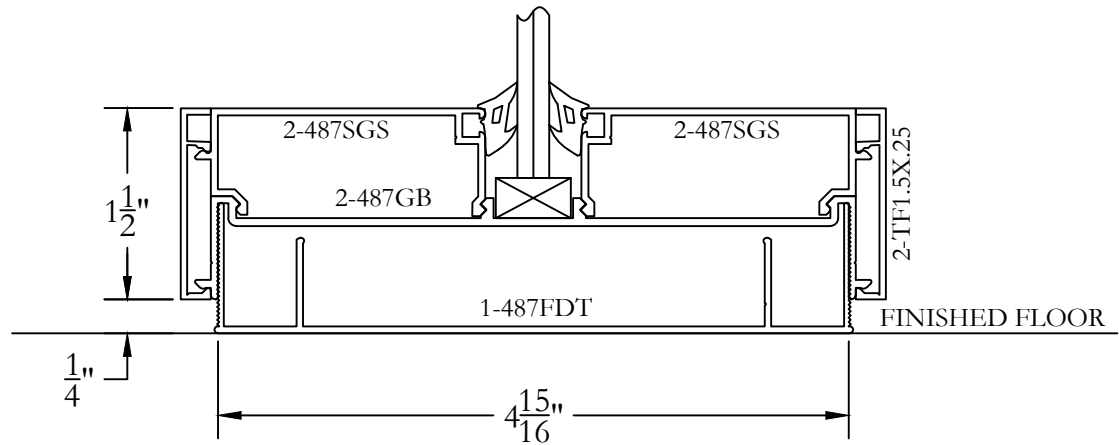

Bringing new light to interior architecture



Frameworks Manufacturing Phone: 713-692-5222
1910 Cypress Station Dr www.frameworks.com
Suite #100 email: orders@frameworks.com
Houston, Texas 77090