

## C5R

RIGID LED LINEAR COVE LIGHTING, MID-POWER  
INTEGRAL POWER SYSTEM



### APPLICATION

Low profile linear LED luminaire with integral line voltage power supply designed to accent small spaces such as coves and soffits plus wall washing capabilities with 35° x 80° or 60° x 115° optic options. Designed with modular CLiP<sup>®</sup> (Configurable Lighting Platform), C5R provides options to suit multiple application requirements without the need for external transformers or drivers.

### CONSTRUCTION

- 12in die cast aluminum modules with polycarbonate lenses are pre-assembled on an extruded aluminum track.
- Section lengths are available up to 6ft in 1ft increments and may be joined in the field for continuous runs up to 440 feet. (Nominal lengths. See dimensional information.)
- Quick wire connectors join sections.
- Multiple mounting clip options secure sections, including a 10° and 20° clip.
- CSA damp location listed.

### OPTICS / LENS / DIFFUSER

- Lightly frosted lens with optional 35° x 80° or 60° x 115° wall wash optics.

### POWER SYSTEM

- 120V or 277V input, integral, driverless technology.
- Total Harmonic Distortion <20%, Power Factor >0.9
- ELV dimming standard, 100-30% dimming range.
- 0-10V dimming with Dimming Interface Module (DIM-Z)

### PERFORMANCE

- 480 lm/ft (5w/ft) or 710 lm/ft (8w/ft) light output.
- Operating temperature range of -20°C to 50°C

### LIGHT CHARACTERISTICS

- White Color Correlated Temperatures: 2700K, 3000K, 3500K, 4000K
- 80+ Color Rendering Index
- Tempo's UniBin™ process ensures consistent hue and color to within a maximum 2-step MacAdam ellipse per section.

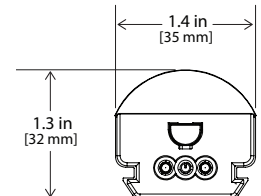

**Buy Tempo**  
**Buy American**



OF US AND IMPORTED COMPONENTS

### WARRANTY

Tempo provides a 5-year limited warranty.

### 86,000 HOURS

**L85 LUMEN MAINTENANCE**  
LED Luminaires will reach 85% of initial lumen output at or beyond 86,000 hours at 25°C.



### PERFORMANCE SUMMARY All data nominal. 3500K test data shown.

Watts/ft	5W/ft	8W/ft
Lumens/ft	480	710
Lumens/Watt	96	89
Maximum Run Length @ 120V	190 ft	115 ft
Maximum Run Length @ 277V	440 ft	275 ft

## C5R

RIGID LED LINEAR COVE LIGHTING, MID-POWER  
INTEGRAL POWER SYSTEM

### ORDERING INFORMATION

Example: C5R-LL-0-120E5-27NA-4

4ft, C5R, lightly frosted lens, 120V, ELV dimming, 5W/ft, 2700K, Natural Anodized

C5	R	Optic/Lens/Diffuser		Module Spacing	Voltage	Dimming	Watts/Foot	Color Temp	Finish	Fixture Length <sup>1</sup>
C5	R Rigid	<b>LL</b>	Lightly frosted lens (120° x 120°)	0 0"	<b>120</b> 120V	<b>E</b> ELV (Electronic Low Voltage) dim to 30%	<b>5</b> 5 W/ft <b>8</b> 8 W/ft	<b>27</b> 2700K <b>30</b> 3000K <b>35</b> 3500K <b>40</b> 4000K	<b>NA</b> Natural Anodized <b>CC</b> Paint to match color chip	
		<b>3580</b>	Half dome lens + 35° x 80° wall wash optic		<b>277</b> 277V					
		<b>60115</b>	Half dome lens + 60° x 115° wall wash optic							

(1) Fixture length measured in feet. No half foot options.

### DIMENSIONAL INFORMATION

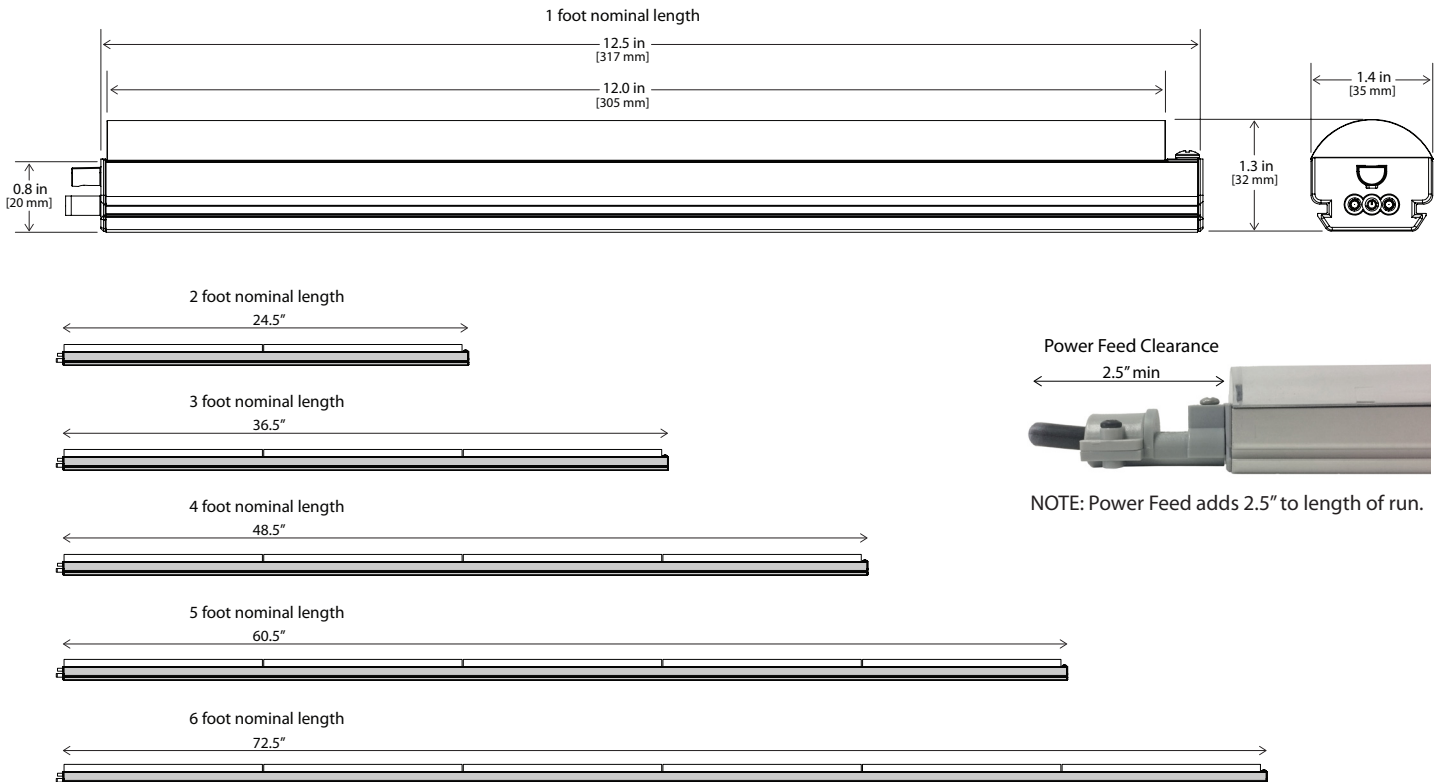

## C5R

RIGID LED LINEAR COVE LIGHTING, MID-POWER  
INTEGRAL POWER SYSTEM

### SYSTEM INTEGRATION ACCESSORIES

SURGE SUPPRESSION DEVICE Tempo furnished surge suppression device must be installed on each supplying branch circuit to comply with 5-year warranty		
	<b>SSD-120</b>	120V Branch Circuit
	<b>SSD-277</b>	277V Branch Circuit
POWER FEED CABLES Additional lengths available, contact factory		
	<b>PFC5-F-UNV-36</b>	Female Connector, 120-277V, 36 inches
JUMPER FEED CABLES Additional lengths available, contact factory		
	<b>JFC5-MF-UNV-06</b>	Male/Female, 120-277V, 6 inches
	<b>JFC5-MF-UNV-12</b>	Male/Female, 120-277V, 12 inches
	<b>JFC5-MF-UNV-24</b>	Male/Female, 120-277V, 24 inches
	<b>JFC5-MF-UNV-48</b>	Male/Female, 120-277V, 48 inches
MOUNTING HARDWARE		
	<b>C4A-MTGBRKT</b>	Stainless Steel Surface Mounting Bracket (set of 12)
	<b>C4A-MTGBRKT-SURF</b>	Stainless Steel Surface Mounting Bracket with Screw Ears (set of 12)
	<b>C4A-MTGBRKT-COVE</b>	Stainless Steel Front Cove Mounting Bracket (set of 12)
	<b>C4A-MTGBRKT-WALL</b>	Plastic Wall Mounting Bracket (set of 12)
	<b>C4A-MTGBRKT-1020</b>	Plastic Surface Mounting Bracket with 10° or 20° angle (set of 12)
	<b>PA-5</b>	Plastic 90° Adjustable Mounting Bracket. Minimum of 2 required per section (set of 12)
DIMMING INTERFACE MODULE 600W Max at 120V; 1,350W Max at 277V		
	<b>DIM-Z</b>	Dimming Interface Module converts 0-10V dimming signal to ELV dimming output, 120 - 277 Universal Line Voltage input. (C5R has 100-30% Dimming Range.)

## C5R

RIGID LED LINEAR COVE LIGHTING, MID-POWER  
INTEGRAL POWER SYSTEM

### MOUNTING HARDWARE

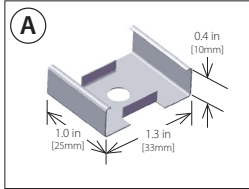

**A**  
SURFACE MOUNT  
(C4A-MTGBRKT)

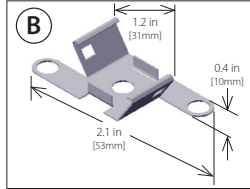

**B**  
SURFACE MOUNT W/  
SCREW MOUNTING EARS  
(C4A-MTGBRKT-SURF)

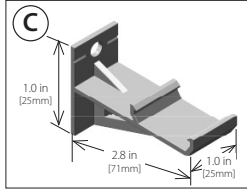

**C**  
WALL MOUNT  
(C4A-MTGBRKT-WALL)

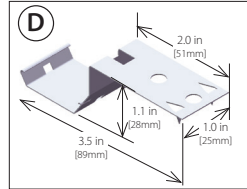

**D**  
COVE MOUNT  
(C4A-MTGBRKT-COVE)

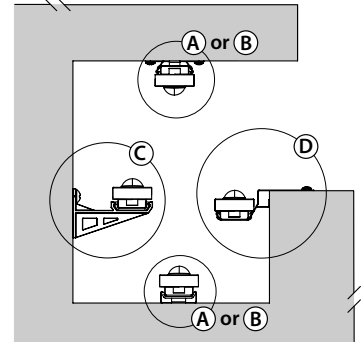

SURFACE MOUNTING BRACKET, 10° OR 20° ANGLE  
(C4A-MTGBRKT-1020)

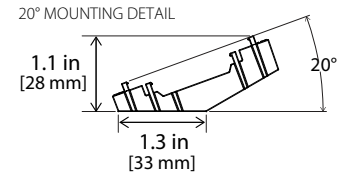
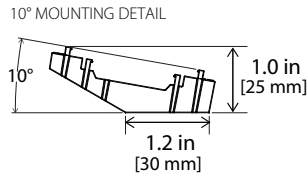
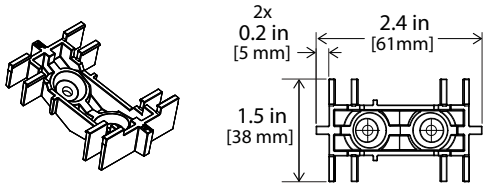

ADJUSTABLE MOUNTING BRACKET, 90°+ ANGLE  
(PA-5)

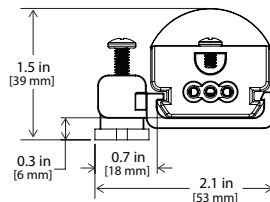
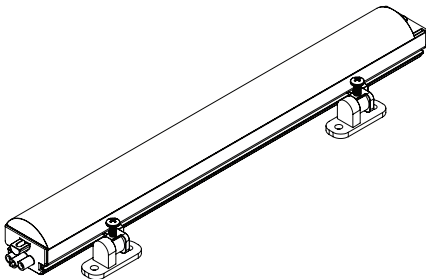
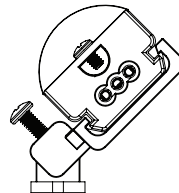
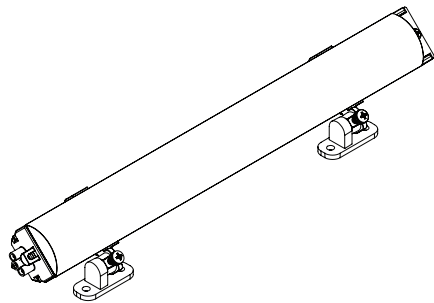

Tempo Industries reserves the right to change materials or modify the design of its product without notification as part of the company's continuing product improvement program. Please consult [www.tempollc.com](http://www.tempollc.com) for the most up-to-date specifications and technical data.