

C4R

RIGID LED LINEAR COVE LIGHTING, MID-POWER
24V REMOTE POWER SYSTEM



APPLICATION

C4R LED linear lighting produces uniform illumination designed to accent and highlight small spaces such as coves and soffits. Designed with modular CLiP[®] (Configurable Lighting Platform), C4R provides options to suit multiple application requirements.

CONSTRUCTION

- Thermally optimized die cast aluminum housing
- Available in 1 foot to 6 foot sections in 1 foot increments. 6 inch “caboose” also available.
- Sections quick connect together to form extended runs
- Easily replaceable LED arrays
- Multiple mounting clip options including 10° & 20° angle clip and Aluminum 90° rotation bracket.
- CSA damp location listed

OPTICS / LENS / DIFFUSER

- Lightly frosted lens with 120° x 120° distribution.

POWER SYSTEM

- Utilizes remote, low voltage (24V) DC power supply. Power supplies must be installed in an approved enclosure (by others) in close proximity to luminaire. See Driver Remote Distance Chart for guidance.
- Triac dimming to 1%
0-10V dimming to under 10%
DMX/RDM dimming to 1%
Non-dimming also available

PERFORMANCE

- 7W/ft light output up to 812 lm/ft
- 5W/ft light output up to 575 lm/ft
- Dense Pack (DP) LED spacing places more LED's closer together in each 6" module for high uniformity illumination.
- Operating temperature range of -20°C to 50°C
- Power Supply Total Harmonic Distortion <20%, Power Factor >0.9

LIGHT CHARACTERISTICS

- Typical CRI of 80+ in 2000K to 5000K.
- 90+ CRI option available with 2700K, 3000K and 3500K.
- Static Red, Green or Blue available. (5W/ft model only.)
- LED's are selected and placed on the printed circuit boards via Tempo Industries' UniBin™ process which ensures consistent hue and color within the entire run. Color variations are held to a minimum, within a 2-step MacAdam ellipse.

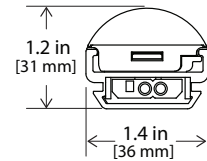

Buy Tempo
Buy American

MADE IN USA
OF US AND IMPORTED COMPONENTS

WARRANTY

Tempo provides a 5-year limited warranty.

86,000 HOURS

L85 LUMEN MAINTENANCE
LED Luminaires will reach 85% of initial lumen output at or beyond 86,000 hours at 25°C.



C4R

RIGID LED LINEAR COVE LIGHTING, MID-POWER
24V REMOTE POWER SYSTEM

PERFORMANCE SUMMARY

All data nominal. 3500K test data shown.

Watts/ft	5	7
Lumens/ft	575	812
Lumens/Watt	124	117

Static Colors

Watts/ft	5	7
RED Lumens/ft	116	N/A
RED Lumens/Watt	23	N/A
GREEN Lumens/ft	318	N/A
GREEN Lumens/Watt	64	N/A
BLUE Lumens/ft	88	N/A
BLUE Lumens/Watt	18	N/A

DRIVER REMOTE DISTANCE

	Wire Gauge	Maximum Lead Length
24VDC Driver	18 AWG	15ft (4.5m)
	16 AWG	25ft (7.5m)
	14 AWG*	40ft (12m)
	12 AWG*	60ft (1m)

* Terminal blocks on the drivers accept 18AWG or 16AWG wire. To use wire gauges larger than 16AWG connect up to 3 ft of 18AWG or 16AWG, then connect 14AWG or 12AWG with UL approved wire nuts up to the maximum lead length in the above table.

MAXIMUM RUN LENGTHS (5W/FT BASE MODEL)

24V Driver	Module Spacing	Watts/ft	Max Distance
100W	0" (Standard)	5.0	20ft
	2"	3.7	26ft
	3"	3.3	30ft
60W	0" (Standard)	5.0	12ft
	2"	3.7	15ft
	3"	3.3	18ft
40W	0" (Standard)	5.0	8ft
	2"	3.7	10ft
	3"	3.3	12ft

MAXIMUM RUN LENGTHS (7W/FT BASE MODEL)

24V Driver	Module Spacing	Watts/ft	Max Distance
100W	0" (Standard)	7.0	14ft
	2"	5.3	19ft
	3"	4.7	21ft
60W	0" (Standard)	7.0	8ft
	2"	5.3	11ft
	3"	4.7	12ft
40W	0" (Standard)	7.0	5ft
	2"	5.3	7ft
	3"	4.7	8ft

C4R

RIGID LED LINEAR COVE LIGHTING, MID-POWER
24V REMOTE POWER SYSTEM

ORDERING INFORMATION

5W/FT BASE MODEL

Example: C4R-LL-0-5-27NA-4

4ft, C4R, lightly frosted lens, 24V 5W/Ft, 2700K, Natural Anodized

C4	R	LL	Module Spacing	Watts/Foot	Color Temp	Finish	Fixture Length ¹
Se-ries	Platform	Optic/Lens/Diffuser					
C4	R Rigid	LL Lightly frosted lens	0 0" (Std)	5 5W/ft	20 2000K (CRI 80+) 22 2200K (CRI 80+) 27 2700K (CRI 80+) 30 3000K (CRI 80+) 35 3500K (CRI 80+) 40 4000K (CRI 80+) 50 5000K (CRI 80+) RD Red GR Green BL Blue 27H 2700K High CRI (90+) 30H 3000K High CRI (90+) 35H 3500K High CRI (90+)	NA Natural Anodized (Std.) CC Paint to match color chip	
			2 2"	37 3.7W/ft			
			3 3"	33 3.3W/ft			

NOTES:

(1) Fixture length measured in feet with maximum of 6 feet per run. 6 inch "Caboose" also available - enter ".5" for 6 inch fixture length.

7W/FT BASE MODEL

Example: C4R-LL-0-7-27NA-4

4ft, C4R, lightly frosted lens, 24V 7W/Ft, 2700K, Natural Anodized

C4	R	LL	Module Spacing	Watts/Foot	Color Temp	Finish	Fixture Length ¹
Se-ries	Platform	Optic/Lens/Diffuser					
C4	R Rigid	LL Lightly frosted lens	0 0" (Std)	7 7W/ft	20 2000K (CRI 80+) 22 2200K (CRI 80+) 27 2700K (CRI 80+) 30 3000K (CRI 80+) 35 3500K (CRI 80+) 40 4000K (CRI 80+) 50 5000K (CRI 80+) Static Colors N/A 27H 2700K High CRI (90+) 30H 3000K High CRI (90+) 35H 3500K High CRI (90+)	NA Natural Anodized (Std.) CC Paint to match color chip	
			2 2"	53 5.3W/ft			
			3 3"	47 4.7W/ft			

NOTES:

(1) Fixture length measured in feet with maximum of 6 feet per run. 6 inch "Caboose" also available - enter ".5" for 6 inch fixture length.

C4R

RIGID LED LINEAR COVE LIGHTING, MID-POWER
24V REMOTE POWER SYSTEM

SYSTEM INTEGRATION ACCESSORIES

POWER SUPPLIES - 24V Output		
Require approved enclosure (by others) in close proximity to luminaire. Consult factory for guidance.		
PWR-120-EM-040-T	120V AC Input, 24V DC Output, 40W, Triac Dimming (dim to 1%) Lutron Hi-lume 1% 2-wire LED driver, 120V forward phase - LTEA2W; 3.0"W x 1.0"H x 4.9" L	
PWR-120-EM-040-T1	120V AC Input, 24V DC Output, 40W, Triac Dimming (dim to 1%) Lutron Hi-lume 1% 2-wire LED driver, 120V forward phase - LTEA2W; 1.2"W x 1.0"H x 14.25" L	
PWR-UNV-EM-96-DMX	120-277V AC Input, 24V DC Output, 96W, DMX Dimming; 2.5"W x 1.25"H x 9.6" L	
PWR-UNV-EM-060	120-277V AC Input, 24V DC Output, 60W, Non-Dimming; 1.7"W x 1.2"H x 9.5" L	
PWR-UNV-EM-100	120-277V AC Input, 24V DC Output, 100W, Non-Dimming; 1.7"W x 1.2"H x 9.5" L	
PWR-UNV-EM-100-Z	120-277V AC Input, 24V DC Output, 100W, 0-10V Dimming (dim to under 10%); 1.9"W x 1.3"H x 9.2" L	
PWR-UNV-EM-100-Z-JB	Plenum Rated J-Box Driver, 120-277V AC Input, 24V DC Output, 100W, 0-10V Dimming (dim to under 10%); 2.5"W x 1.7"H x 12.4" L	
SURGE SUPPRESSION DEVICE		
A Tempo furnished surge suppression device must be installed on each supplying branch circuit to comply with Tempo's 5-year warranty terms		
SSD-120	120V Branch Circuit; 2.9"W x 1.75"H x 3.3" L	
SSD-277	277V Branch Circuit; 2.9"W x 1.75"H x 3.3" L	
POWER FEED CABLES Additional lengths available, contact factory		
PFC3-F-24-36	Female Connector, 24V, 36 inches	
PFC3-M-24-36	Male Connector, 24V 36 inches	
JUMPER FEED CABLES Additional lengths available, contact factory		
JFC3-FF-24-18	Female/Female Connector, 24V, 18 inches	
JFC3-MF-24-18	Male/Female, 24V, 18 inches	
JFC3-MM-24-18	Male/Male, 24V, 18 inches	
MOUNTING HARDWARE		
C4A-MTGBRKT	Stainless Steel Surface Mounting Bracket (set of 12)	
C4A-MTGBRKT-SURF	Stainless Steel Surface Mounting Bracket with Screw Ears (set of 12)	
C4A-MTGBRKT-COVE	Stainless Steel Front Cove Mounting Bracket (set of 12)	
C4A-MTGBRKT-WALL	Plastic Wall Mounting Bracket (set of 12)	
C4A-MTGBRKT-1020	Plastic Surface Mounting Bracket with 10° or 20° angle (set of 12)	
PA-5	Aluminum 90°+ Adjustable Mounting Bracket. (set of 12) Minimum of 2 required per section	

C4R

RIGID LED LINEAR COVE LIGHTING, MID-POWER
24V REMOTE POWER SYSTEM

DIMENSIONAL INFORMATION

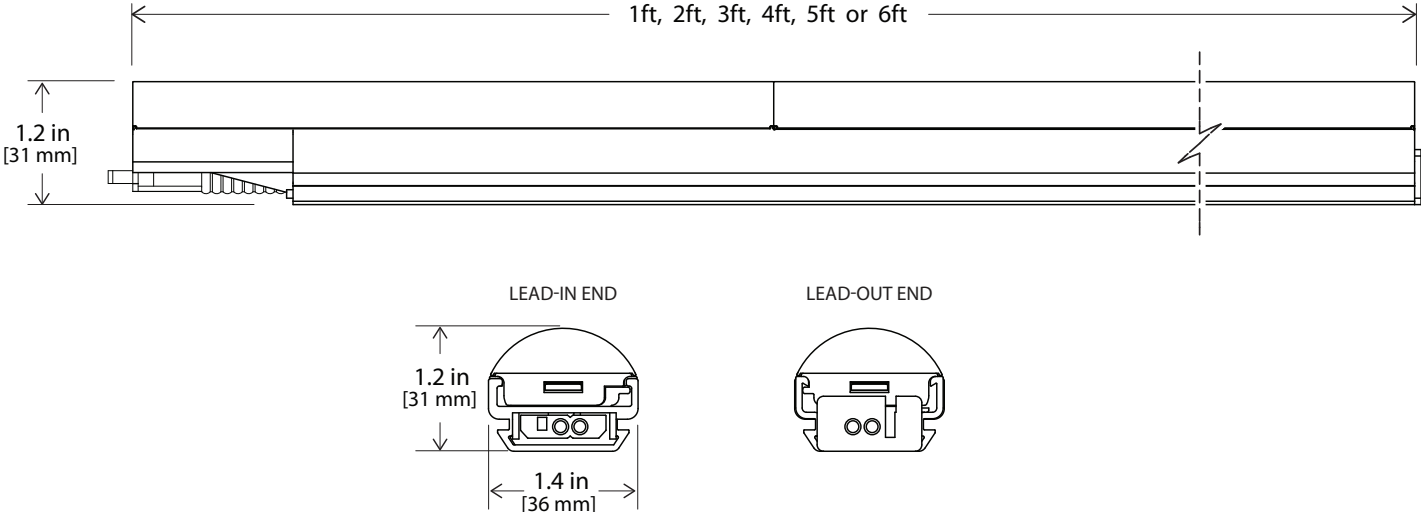

C4R

RIGID LED LINEAR COVE LIGHTING, MID-POWER
24V REMOTE POWER SYSTEM

MOUNTING HARDWARE

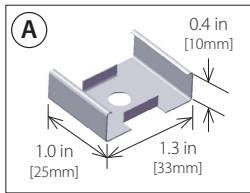

A
SURFACE MOUNT
(C4A-MTGBRKT)

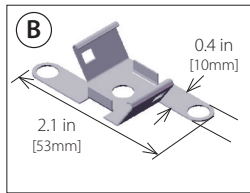

B
SURFACE MOUNT W/
MOUNTING EARS
(C4A-MTGBRKT-SURF)

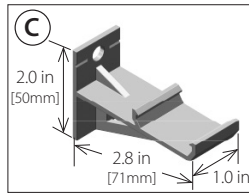

C
WALL MOUNT
(C4A-MTGBRKT-WALL)

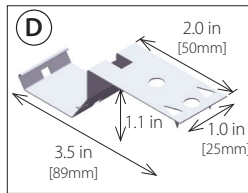

D
COVE MOUNT
(C4A-MTGBRKT-COVE)

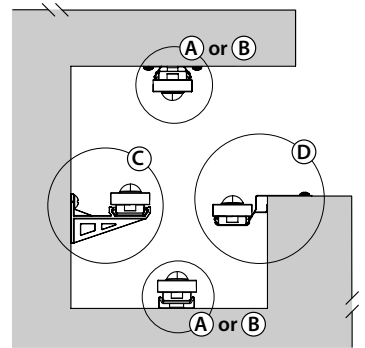

SURFACE MOUNT BRACKET, 10° OR 20° ANGLE
(C4A-MTGBRKT-1020)

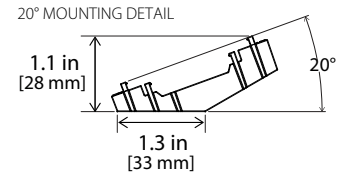
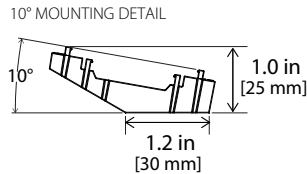
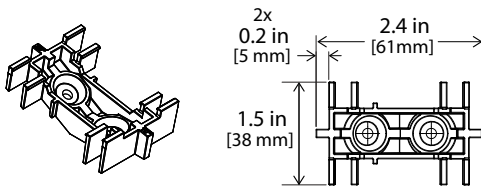

ADJUSTABLE MOUNTING BRACKET, 90°+ ANGLE
(PA-5)

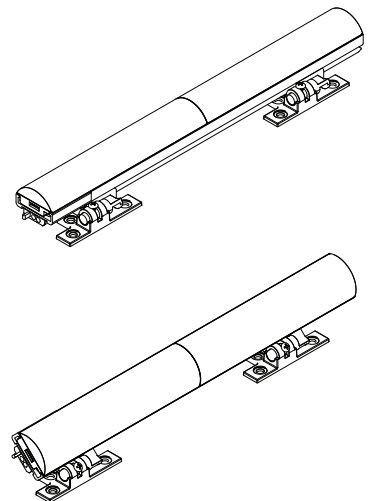
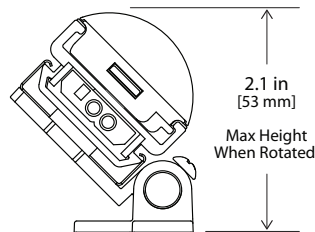
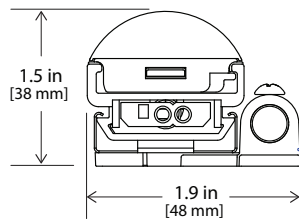
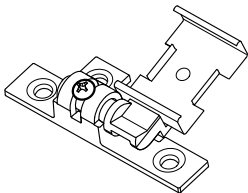

Tempo Industries reserves the right to change materials or modify the design of its product without notification as part of the company's continuing product improvement program. Please consult www.tempolc.com for the most up-to-date specifications and technical data.