

A

B

C

D

Lead-in End

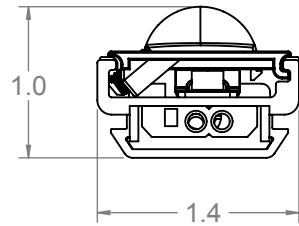

Lead-out End

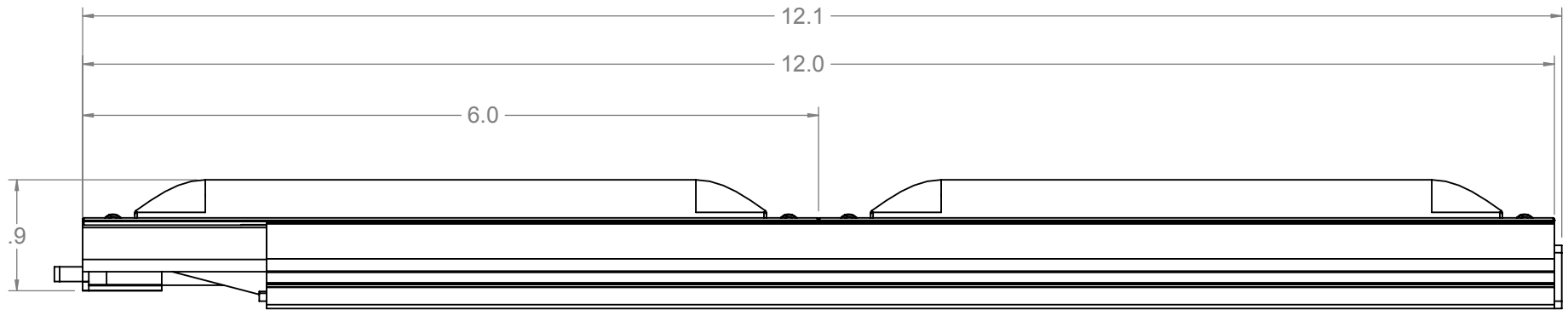
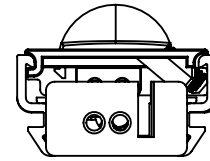

UNLESS OTHERWISE SPECIFIED:
 DIMENSIONS ARE IN INCHES
 TOLERANCES:
 ANGULAR: $\pm 1/2$ DEG
 DECIMAL: .X ± 0.030
 .XX ± 0.015
 .XXX ± 0.005
 HOLES: UNDER 0.500 ± 0.005
 OVER 0.501 ± 0.010

DO NOT SCALE DRAWING

MATERIAL

As Noted

FINISH

As Noted

NAME

JB

DATE

12/16/14

PRODUCT:

-



TITLE:

C4R00 Dust Lens with Connectors
AssemblySIZE
A

PART. NO.

REV
A

SCALE: 3:4

WEIGHT:

SHEET 1 OF 1

The information contained in this document is the sole property of Tempo Industries. Reproduction in part or as a whole without the written permission of Tempo Industries Inc., is prohibited.

A

B

C

D

Lead-in End

Lead-out End

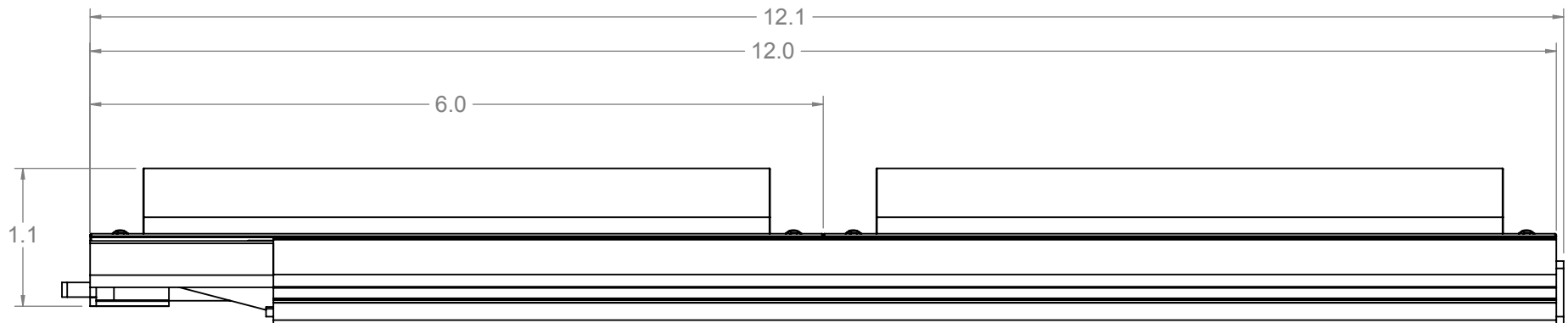
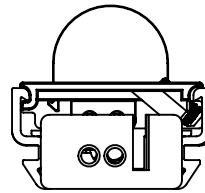
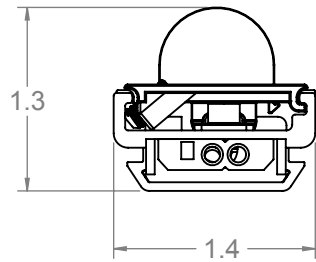

UNLESS OTHERWISE SPECIFIED:
 DIMENSIONS ARE IN INCHES
 TOLERANCES:
 ANGULAR: $\pm 1/2$ DEG
 DECIMAL: .X ± 0.030
 .XX ± 0.015
 .XXX ± 0.005
 HOLES: UNDER 0.500 ± 0.005
 OVER 0.501 ± 0.010

DO NOT SCALE DRAWING

MATERIAL
As NotedFINISH
As Noted

NAME

JB

DATE

12/16/14

PRODUCT:

-



TITLE:

C4R00-31 1/2 Dome Lens with
Connectors AssemblySIZE
A

PART. NO.

REV
A

SCALE: 3:4

WEIGHT:

SHEET 1 OF 1

The information contained in this document is the sole property of Tempo Industries. Reproduction in part or as a whole without the written permission of Tempo Industries Inc., is prohibited.

A

B

C

D

1

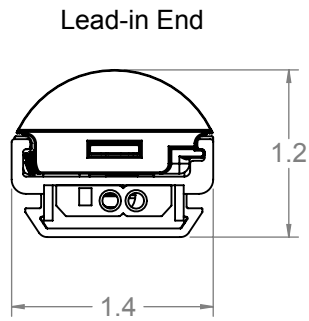

Lead-out End

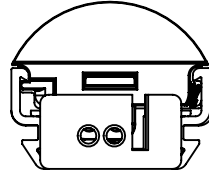

2

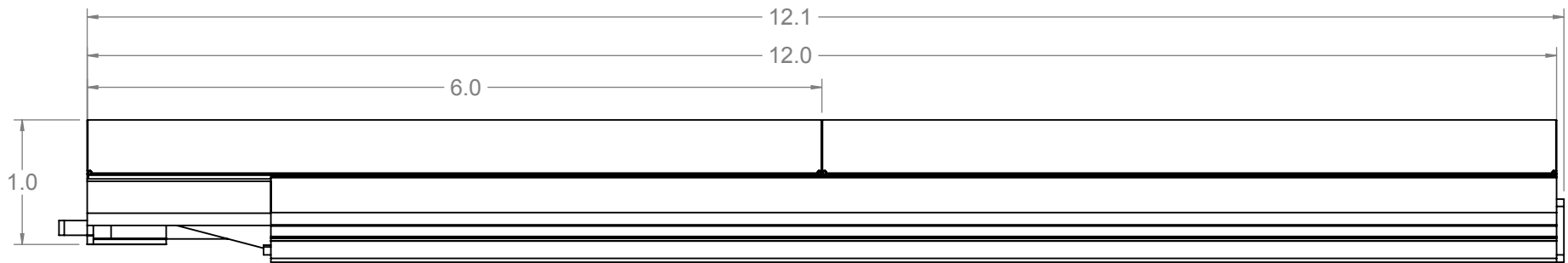

3

4

UNLESS OTHERWISE SPECIFIED:
DIMENSIONS ARE IN INCHES
TOLERANCES:
ANGULAR: $\pm 1/2$ DEG
DECIMAL: .X ± 0.030
.XX ± 0.015
.XXX ± 0.005
HOLES: UNDER 0.500 ± 0.005
OVER 0.501 ± 0.010

DO NOT SCALE DRAWING

MATERIAL
As NotedFINISH
As NotedNAME
JBDATE
12/16/14PRODUCT:
-

TITLE:

C4R05 Dome Lens with Connectors
AssemblySIZE
A

PART. NO.

REV
A

SCALE: 3:4

WEIGHT:

SHEET 1 OF 1

A

B

C

D

Lead-in End

Lead-out End

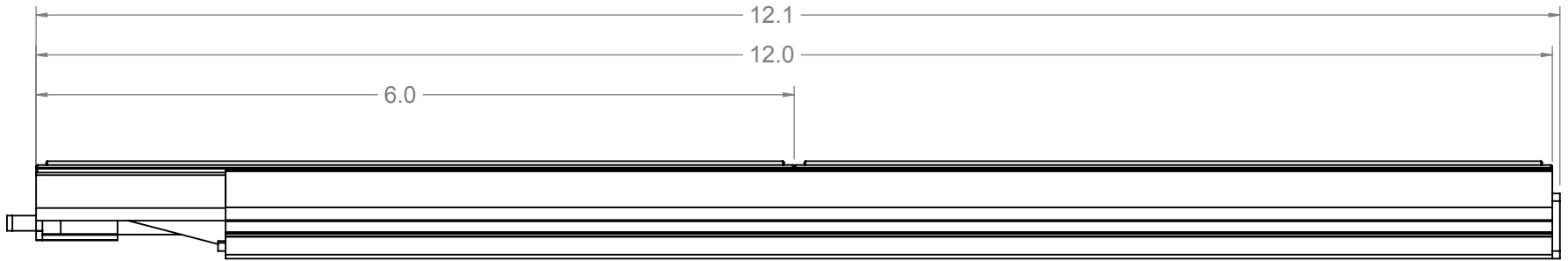
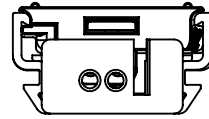
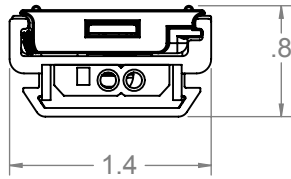

UNLESS OTHERWISE SPECIFIED:
 DIMENSIONS ARE IN INCHES
 TOLERANCES:
 ANGULAR: $\pm 1/2$ DEG
 DECIMAL: .X ± 0.030
 .XX ± 0.015
 .XXX ± 0.005
 HOLES: UNDER 0.500 ± 0.005
 OVER 0.501 ± 0.010

DO NOT SCALE DRAWING

MATERIAL
As Noted

FINISH
As Noted

	NAME	DATE	PRODUCT:
DRAWN	JB	12/16/14	-
CHECKED			
ENG APPR.			
MFG APPR.			
DERIVED FROM			
COMMENTS:	-		



TITLE:

C4R05 Flat Lens with Connectors Assembly

SIZE
A

PART. NO.

REV
A

SCALE: 3:4

WEIGHT:

SHEET 1 OF 1

The information contained in this document is the sole property of Tempo Industries. Reproduction in part or as a whole without the written permission of Tempo Industries Inc., is prohibited.