

pr1meFX

LINEAR AMBIENT LIGHTING
INTEGRAL POWER SYSTEM



APPLICATION

The wall mounted pr1meFX indirect linear luminaire is powerful enough to deliver the primary level of general illumination to a space. Patented optic system delivers over 85% of the light out of a perimeter cove supplying ideal light levels at the working plane. Provides indirect, glare free and shadow free light that is more visually comfortable than downlights or troffers. Intuitive and easy to install wall mount system does not require in-field aiming or adjusting.

Uniquely engineered to optimize the directionality of LED's, pr1meFX positions the fixture on the back wall of the cove, in line with the top edge of cove, for maximum efficiency. Designed to easily retrofit existing coves, integrate into new construction coves or for use with Tempo's pre-fabricated Square or Knife Edge cove system.

CONSTRUCTION

- Die cast aluminum heat sink and raceway.
- Pre-set 20° upward tilt requires no adjustment or aiming.
- Sold in 2 foot to 6 foot sections in 1 foot increments.
- Quick wire connectors join sections.
- PVC mounting rails 6 feet in length.
- 1 inch spacers between modules allow for telescoping length to fit any configuration
- Each module is micro-maintainable with an easy to replace LED board
- CSA damp location listed
- Masking included to allow installation prior to paint (must be removed before operation.)

OPTICS / LENS

- Molded polycarbonate lens cover
- Patented interior micro-reflector & molded baffle
- Produces asymmetric type beam spread that uses the ceiling reflectance to provide ambient light.

POWER SYSTEM

- 5w/ft or 8w/ft
- 120V or 277V input, integral, driverless technology.
- Total Harmonic Distortion <20%, Power Factor >0.9
- ELV dimming to 5%

PERFORMANCE

- Up to 712lm/ft light output
- Produces a uniform pattern specifically designed to deliver the first level of ambient light to a space.
- Optimized to eliminate hot spots in cove corners
- Operating temperature range of -20°C to 50°C

LIGHT CHARACTERISTICS

- White Color Correlated Temperatures: 2700K, 3000K, 3500K, 4000K
- 80+ Color Rendering Index
- Tempo's UniBin™ process ensures consistent hue and color to within a maximum 2-step MacAdam ellipse per section

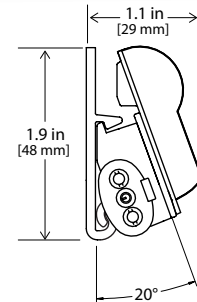

Pre-set 20° upward tilt

Buy Tempo
Buy American

MADE IN USA
OF US AND IMPORTED COMPONENTS

WARRANTY

Tempo provides a 5-year limited warranty.

86,000 HOURS

L85 LUMEN MAINTENANCE
LED Luminaires will reach 85% of initial lumen output at or beyond 86,000 hours at 25°C.



PERFORMANCE SUMMARY All data nominal. 3500K test data shown.

Watts/ft	120V, 5W/ft	120V, 8W/ft	277V, 5W/ft	277V, 8W/ft
Lumens/ft	477	712	461	688
Lumens/Watt	95	89	92	86
Maximum Run Length	190 ft	120 ft	440 ft	275 ft

pr1meFX

LINEAR AMBIENT LIGHTING

INTEGRAL POWER SYSTEM

ORDERING INFORMATION

Example: PFXC-CW-0-120E8-35WH-6

pr1meFX Cove, Ceiling Wash Optics, 120V, ELV dimming, 8W/ft, 3500K, White Finish, 6 foot

pFXC	CW	0		E			WH	
Series	Optic/Lens/Diffuser	Module Spacing	Voltage	Dimming	Watts/Foot	Color Temp	Finish	Section Length
pFXC Cove	CW Ceiling Wash	0 N/A	120 120V 277 277V	E ELV Electronic Low Voltage Dim to 5%	5 5 W/ft 8 8 W/ft	27 2700K 30 3000K 35 3500K 40 4000K	WH White	2 2 ft minimum 3 3 ft 4 4 ft 5 5 ft 6 6 ft maximum

SYSTEM INTEGRATION ACCESSORIES

MOUNTING HARDWARE FOR RETROFIT LINEAR FIXTURE (NO COVE PROFILE)		
PFX-SM	Surface Mounting Rail for Retrofit Coves and Coves by Others. 6 ft section	
POWER FEED CABLES Additional lengths available, contact factory		
PFFPX-F-36	Female connector, 36 in.	
PFFPX-M-36	Male connector, 36 in.	
JUMPER FEED CABLES Additional lengths available, contact factory		
JFPFX-MF-12	Female/Male connector, 12 in.	
JFPFX-MF-18	Female/Male connector, 18 in.	
JFPFX-MF-24	Female/Male connector, 24 in.	
SURGE SUPPRESSION DEVICE A Tempo furnished surge suppression device must be installed on each supplying branch circuit to comply with 5-year warranty		
SSD-120	120V Branch Circuit	
SSD-277	277V Branch Circuit	

PREFABRICATED COVE (See pr1meFX Cove System spec sheet for full details)

pr1meFX COVE SYSTEM, STANDARD SQUARE PROFILE		
PFXSC-01-K8	Standard Cove Profile Kit sold and shipped in 8 foot increments. Includes 8' Wall Mount Rail, 8' Cove Profile, 7 Support Brackets, 2 Joiner Inserts, Mounting Hardware	
PFXSC-02-CC	Standard Cove Profile - Inside Corner Coffin, 12" x 12" length	
PFXSC-02-CR	Standard Cove Profile - Outside Corner Raft, 12" x 12" length	
PFXSC-03-L	Standard Cove Profile - Left End Cap, 12" length	
PFXSC-03-R	Standard Cove Profile - Right End Cap, 12" length	

pr1meFX

LINEAR AMBIENT LIGHTING

INTEGRAL POWER SYSTEM

RETROFIT OPTION

FOR USE WITH COVE SUPPLIED BY OTHER

Retrofit pr1meFX luminaire into existing coves or install in new construction coves that are supplied by other. Extruded 1.9 inch tall PVC rail mounts directly to the wall to support the luminaire in retrofit applications or for new coves built in the field. The mounting rail can be installed before or after new cove is constructed. See Installation Details spec for minimum dimensions required.

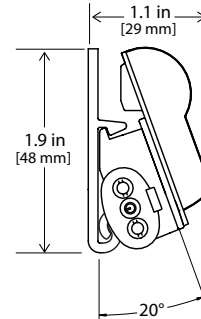

TEMPO PRE-FABRICATED COVE OPTION

INTUITIVE AND EASY TO INSTALL MODULAR COVE SYSTEM

The pr1meFX Cove System is the solution to the high cost of in-field cove construction. Mounts directly to the wall and does not require drywall, framing and finishing greatly reducing installation costs. The PVC material is suitable for spackling and painting before or after the luminaire is installed. Inside corners, outside corners, and end caps are available to finish the project.

Sold and shipped in 8 foot linear kits that include joiners and support brackets. Prefabricated 90° inside corners (coffer) and outside corners (raft) are available plus end caps for ending runs if needed.

STANDARD SQUARE PROFILE

3" tall by 4" wide extruded PVC in 8 foot lengths.

CONSTRUCTION

- Extruded white PVC wall mounting rail and cove profile. Durable and difficult to break, PVC is not as hard as aluminum allowing it to slightly flex and adapt to wall surfaces that are not completely flat.
- Molded white ABS support arms and joiners
- Matching white PVC corners and end caps available
- Mounting hardware provided for drywall installation
- Designed specifically for the Tempo pr1meFX linear LED luminaire to provide the first layer of general/ambient lighting to a space
- pr1meFX linear LED sold separately

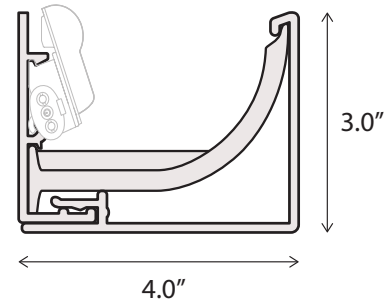

STANDARD SQUARE PROFILE

See the pr1meFX Cove System spec sheet for full details.

pr1meFX

LINEAR AMBIENT LIGHTING
INTEGRAL POWER SYSTEM

DIMENSIONAL INFORMATION

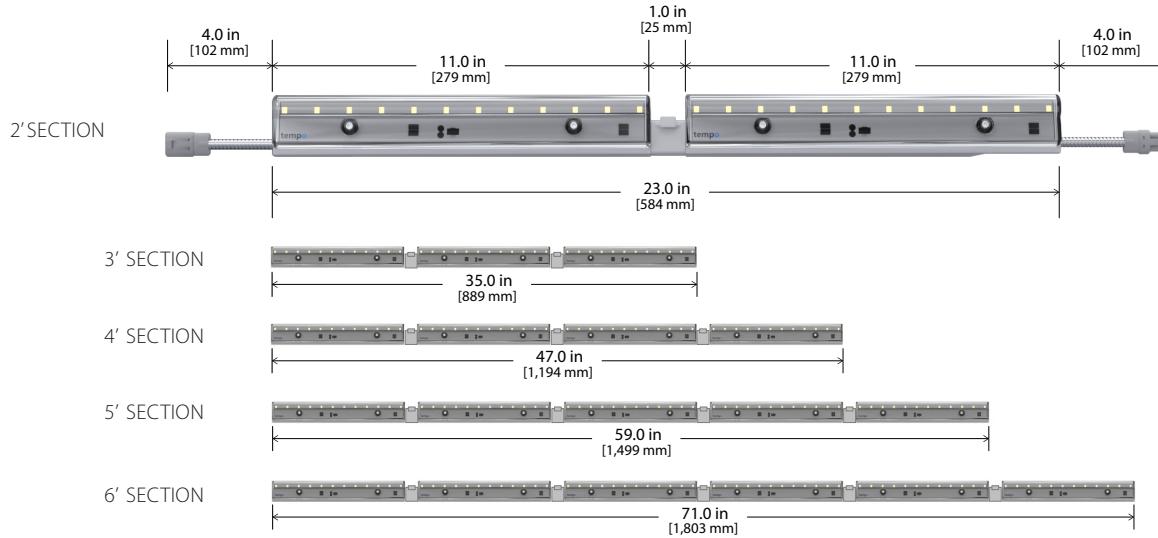

PERFORMANCE DATA

LARGE ROOM - 25' X 35' X 10'(h)
8W pr1meFX on two 35' sides
Foot candles at the working plane (30")

Average Foot Candles: 23.2
Ave/Min Ratio: 1.67
Total Feet of pr1meFX: 66' (33' each side)
Total Wattage: 528W
LPD: 0.58
C/W/F Reflectance: 0.86 / 0.80 / 0.20

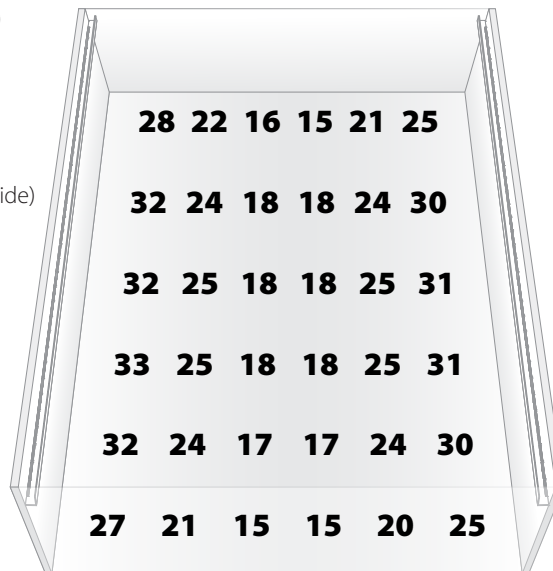

Hallway- 22' X 6' X 8'(h)
5W pr1meFX on one side
Foot candles at the floor

Average Foot Candles: 13.1
Ave/Min Ratio: 1.92
Total Feet of pr1meFX: 20'
Total Wattage: 100W
LPD: 0.38
C/W/F Reflectance: 0.86 / 0.80 / 0.20

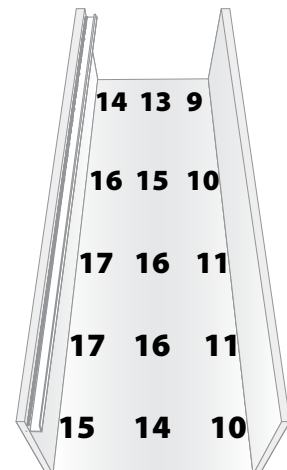

pr1meFX

LINEAR AMBIENT LIGHTING
INTEGRAL POWER SYSTEM

PERFORMANCE DATA

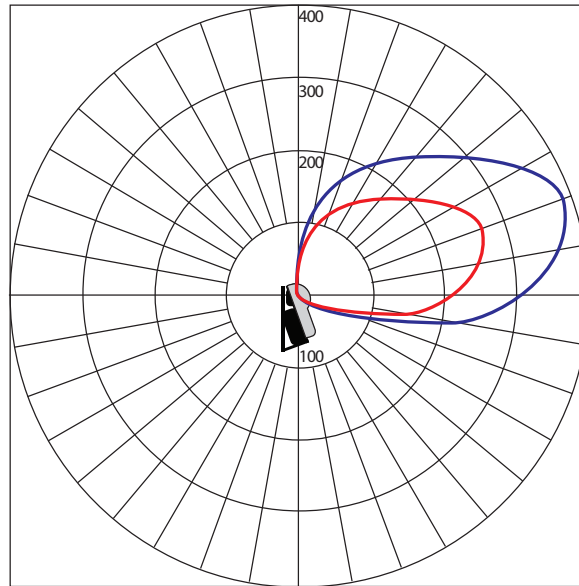

Typical 5 watt Polargraph
Typical 8 watt Polargraph

INSTALLATION DETAILS

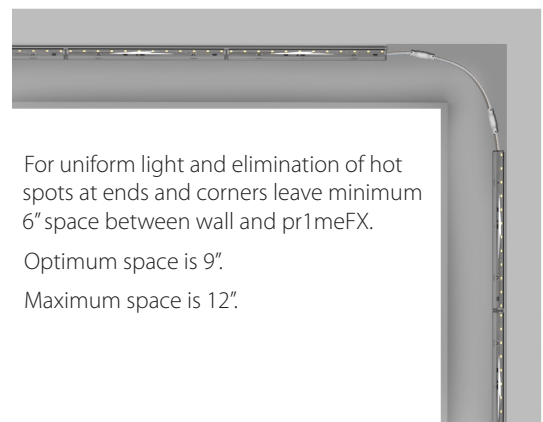
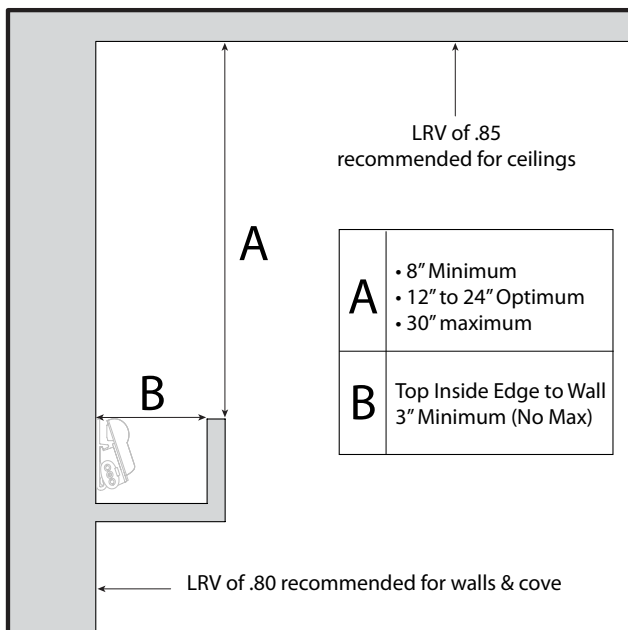

Tempo Industries reserves the right to change materials or modify the design of its product without notification as part of the company's continuing product improvement program. Please consult www.tempolc.com for the most up-to-date specifications and technical data.