

HLS House Lighting System

SURFACE MOUNT, 2-CIRCUIT
REMOTE POWER SUPPLY



APPLICATION

The House Lighting System (HLS) is designed to illuminate spaces requiring several lighting scenarios, such as theater or auditorium venues. Based on the Tempo CLiP® (Configurable Lighting Platform), luminaires may be configured with multiple 12" lighting modules, each with different light distributions and/or intensity. Modules may be controlled with separate circuits and dimming controls to further tailor scenes. A typical cinema application would include luminaires configured with High Lumen modules for theater cleaning and High Uniformity dimming modules for house lighting, trailer and movie screening.

The HLS is available in two different platforms, one designed for continuous surface or suspension mounting and the other for recessed mounting in a T-Bar ceiling grid (see separate spec sheet). HLS Surface Mount is available in 2 circuit configurations for small to medium auditoriums and 4 circuit for large auditoriums (see separate spec sheet). The low voltage, remotely powered system centralizes control and servicing.

CONSTRUCTION

- Extruded aluminum channel
- Thermally optimized die-cast aluminum light module housings
- Plug and play connectors for simplified installation
- CSA damp location listed

OPTICS / LENS / DIFFUSER

- High Lumen Cleaning Light modules (C) consist of a 12" module. A lightly frosted dome lens, coupled with wide beam optics direct a LED array.
- High Uniformity House Light modules (H) consist of a 12" module with a dome lens and high diffusion film over a high density array of LEDs.

POWER SYSTEM

- Utilizes remote, low voltage DC power supply, 120V
- When a combination of High Lumen Cleaning Light and high Uniformity House Light modules are specified, the standard wiring configuration is dual circuit, with all High Lumen (C) modules on one circuit and High Uniformity (H) on the second circuit.

PERFORMANCE

- Light output varies by configuration, see performance summary
- Lumen maintenance is greater than 85% at 86,000 hours for all product configurations (L85 at 86,000 hours)

LIGHT CHARACTERISTICS

- Available in 2200K, 2700K, 3000K, 3500K, 4000K correlated color temperature. A different color temperature may be selected for High Lumen Cleaning Light modules (C) and High Uniformity House Light modules (H).
- Typical CRI of 80+
- LED's are selected and placed on the printed circuit boards via Tempo Industries' UniBin® process which ensures consistent hue and color within the entire installation. Color variations are held to a minimum, within a 2-step MacAdam ellipse.

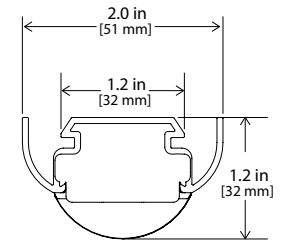

WARRANTY

Tempo provides a 5-year limited warranty. A 10-year limited warranty will apply when installed by a Tempo Certified Installer.



PERFORMANCE SUMMARY All data nominal

Module Configuration		Watts/Module	Delivered Lumens
C1	Cleaning Light Circuit Cleaning Light , 12" module, wide beam optics, LED array (3500K test data shown)	12 W	700 lm
H1	12" House Light Circuit House Light , 12" module, high uniformity dome lens, dense LED array (2700K test data shown)	10 W	720 lm

HLS House Lighting System

SURFACE MOUNT, 2-CIRCUIT

REMOTE POWER SUPPLY

ORDERING INFORMATION

Example: HLS-S-6-C135-H130-C135-BK

HLS	S	6	LIGHT MODULE CONFIGURATION*						Finish
Series	Mounting	Fixture Length	Module #1	Color Temp	Module #2	Color Temp	Module #3	Color Temp	Finish
House Lighting System 2 Circuit	S Surface Mount T-Bar	6 6 ft	C1 Cleaning Light (Circuit 1) H1 House Light (Circuit 2)	22 2200K 27 2700K 30 3000K 35 3500K 40 4000K	C1 Cleaning Light (Circuit 1) H1 House Light (Circuit 2)	22 2200K 27 2700K 30 3000K 35 3500K 40 4000K	C1 Cleaning Light (Circuit 1) H1 House Light (Circuit 2)	22 2200K 27 2700K 30 3000K 35 3500K 40 4000K	WH White BK Black
			For No Module, Leave Blank		For No Module, Leave Blank		For No Module, Leave Blank		

* C1 = Cleaning Light Circuit - High Lumen 12" Module, Wide Beam, Standard LED Array
H1 = House Light Circuit - High Uniformity 12" Module, Dense LED Array

SAMPLE CONFIGURATIONS



HLS-S-6-C135-H130-C135-BK

HLS 2 -Circuit Surface Mount 6 ft, C135 Cleaning Light, 12" module, 3500K; H130 House Light, 12" module, 3000K; C135 Cleaning Light, 12" module, 3500K, Black



HLS-S-6-C135-C135-BK

HLS 2 -Circuit Surface Mount 6 ft, C135 Cleaning Light, 12" module, 3500K; C135 Cleaning Light, 12" module, 3500K, Black

HLS House Lighting System

SURFACE MOUNT, 2-CIRCUIT

REMOTE POWER SUPPLY

SYSTEM INTEGRATION ACCESSORIES

POWER ENCLOSURE Power Supplies (maximum of 5) in 48" x 4" x 4" Enclosure		
	PWR-ENC - 24/X - 36T/Y -48	X = Quantity of 100W (24V, 120V input) Non-Dimming Power Supplies for Cleaning Light modules (A&C) Y = Quantity of 40W (36V, 120V input) Triac Dimming Power Supplies for House Light modules (B&D) Lutron Hi-lume 1% 2-wire LED driver (120V forward phase) - LTEA2W
	PWR-TDIM-100-24	Tri-Dim Triac dimming adapter, 120V input, 100W 24VDC driver output
	PWR-TDIM-200-24	Tri-Dim Triac dimming adapter, 120V input, 2 x 100W 24VDC driver outputs
	PWR-TDIM-100-36	Tri-Dim Triac dimming adapter, 120V input, 100W 36VDC driver output
	PWR-TDIM-200-36	Tri-Dim Triac dimming adapter, 120V input, 2 x 100W 36VDC driver outputs
WIREWAY		
	HLS-S-6-BK	HLS Surface Wireway, 2-Circuit, pre-wired, includes plug and play connectors, 6ft.
MOUNTING HARDWARE		
	HLS2-S-SPLICEBOX-M	HLS Surface Splice Box, 2-Circuit, pre-wired with quick connect connectors, male end feed
	HLS2-S-SPLICEBOX-F	HLS Surface Splice Box, 2-Circuit, pre-wired with quick connect connectors, female end feed
	HLS-S-PB-BK	HLS Surface Power Box, 2-Circuit, pre-wired with plug and play connector, includes cover plate, black
	HLS-S-JBOX	HLS Surface J-Box for mounting on continuous T-grid spine. Standard 2-gang j-box (by others) may be used when the power box is located within a tile
	HLS-S-MTGCLIP	HLS Surface Mount T-Bar Clips (QTY 12). Minimum of 2 clips every 6ft section (luminaire or wireway).
	HLS-S-MTGCLIP-EDGE	HLS Surface Mount T-Bar Edge Clips (QTY 12).
	HLS-S-MTGCLIP-SEISMIC	HLS Surface Mount T-Bar Clips (QTY 12) with Seismic Bracing Hanger.
POWER FEED CABLE		
	WIR-16-2BLU/2RED-PR	Plenum rated cable, 16 gauge, 4 wires – 2 Blue / 2 Red, 300ft per reel
SURGE SUPPRESSION DEVICE Tempo furnished surge suppression device must be installed on each branch circuit to comply with warranty terms.		
	SSD-120	120V Branch Circuit
	SSD-277	277V Branch Circuit
POWER INVERTERS Tempo's power inverters supply battery power backup to designated emergency lighting power supplies.		
	PWR-INV-125-120	Power Inverter, 125W, 120V Input/Output
	PWR-INV-250-120	Power Inverter, 250W, 120V Input/Output
	PWR-INV-375-120277	Power Inverter, 375W, 120V/120V or 277V/277V Input/Output

HLS House Lighting System

SURFACE MOUNT, 2-CIRCUIT

REMOTE POWER SUPPLY

DIMENSIONAL INFORMATION - SURFACE MOUNTED

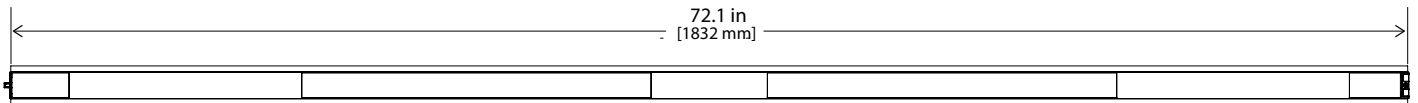
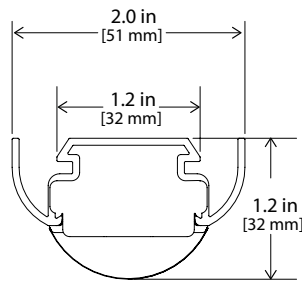

HLS House Lighting System

SURFACE MOUNT, 2-CIRCUIT
REMOTE POWER SUPPLY

DIMENSIONAL INFORMATION - MOUNTING HARDWARE

2-CIRCUIT SPLICE BOX SYSTEM

HLS2-S-SPLICEBOX-M/F

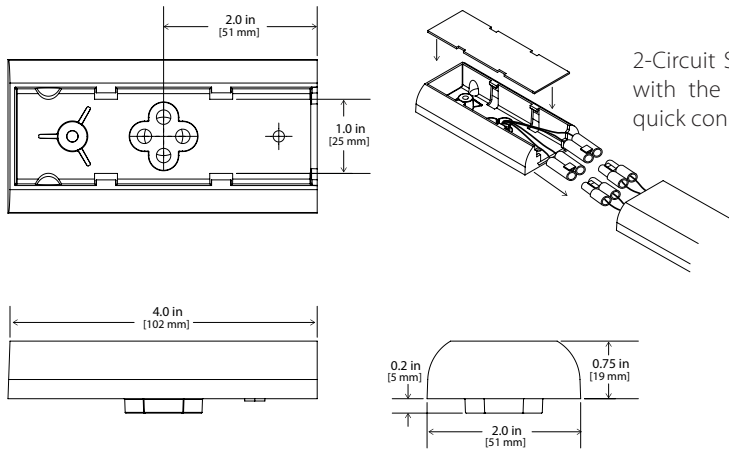

2-CIRCUIT J-BOX SYSTEM

HLS-S-PB

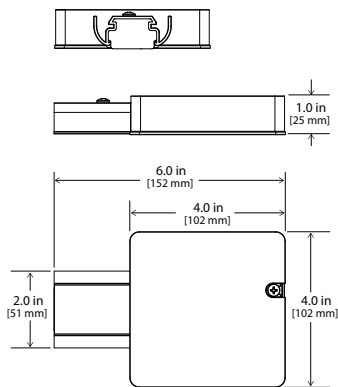

HLS-S-JBOX

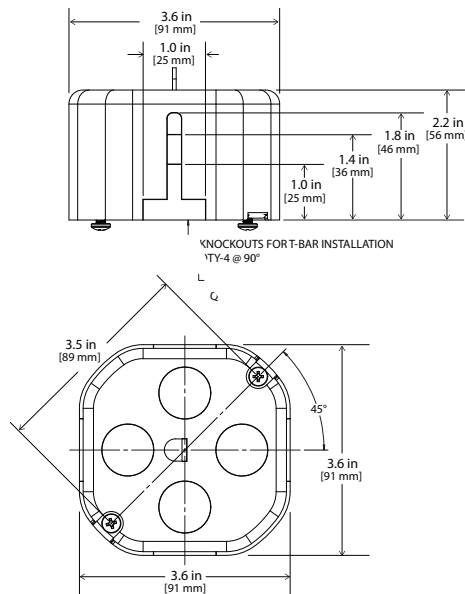

HLS-S-PB & HLS-S-JBOX ASSEMBLY

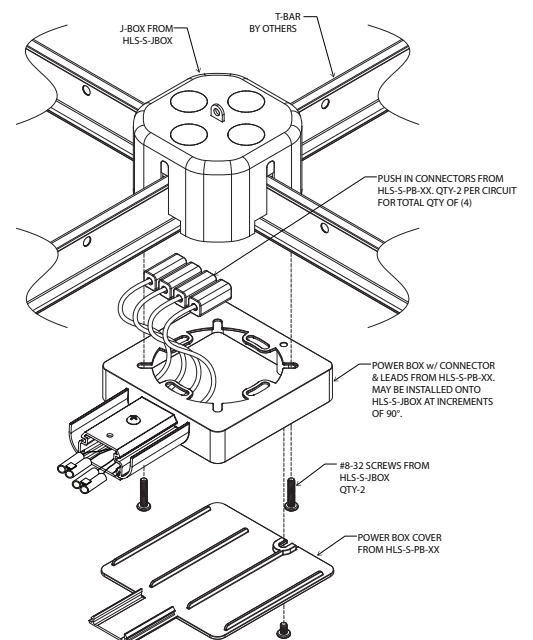

HLS House Lighting System

SURFACE MOUNT, 2-CIRCUIT

REMOTE POWER SUPPLY

MOUNTING HARDWARE

HLS-S-MTGCLIP

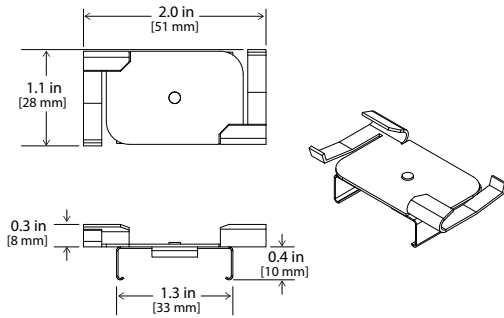

HLS-S-MTGCLIP-SEISMIC

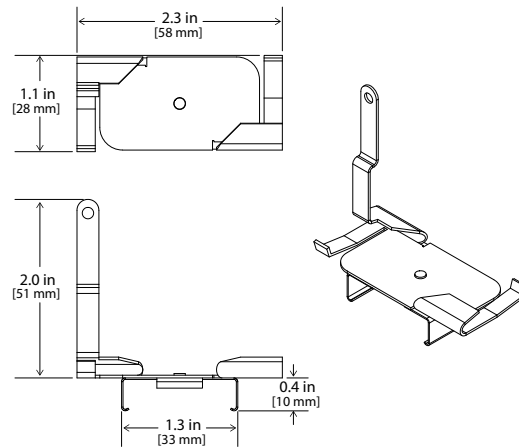

HLS-S-MTGCLIP-EDGE

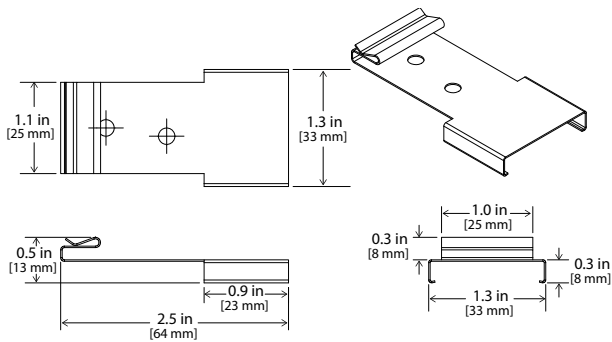

Tempo products and technologies are protected under one or more US and International patents.

Tempo reserves the right to change materials or modify the design of its product without notification as part of the company's continuing product improvement program. Please consult www.tempollc.com for the most up-to-date specifications and technical data.