

C3R

RIGID LED LINEAR ACCENT LIGHTING, LOW-POWER
REMOTE POWER SYSTEM



APPLICATION

C3R LED linear lighting produces uniform illumination designed to accent and highlight spaces such as small coves, under cabinets or millwork. Designed with modular CLiP[®] (Configurable Lighting Platform), C3R provides options to suit multiple application requirements. The rigid C3R may be connected to Tempo's serpentine C3S providing an elegant solution for combined curved and straight-run applications. DMX, 0-10V & Triac dimming options.

CONSTRUCTION

- Designed with non-ferrous components and mounting brackets. Meets MRI room requirements when used with brass mounting screws (part number C3A-MNTSCREW-BRS).
- Join sections and create continuous runs from one power supply.
- For combined curved and straight-run sections, C3R may be easily connected to Tempo's C3S linear serpentine system
- Easily replaceable LED printed circuit boards.
- Quick wire connectors to join sections.
- CSA damp location listed.

OPTICS / LENS / DIFFUSER

- Standard convex, lightly frosted lens
- Optional half round dome lens, 5% white

POWER SYSTEM

- Utilizes remote, Class II low voltage 12Volt or 24Volt Power Supply. Power supplies must be installed in an approved enclosure (by others) in close proximity to luminaire. See Driver Remote Distance Chart for guidance.
- Triac dimming to 1%
- 0-10V dimming to under 10%
- DMX/RDM dimming to 1%
- Non-dimming also available

PERFORMANCE

- CLiP™ - Configurable Lighting Platform module spacing options of 1", 2", 3", 4" & 5" for specific applications or to reduce total watts per foot.
- Light output ranges from 220 to 320 lm/ft based on Watts/ft selection
- Dense Pack (DP) LED spacing (3W/ft only) places more LED's closer together in each 3" module for high uniformity illumination.
- Operating temperature range of -20°C to 50°C
- Power Supply Total Harmonic Distortion <20%, Power Factor >0.9

LIGHT CHARACTERISTICS

- Available in 1600K, 2000K, 2200K, 2700K, 3000K, 3500K, 4000K, 5000K plus Red, Green, Blue and Amber
- Typical CRI of 80+, 90+ CRI option available with 2700K, 3000K and 3500K selection.
- All LED's are selected and placed on the printed circuit boards via Tempo Industries' UniBin™ process which ensures consistent hue and color within the entire run. Color variations are held to within a maximum of a 2-step MacAdam ellipse.

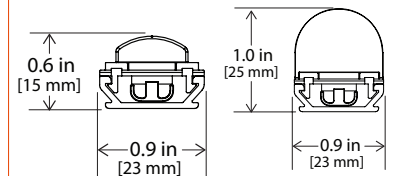

Buy Tempo
Buy American



WARRANTY

Tempo provides a 5-year limited warranty.

86,000 HOURS

L85 LUMEN MAINTENANCE
LED Luminaires will reach 85% of initial lumen output at or beyond 86,000 hours at 25°C.



Micro-Maintainable

Components, such as LED boards and lenses, can be easily replaced if necessary for increased product sustainability.



C3R

RIGID LED LINEAR ACCENT LIGHTING, LOW-POWER
REMOTE POWER SYSTEM

MAXIMUM RUN LENGTHS 12V MODEL

12V Driver	Module Spacing*	Watts/ft	Max Distance
60W	0" (Standard)	2.0	30ft
	1"	1.5	40ft
	2"	1.2	50ft
	3"	1.0	60ft
40W	0" (Standard)	2.0	20ft
	1"	1.5	24ft
	2"	1.2	30ft
	3"	1.0	40ft

* See page six for details on extended module spacing.

MAXIMUM RUN LENGTHS 24V MODEL

24V Driver	Module Spacing*	Watts/ft	Max Distance
100W	0" (Standard)	3.0	30ft
	1"	2.2	40ft
	2"	1.8	55ft
	3"	1.5	65ft
60W	0" (Standard)	3.0	18ft
	1"	2.2	24ft
	2"	1.8	32ft
	3"	1.5	40ft
40W	0" (Standard)	3.0	12ft
	1"	2.2	16ft
	2"	1.8	20ft
	3"	1.5	26ft

* See page six for details on extended module spacing.

PERFORMANCE SUMMARY

All data nominal. 3500K test data shown.

Watts/ft	2.0	3.0
Lumens/ft	220	320
Lumens/Watt	110	107

Static Colors

Watts/ft	2.0	3.0
RED Lumens/ft	49	83
RED Lumens/Watt	24	28
GREEN Lumens/ft	164	227
GREEN Lumens/Watt	82	75
BLUE Lumens/ft	40	63
BLUE Lumens/Watt	20	21
AMBER Lumens/ft	87	145
AMBER Lumens/Watt	44	48

DRIVER REMOTE DISTANCE

	Wire Gauge	Maximum Lead Length
12V Driver	18 AWG	10 ft (3m)
	16 AWG	15 ft (4.5m)
	14 AWG*	25 ft (7.5m)
	12 AWG*	40 ft (12m)

	Wire Gauge	Maximum Lead Length
24V Driver	18 AWG	15 ft (4.5m)
	16 AWG	25 ft (7.5m)
	14 AWG*	40 ft (12m)
	12 AWG*	60 ft (18m)

* Terminal blocks on the drivers accept 18AWG or 16AWG wire. To use wire gauges larger than 16AWG connect up to 3 ft of 18AWG or 16AWG, then connect 14AWG or 12AWG with UL approved wire nuts up to the maximum lead length in the above tables.

C3R

RIGID LED LINEAR ACCENT LIGHTING, LOW-POWER
REMOTE POWER SYSTEM

ORDERING INFORMATION

Example: **C3R-LL-0-3-27LG-4**

4ft, C3R, lightly frosted lens, 3 W/Ft, 2700K, Light Gray

C3	R					LG	
Series	Platform	Optic/Lens/Diffuser	Module Spacing ¹	Watts/Foot	Color Temp	Finish	Fixture Length ²
C3	R Rigid	LL Lightly frosted lens HD Half round dome lens, 5% White	0 0" (Std)	2 2.0W/ft 3 3.0W/ft	16 1600K 20 2000K 22 2200K 27 2700K 30 3000K 35 3500K 40 4000K 50 5000K RD Red (~625nm) GR Green (~545nm) BL Blue (~470nm) AM Amber (~590nm) 27H 2700K High CRI (90+) 30H 3000K High CRI (90+) 35H 3500K High CRI (90+)	LG Light Gray	
			1 1"	15 1.5W/ft 22 2.2W/ft			
			2 2"	12 1.2W/ft 18 1.8W/ft			
			3 3"	1 1.0W/ft 15 1.5W/ft			

NOTES:

(1) C3R features 3" modules with zero spacing in between as standard. Module Spacing options of 1", 2" or 3" in between each 3" module is available to reduce wattage per foot and reduce costs. See dimensional information for more details on Module Spacing.

(2) Fixture length measured in feet. For half foot increments enter .5 (Example: 5 feet, 6 inches will be 5.5)

C3R

RIGID LED LINEAR ACCENT LIGHTING, LOW-POWER
REMOTE POWER SYSTEM

SYSTEM INTEGRATION ACCESSORIES

POWER SUPPLIES - 12V Output for 2W/ft Standard LED Spacing Require approved enclosure (by others). See chart on page 2		
	PWR-120-EL-040-T	120V AC Input, 12V DC Output, 40W, Triac Dimming (dim to 1%) Lutron Hi-Lume 1% 2-wire LED driver, 120V forward phase; 3.0"W x 1.0" H x 4.9" L
	PWR-120-EL-040-T1	120V AC Input, 12V DC Output, 40W, Triac Dimming (dim to 1%) Lutron Hi-Lume 1% 2-wire LED driver, 120V forward phase; 1.2"W x 1.0" H x 14.25" L
	PWR-UNV-EL-060	120-277V AC Input, 12V DC Output, 60W, Non-Dimming; 1.7"W x 1.3"H x 8.4"L
	PWR-UNV-EL-060-Z	120-277V AC Input, 12V DC Output, 60W, 0-10V Dimming (dim to under 10%); 1.7"W x 1.3" H x 8.4" L

POWER SUPPLIES - 24V Output for 3W/ft Dense Pack LED Spacing Require approved enclosure (by others). See chart on page 2		
	PWR-120-EM-040-T	120V AC Input, 24V DC Output, 40W, Triac Dimming (dim to 1%) Lutron Hi-Lume 1% 2-wire LED driver, 120V forward phase; 3.0"W x 1.0" H x 4.9" L
	PWR-120-EM-040-T1	120V AC Input, 24V DC Output, 40W, Triac Dimming (dim to 1%) Lutron Hi-Lume 1% 2-wire LED driver, 120V forward phase; 1.2"W x 1.0" H x 14.25" L
	PWR-UNV-EM-100-N	120-277V AC Input, 24V DC Output, 100W, DMX/RDM Dimming; 3.2"W x 1.2"H x 9.1"L
	PWR-UNV-EM-100-N1	120-277V AC Input, 24V DC Output, 100W, DMX/RDM Dimming; 1.6"W x 1.2"H x 14.6"L
	PWR-UNV-EM-060	120-277V AC Input, 24V DC Output, 60W, Non-Dimming; 1.7"W x 1.2"H x 9.5"L
	PWR-UNV-EM-060-Z	120-277V AC Input, 24V DC Output, 60W, 0-10V Dimming (dim to under 10%); 1.7"W x 1.2" H x 9.5" L
	PWR-UNV-EM-100	120-277V AC Input, 24V DC Output, 100W, Non-Dimming; 1.7"W x 1.2" H x 9.5" L
	PWR-UNV-EM-100-Z	120-277V AC Input, 24V DC Output, 100W, 0-10V Dimming (dim to under 10%); 1.9"W x 1.3" H x 9.2" L
	PWR-UNV-EM-100-Z-JB	Plenum Rated J-Box Driver, 120-277V AC Input, 24V DC Output, 100W, 0-10V Dimming (dim to under 10%); 2.5"W x 1.7" H x 12.4" L

SURGE SUPPRESSION DEVICE A Tempo furnished surge suppression device must be installed on each supplying branch circuit to comply with 5-year warranty terms		
	SSD-120	120V Branch Circuit; 2.9"W x 1.75" H x 3.3" L
	SSD-277	277V Branch Circuit; 2.9"W x 1.75" H x 3.3" L

POWER FEED CABLES Additional lengths available, contact factory		
	PFC3-F-12-36	Female Connector, 12V for 2W/ft, Standard LED spacing, 36 inches
	PFC3-F-24-36	Female Connector, 24V, for 3W/ft, Dense Pack LED spacing, 36 inches

JUMPER FEED CABLES Additional lengths available, contact factory		
	JFC3-MF-12-18	Male/Female, 12V, 18 inches
	JFC3-MF-24-18	Male/Female, 24V, 18 inches

MOUNTING HARDWARE		
	C3A-MTGBRKT-SURF	Set of 25 plastic Mounting Clips (screws included) 18" maximum recommended spacing between mounting clips.
	C3A-MTGBRKT-SURF-20	Set of 25 plastic, 20° Mounting clips (screws included) 18" maximum recommended spacing between mounting clips.
	C3A-MTGBRKT-SHIELD	6 foot Aluminum mounting shield, clear anodized. Requires C3A-MTGBRKT-SURF brackets to install fixture into mounting shield. Contact factory for additional finish options.
	C3A-MNTSCREW-BRS	Non Ferrous Brass mounting screw only for C3R mounting clip. (Meets MRI room requirements)

C3R

RIGID LED LINEAR ACCENT LIGHTING, LOW-POWER
REMOTE POWER SYSTEM

DIMENSIONAL INFORMATION

WITH CONVEX LENS

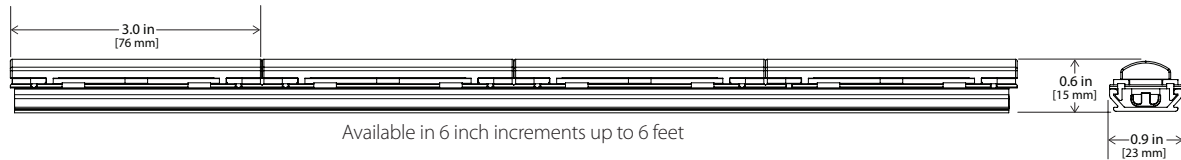

WITH HALF ROUND LENS

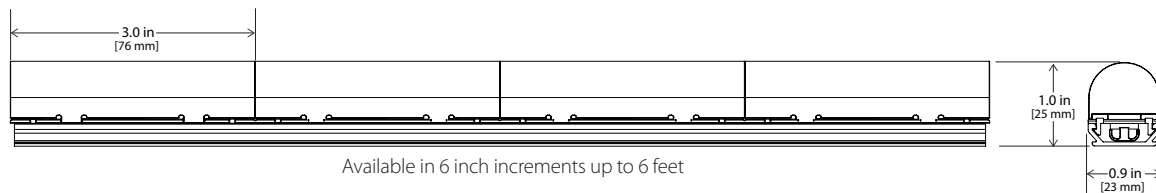

MOUNTING HARDWARE

C3A-MTGBRKT-SURF

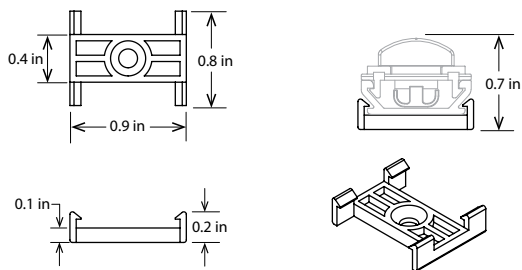

18" maximum recommended spacing between mounting clips.

C3A-MTGBRKT-SURF-20

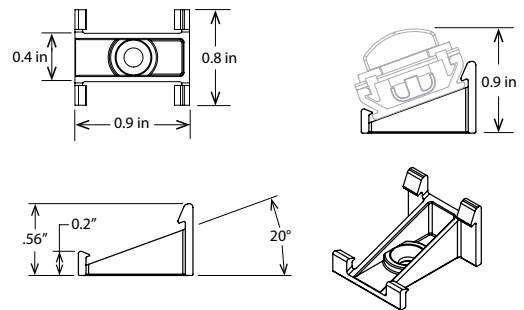

C3A-MTGBRKT-SHIELD

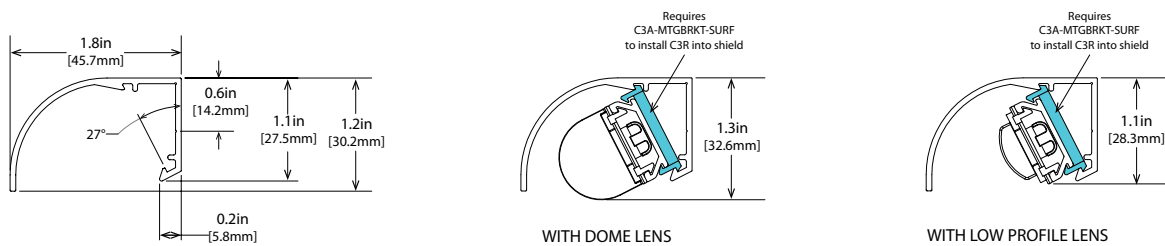

C3R

RIGID LED LINEAR ACCENT LIGHTING, LOW-POWER
REMOTE POWER SYSTEM

DIMENSIONAL & PERFORMANCE INFORMATION WITH EXTENDED MODULE SPACING

SHOWN WITH CONVEX LENS; SPACING ALSO AVAILABLE WITH HALF DOME LENS

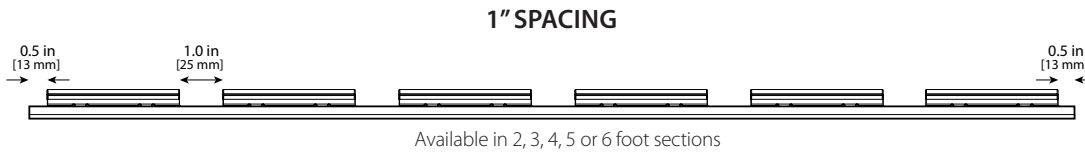

PERFORMANCE

All data nominal. 3500K test data

Model	12V	24V
Lumens/ft	165	240
Watts/ft	1.5	2.2

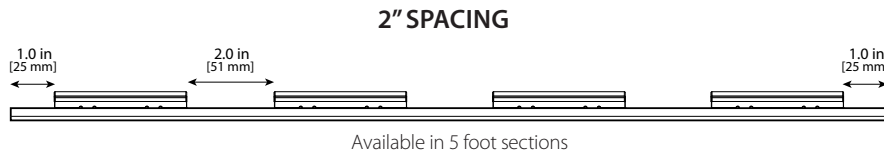

PERFORMANCE

All data nominal. 3500K test data

Model	12V	24V
Lumens/ft	138	200
Watts/ft	1.2	1.8

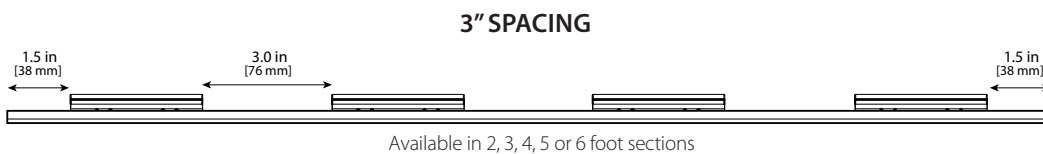

PERFORMANCE

All data nominal. 3500K test data

Model	12V	24V
Lumens/ft	110	160
Watts/ft	1.0	1.5

Tempo Industries reserves the right to change materials or modify the design of its product without notification as part of the company's continuing product improvement program. Please consult www.tempolc.com for the most up-to-date specifications and technical data.