



BEACON

978 UAT (ADS-B out)

INSTALLATION AND PILOT'S GUIDE

Revision table

Date	Revision	Comments	Section
July 22,2017	1.0	First Revision	
Nov 14, 2017	1.1	Adjustments by Ricardo L	8.2.4

Warranty

Levil Aviation warrants this product to the original purchaser to be free from defects in material and workmanship for a period of one year from the date of the original purchase. The following are not covered: software, damage resulting from accident, neglect, misuse, fire, or flood, improper voltage supply or failure to follow operational guidelines supplied with this product. Extended warranty is available for purchase on our website Please register your product online at: <http://aviation.levil.com>

IN NO EVENT, SHALL LEVEL AVIATION BE LIABLE FOR ANY INCIDENTAL, SPECIAL, INDIRECT OR CONSEQUENTIAL DAMAGES, WHETHER RESULTING FROM THE USE, MIUSE OR INABILITY TO USE THE PRODUCT OR FROM DEFECTS IN THE PRODUCT. SOME STATES DO NOT ALLOW THE EXCLUSION OF INCIDENTAL OR CONSEQUENTIAL DAMAGES, SO THE ABOVE LIMITATIONS MAY NOT APPLY TO YOU.



1.0 INTRODUCTION

The Beacon 978 series: A Smarter, Simpler ADS-B out. The Levil Beacon is an externally mounted pod in the shape of an aerodynamic antenna that contains all essential components necessary to comply with FAA’s requirement to have ADS-B out for 2020, when flying in controlled airspace. The design objective was to minimize **installation time** and **cost**, addressing the biggest challenges when trying to comply with the 2020 mandate. The Beacon’s unique design allows it to be mounted underneath the fuselage, which makes it compatible with most aircrafts. It minimizes **wiring time** by incorporating the following:

FEATURES	Beacon 978	Beacon 978G
Transponder “sniffer” to decode squawk code sent by existing transponders and relay the information through the ADS-B freq.		
position source (WAAS GPS) that satisfies with 14 CFR §91.227		
Pressure transducer for Pressure Altitude indication or comparison.		
Communication ports to connect LCD screen or other avionics		
ADS-B out transmitter (978 MHz UAT frequency) and antenna		

2.0 COMPLIANCE AND USE

ⓘ The BEACON 978 series is for use in Experimental and Light Sport Aviation only.

It meets the Minimum Operational Performance Standards of DO-282B Class A1S (transmit-only aircraft with single antenna) and the performance requirements of TSO-C154c. However, the BEACON 978 series is NOT TSO’d. You may only install the Beacon on aircraft with *Experimental Airworthiness Certificates*. For LSA owners, the installation must be performed in accordance with an applicable consensus standard (as an alteration) and authorized by the aircraft’s manufacturer.

3.0 TECHNICAL SPECIFICATIONS

Specification	Description
Transmission Frequency	978MHz
Transmission Power	20 Watts
Receiver Frequency	1090 MHz (auto squawk function)
Power Requirements	9-32 V
Power consumption	
Temperature Range	-30 C to +70 C
Max Altitude (Pressure)	27,000 ft
Max Altitude (GPS)	60,000 ft
Weight	8oz (Beacon) 4oz (LCD)
Length	5" (13 cm)
Height	4" (10 cm)
Width	2" (5 cm)
Horizontal Position Accuracy (GPS Only) ¹	≤ 6.5 meters RMS
Horizontal Position Accuracy (GPS + SBAS) ¹	≤ 4.0 meters RMS
Vertical Position Accuracy ¹	≤ 8.0 meters RMS
Velocity Accuracy ¹	≤ 0.1 meters / second RMS
System Design Assurance (SDA)	2
Source Integrity Level (SIL)	3
Patent	Pending

4.0 INSTALLATION

4.1 BEACON INSTALLATION

1. Remove Beacon from packaging. Hardware accessories (nuts, studs, aluminum plate) can be used for actual installation.
2. Use the aluminum plate to trace the pattern for holes on the belly of the aircraft or somewhere with clear view to the ground towers. Install the Beacon978 at least 3 feet away from other antennas, such as DME or transponder. If aircraft shell is not rigid enough, you may use the aluminum plate provided on the inside to provide more rigidity:

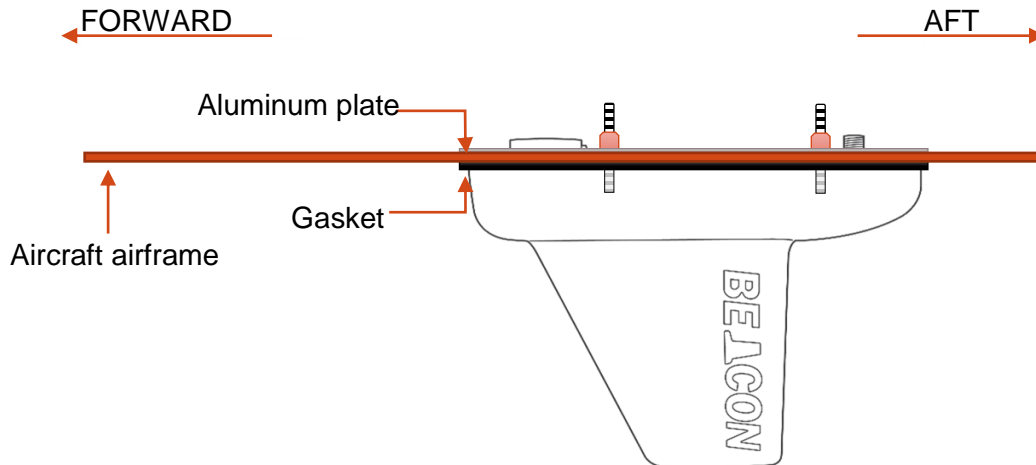

Note: If the aircraft is made of fiber glass or any other non-metallic material. A square foot aluminum plate must be placed on the inside of the aircraft on the base of the BEACON

3. GPS source. On Beacon model 978G, the GPS is embedded inside, so only an active antenna connection is necessary. On Beacon model 978, an external GPS source is required to be wired into the Cannon plug using RS232.
4. Follow the wiring diagrams below according to your Beacon model:

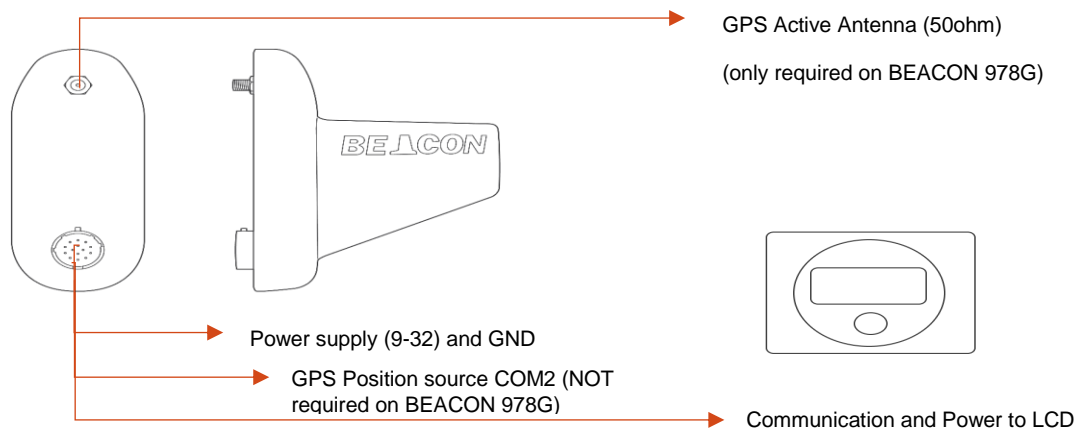

For Beacon978G:

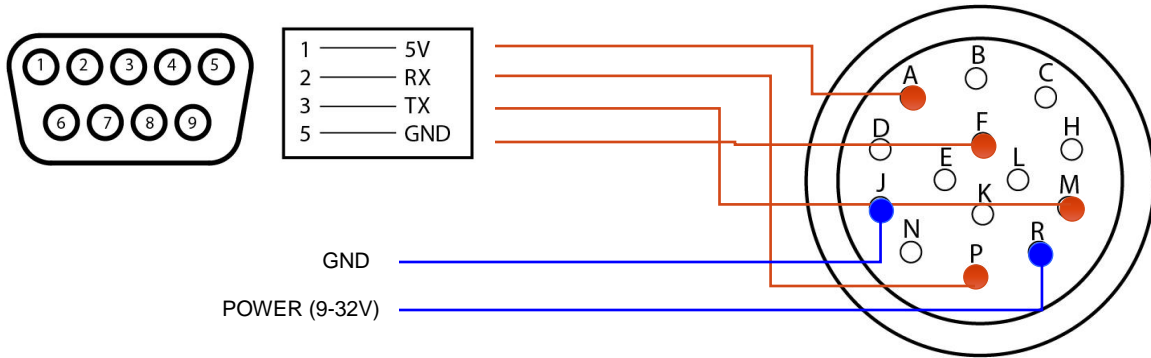

For Beacon978 (requires external GPS source):

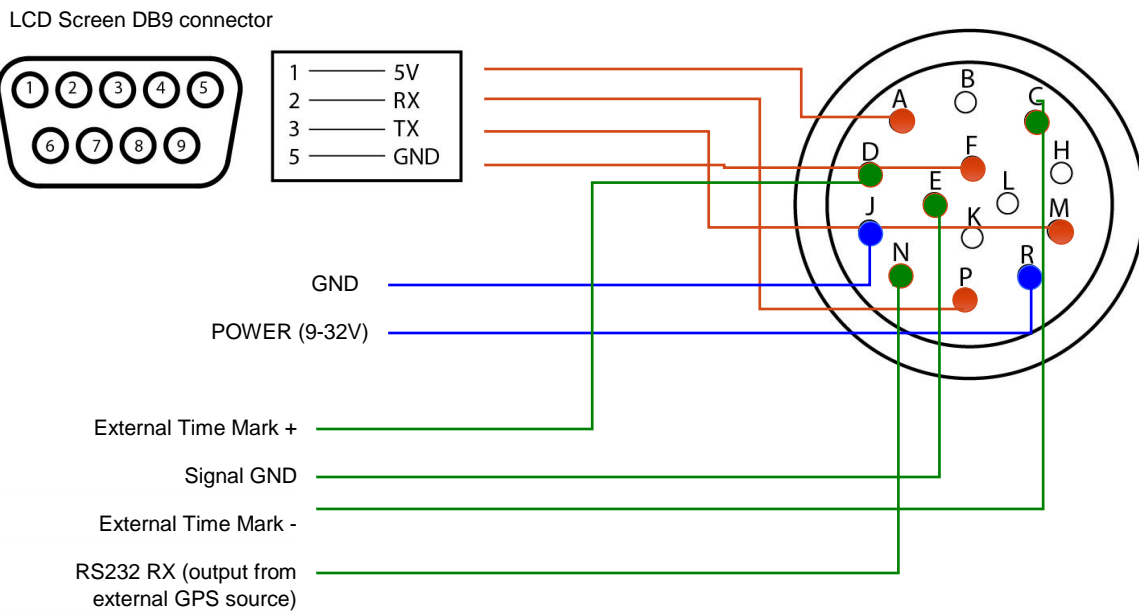

***PINS B, H, L and K are for future use, Do not connect.**

Note: cables sizes

- Power cable #18-20 (blue cables)
- Signal cable #22-24 (red cables)

Beacon Cheat Sheet

BEACON 978 CHEAT SHEET

Wiring for Cannon 14 pin plug

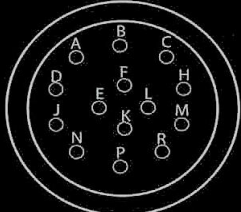

Wiring for DB9 plug



A	5V (PIN 1 LCD)
B	GPS TX
★ C	EXTERNAL TIME MARK (-)
★ D	EXTERNAL TIME MARK (+)
★ E	SIGNAL GND
F	GND (PIN 5 LCD)
H	COM 2 TX
J	POWER GND
K	COM 1 RX
L	COM 1 TX
M	RX TO (PIN 3 LCD, TX)
★ N	COM 2 RX
P	TX TO (PIN 2 LCD, RX)
R	INPUT VOLTAGE (9-32V)

★ = ONLY REQUIRED ON BEACON 978 (NO INTERNAL GPS)

- Register your Beacon at www.levil.com on the home page.
- To remove Beacon from its housing: first remove foam and LCD screen, next use a wrench to remove nuts.
- The complete Beacon manual can be downloaded at <http://aviation.levil.com/beacon-978.html>

Levil Aviation - 1704 Kennedy Point - Suite 1124 - Oviedo FL - 32765
www.levil.com - sales@levil.com - 407-542-3971

4.2 LCD INTERFACE INSTALLATION

This is the control head for the Beacon used for initial configuration and during flight as an interface for transponder functions and commands. Use the Beacon harness, or recommended wiring diagram to connect the LCD's DB9 to the cannon plug. Power will be supplied to the LCD by the Beacon. **DO NOT** connect LCD interface to 12V-24V.

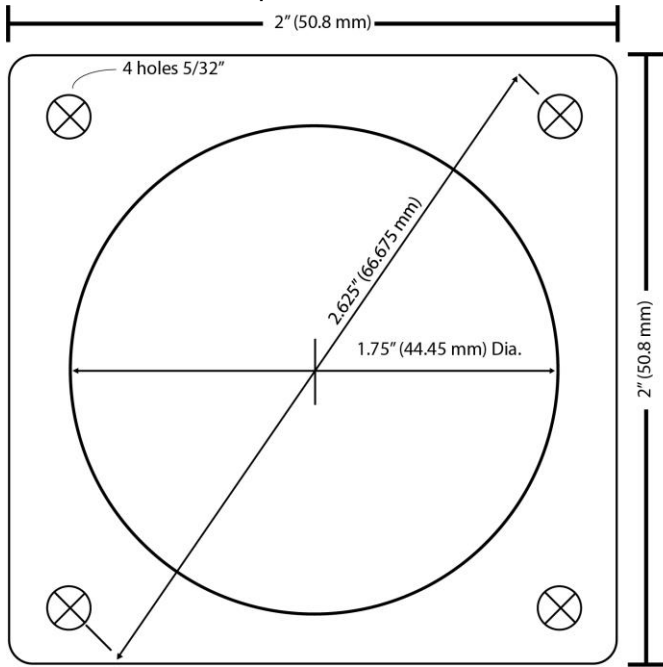

DO NOT connect LCD interface to 12V-24V.

If your aircraft is equipped with a Mode-C or Mode-S transponder, the LCD interface is not required to be in the panel. Our sniffer technology will automatically decode the transponder squawk code without you having to enter it twice. However, having the LCD available is recommended. We designed the screen as small as possible so that it fits even in the smallest panels. It is a great source of feedback regarding altitude (both pressure and GPS) and verification of correct squawk code. It is also an interface for certain commands such as "squawking anonymous" during VFR flights, and other ADS-B operations.

4.3 GPS (position source)

4.3.1 SMA connector (Beacon 978G only)

The SMA connector on the Beacon 978-s is for a GPS antenna (not included with the Beacon 978). You may use off-the-shelf active GPS antenna with a 50ohm load, which can be located remotely or inside the aircraft with as much clear view to the sky as possible. If your GPS antenna uses BCN connections, use the supplied BNC to SMA adapter. It is recommended to use the Beacon with TSOd GPS antennas.

4.3.2 External GPS receivers (Beacon 978)

When using external GPS receivers make sure they comply with the requirements for 2020. For GPS equipment, you may install an uncertified GPS on amateur-built and light-sport aircraft with experimental airworthiness certificates. However, the GPS equipment must meet the performance requirements of a GPS TSO. You can ask the equipment manufacturer, stating the device meets the performance requirements of either TSO-C166b or TSO-C154c.

Here is a list of approved GPS sources:

Levil Aviation: iLevil2 AW or iLevil3 AW (with the certified GPS option)

GARMIN: GNS 400W-530W series (with appropriate software update)

Note: If you have a specific GPS that is not listed above, contact us at info@levil.com with your suggestion.

5.0 LCD NAVIGATION

The LCD interface has one button (push and rotate) and has three different modes:

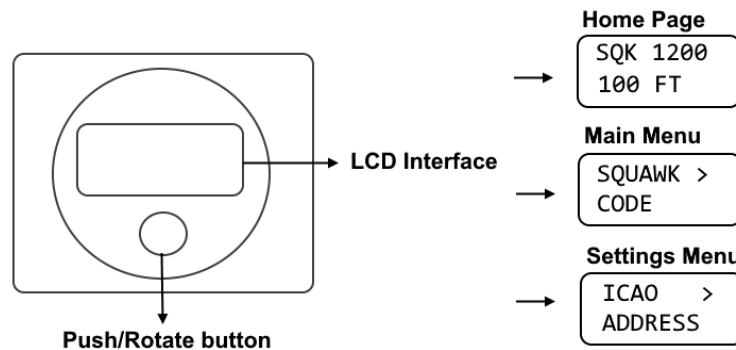

On power ON, the LCD interface will display the company name “LEVIL AVIATION”, firmware and serial number, followed by the Home Page. To navigate between the screen modes, use the button as follows:

Home Page -> PUSH and RELEASE button to enter **Main Menu**

Home Page -> PUSH and HOLD button for 4 seconds to enter **Settings Menu**

Main Menu -> Rotate the button to go through the *Menu Items*

Main Menu -> PUSH and RELEASE to enter a *Menu Items*

Main Menu -> Scroll down to “EXIT” to EXIT the **Main Menu**

Settings Menu -> Rotate the button to go through the *Menu Items*

Settings Menu -> Push and RELEASE to enter a *Menu Item*

Settings Menu -> Scroll down to “EXIT” to EXIT the **Settings Menu**

Menu Items -> Rotate the button to adjust settings, PUSH and RELEASE button to go to next character or exit

Menu Items -> PUSH and HOLD button for 2 seconds to cancel editing a setting (back to menu)

6.0 CONFIGURING YOUR BEACON

You must configure your ADS-B parameters before using the Beacon in flight. Enter the **Settings Menu** by pressing and holding the Navigation Button for 5 seconds. Then follow the instructions below for each parameter:

6.1 ICAO ADDRESS

The ICAO address is a 24-bit number issued to the aircraft by the registration authority of the aircraft. To edit the ICAO Address, rotate the button until you find the corresponding HEX value (either a capital letter A-F, or a digit number 0-1), then Push and RELEASE to go to the next field. You must enter all 6 HEX values. If you don't know your ICAO address, you can look it up using your N-number at <http://faa.gov> (N-look up is on the top right). Your ICAO Address will show under the “Mode S (base 16 hex)” field on FAA's N-look up report.

6.2 ICAO ADDRESS TYPE (“ADDRESS TYPE”)

Parameter	Description
ICAO Address	Default. Always set to ICAO for 91.227 Compliance
Temporary Address	For aircraft not assigned an ICAO (paragliders, lighter than air etc)

6.3 AIRCRAFT LENGTH (“LENGTH METERS”)

Use the two fields to enter the length of your aircraft (in meters, rounded up) from nose to tail. Size of your aircraft will be broadcasted by the Beacon when on the ground and taxing. For example:

For 4.3 meters:

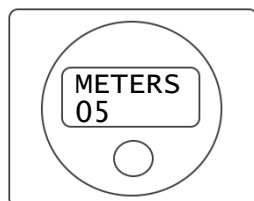

For 11.9 meters:

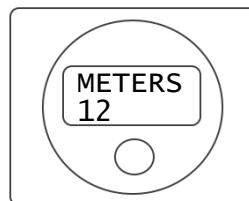

6.4 AIRCRAFT WIDTH (“WIDTH METERS”)

Enter the width (wingspan) of your aircraft (in meters). Size of your aircraft will be broadcasted by the Beacon when on the ground and taxing. Example:

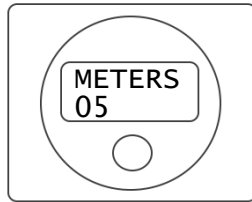

For 5 meters:

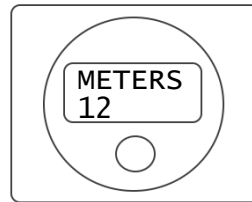

For 12 meters

6.5 ANTENNA OFFSET

If your GPS Antenna is not mounted in the exact center of the aircraft, you may enter the upper bound offset (aft from the nose, and left/right from the roll axis) so that ATC can accurately track your position for ground surveillance.

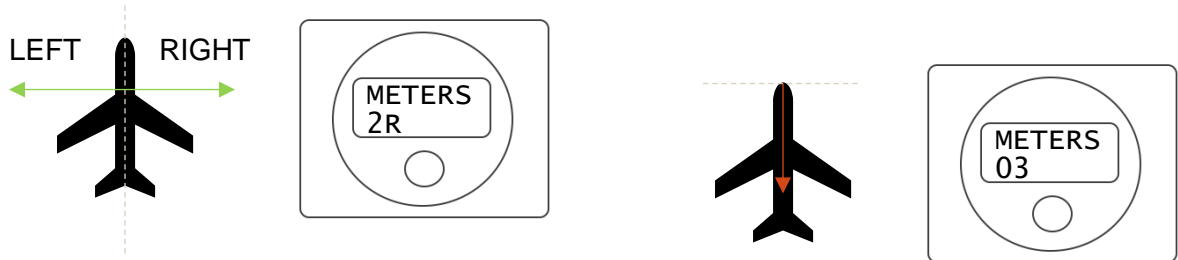

6.5.1 "ANTENNA OFFSET P"

6.5.1 "ANTENNA OFFSET R"

Upper Bound of the GPS Antenna Offset Along Lateral (Pitch) Axis, Left or Right of Longitudinal (Roll) Axis	
(meters)	Direction
0 -NO DATA (default)	LEFT
2	"L"
4	
6	
0 (no offset)	RIGHT
2	"R"
4	
6	

Upper Bound of the GPS Antenna Offset Along Longitudinal (Roll) Axis, Aft from Aircraft Nose
0 to 60 meters

6.6 CALL SIGN ("CALL SIGN")

Enter your 8 digit call sign (tail number) of your aircraft. If your call sign is less than 8 digits, leave the remainder of the items blank:

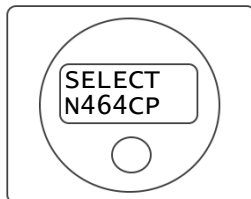

6.7 EMITTER CATEGORY (“EMITTER CATEGORY”)

Choose from the following list the category that best describes your aircraft, then enter the corresponding index on the screen:

index	Description	index	Description
01	Light airplane < 15500 lbs	10	Lighter than air
02	Small airplane <75000 lbs	11	Parachutist/skydiver
03	Large airplane <300000 lbs	12	Ultralight/hang glider/paraglider
04	High Vortex (i.e B757)	14	UAV
05	Heavy Airplane > 300000 lbs	15	Space/transatmospheric aircraft
06	High maneuverable > 5G	17	Surface Vehicle (emergency vehicle)
07	Rotorcraft	18	Surface Vehicle (service vehicle)
09	Glider/Sailplane	19	Point Obstacles (tethered balloons)

6.8 TRANSPONDER TYPE (“TRANSP. TYPE”)

Select the transponder type installed on your current aircraft, if any. Default: Mode C.

6.9 SQUAWK SYNCHRONIZATION (“SQUAWK SYNC.”)

Squawk synchronization allows your Beacon to decode the current squawk code being transmitted by your transponder (Mode C or Mode S). This way, the user does not have to input this information twice when given a new flight plan ID (squawk code) by ATC.

Synchronization Options	
NO	No sync. Squawk codes have to be manually inserted into the Beacon’s LCD interface.
SNIFFER	Beacon’s internal Sniffer decodes squawk and altitude from Mode C or Mode S transponder wirelessly
COM1	Beacon decodes squawk code and altitude from Mode C or Mode S transponders that are approved by Levil and are connected via RS-232 to COM1

6.10 CALIBRATE SNIFFER (“CALIB SNIFFER”)

If SQUAWK SYNCHRONIZATION (section 6.9) is set to “SNIFFER”, you can calibrate the signal level of the receiver portion to read your transponder code. The signal level varies from 1 to 8, 1 being the lowest amplification:

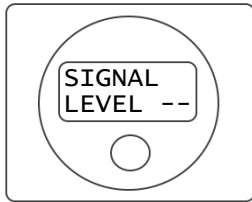

Sniffer Signal Level	
1	Minimum amplification needed (transponder signal output is strong)
2	
3	
4	Default amplification
5	
6	
7	
8	Maximum amplification needed (sniffer may have difficulty capturing transponder signal)
--	Calibration procedure could not verify a transponder squawk code of “1200”, or sniffer hasn’t been calibrated yet. See calibrating instructions below.

The calibration procedure is an autonomous function where the transponder sends a specific squawk code, the sniffer looks for this squawk code at different signal level settings. Manual adjustments of the signal level are not allowed. In order to calibrate the Sniffer, you must have:

- ✓ Corresponding transponder type selected (Mode C or Mode S)(section 6.8)
- ✓ Squawk synchronization set to “Sniffer” (section 6.9)
- ✓ Either be flying outside controlled airspace (with not active flight plan), or on the ground

1. Squawk “1200” on your transponder and activate it (no altitude)
2. Select “CALIB SNIFFER” under **Settings Menu**
3. Rotate the button to go to option “CALIB NOW”, PUSH and RELEASE button to select
4. Wait for calibration procedure to end. This process may take up to 30 seconds.
5. Finally, verify the resulted Sniffer Signal Level is NOT “- -“on your screen. If the sniffer was able to capture a 1200-squawk code correctly, the signal level will vary from 1 to 8.
6. PUSH and RELEASE to exit the calibration menu.

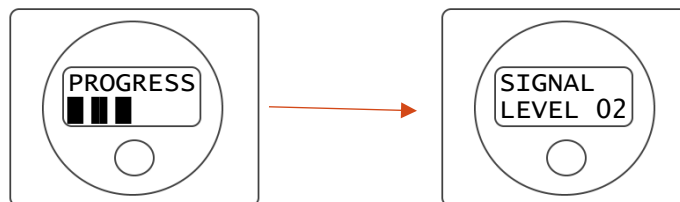

6.11 GPS SOURCE (“GPS SOURCE”)

Select the corresponding source for position. Only the devices listed below have been tested with the BEACON and are known to satisfy the position source requirements for 2020.

Model Version	Select	Description
BEACON 978-s	INTERNAL	Use internal position source.
BEACON 978	ILEVIL	Use iLevilAW with certified GPS connected on COM2 and TimeMark pins
	GARM.430	For Garmin 400W – 530W with Main software version 5.03 or later and GPS software version 5.0 or later (available from your local Garmin supplier)

6.12 CALIBRATE ALTITUDE (“CALIB ALTITUDE”)

The internal pressure sensor is calibrated from factory. You may perform an inspection/maintenance routine every 2 years. You can check the pressure altitude reported by the Beacon on the LCD interface by selecting “Pressure” under “Select Altitude” on the **Main Menu** and “SQUAWK SYNC” set to “OFF” under **Settings Menu** to prevent it from reading the transponder altitude. If calibration is needed follow the steps below:

6.12.1 LOW ALTITUDE (“CALIB LOW”)

While on the ground, set the altimeter setting on your reference altimeter (pressure based, not GPS) to standard pressure (29.92inHg or 1013 hPa). Input the altitude shown on your reference altimeter on the LCD in feet using the appropriate decimals and +/- sign:

-50 feet

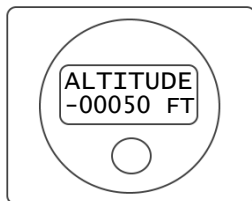

1500 feet

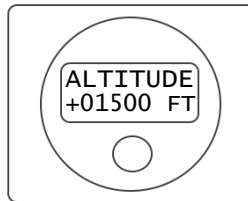

12550 feet

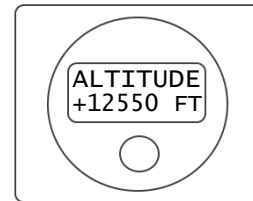

NOTE:

Verify that the LCD interface is configured to display “Pressure” under “Select Altitude” on the **Main Menu** and that “SQUAWK SYNC” is set to “OFF” under **Settings Menu**. Otherwise the LCD interface may not display pressure altitude being read by the internal pressure sensor, but a GPS or Transponder decoded altitude instead.

To verify the calibration, go back to the main screen and check the altitude.

Once the calibration procedure is done place the “SQUAWK SYNC” back to “SNIFFER” under the settings menu

6.12.1 HIGH ALTITUDE (“CALIB HIGH”)

Take the airplane to a higher altitude or use dedicated equipment on the ground to simulate a high altitude (18,000ft is ideal), set the altimeter setting on your reference altimeter (pressure based, not GPS) to standard pressure (29.92inHg or 1013 hPa). Input the altitude shown on your reference altimeter on the LCD in feet using the appropriate decimals:

9050 feet

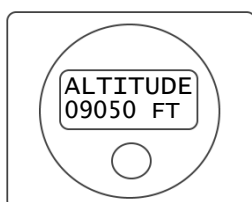

18125 feet

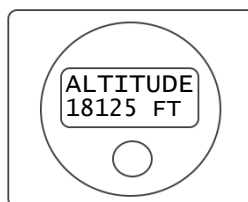

NOTE:

Verify that the LCD interface is configured to display “Pressure” under “Select Altitude” on the **Main Menu** and that “SQUAWK SYNC” is set to “OFF” under **Settings Menu**. Otherwise the LCD interface may not display pressure altitude being read by the internal pressure sensor, but a GPS or Transponder decoded altitude instead.

To verify the calibration, go back to the main screen and check the altitude.

Once the calibration procedure is done place the “SQUAWK SYNC” back to “SNIFFER” under the settings menu.

6.13 DISABLE PRESSURE ALTITUDE (“DISABLE P.ALT”)

In case of pressure altitude malfunction, due to transponder malfunction, problems on the static line, or requested by ATC, you can disable its transmission on the ADS-B output. It will automatically select GPS as the primary source of altitude. Default: No (pressure altitude not disabled)

6.14 COM1 BAUD

COM1 is not operational on firmware 16. This is for future integration of external transponders that are capable of sending the altitude through RS232.

6.15 COM2 BAUD

COM2 is used for external GPS data required on Beacon978. Select the appropriate baud rate that your external GPS is using to transmit.

6.16 Enter VSO

Enter your Stall speed with landing configurations (VSO)

6.17 EXIT

Exit Configuration Menu, goes back to Home.

8.0 HOME PAGE

8.1 NORMAL OPERATION

Displays Squawk code and altitude information. If user pressed IDENT (either on the transponder or Beacon LCD), the screen will indicate this action with "IDT"

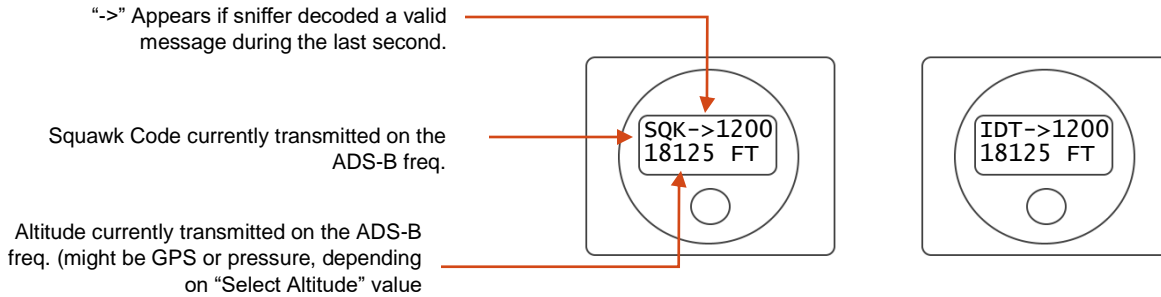

8.2 WARNINGS/MESSAGES

8.2.1 DATA ERROR

This message is displayed if there is no communication from the Beacon to the LCD display, either by total system failure (ADS-B inoperable) or harness not connected properly.

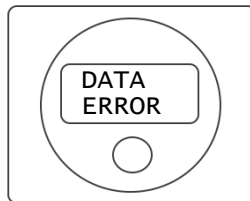

8.2.2 NO GPS

This message is displayed during initialization or when GPS does not have a valid position fix.

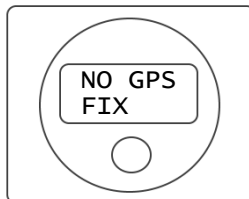

Note: This message will disappear as soon as the GPS obtains a valid position entering the **normal operations** screen

8.2.3 ICAO ERROR

This message appears when an ICAO address has not been configured properly (i.e ICAO 0x000000)

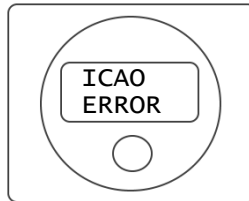

SNIFFER ERROR

When using sniffer to auto-squawk, the display will be updated every second with the decoded data from the transponder. If sniffer stops decoding data due to transponder being disabled (STB), improper calibration of sniffer or flying into none controlled airspace (no transponder interrogations from ground towers), The Beacon will warn the pilot after 40 seconds of not receiving data by flashing the three screens below. A user response is required to return to normal operation. the

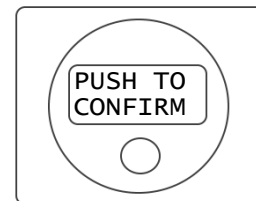
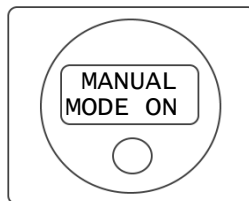
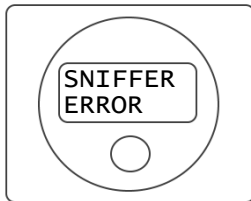

- Push the button to confirm
- After pushing "CONFIRM" the screen will show the following:

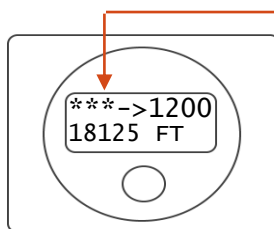

The stars "***" will appear meaning that **no valid squawk code from the transponder is being received**

Note: If a valid squawk code is not received, the Beacon will transmit the last squawk code used. THE USER MUST INPUT NEW SQUAWK CODES MANUALLY while in MANUAL MODE ON (*)**. If a valid squawk code from the transponder is received, the stars *** will change automatically displaying "SQK", the screen will go back to **normal operation (Section 8.1)** and new squawk codes are automatically synced from the transponder.

-There must be a radar for transponder interrogation for the sniffer to work

8.2.5 SQUAWK UNKNOWN

There might be cases where the decoded squawk code sent by the transponder matches a specific altitude sent by the transponder, causing a confusion as to what is altitude and what is squawk code. These cases are rare but may occur. The Beacon will send a Squawk Unknown warning and prompt the pilot to confirm the current squawk code.

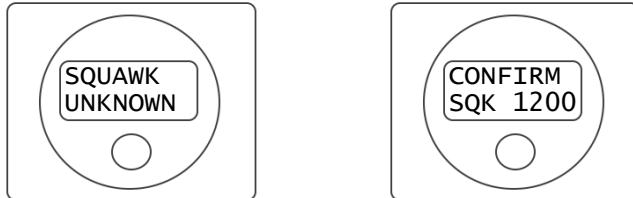

9.0 MAIN MENU

PUSH and RELEASE the button from the Home page to enter this menu. It contains basic commands and configurations that are commonly used.

9.1 SQUAWK CODE

Menu Item	Description
"Code 0000"	Allows user to enter assigned squawk code
"VFR 1200"	Assigns 1200 as squawk code
"EMGCY. 7700"	Assigns 7700 as squawk code, enables EMERGENCY status
"NO COMM 7600"	Assigns 7600 as squawk code, no Communication Emergency
"HIJACK 7500"	Assigns 7500 as squawk code, Hijack emergency

9.2 IDENT

Allows the user to IDENT when requested by ATC.

9.3 SELECT ALTITUDE SOURCE

Allows user to select primary source of Altitude that gets transmitted on the ADS-B signal. If GPS is used as default (recommended), pressure altitude will also be transmitted as secondary altitude.

9.4 SQUAWK ANONYMOUS

Only available when an active flight plan is NOT present. When squawking anonymous, the Beacon chooses a temporary ICAO address and assigns 1200 as the squawk code. If a squawk code (other than 1200) is entered (or decoded from the transponder using sniffer), anonymous is automatically canceled.

9.5 EXIT

[Exit to Home page.](#)

