

MDE Semiconductor, Inc.

78-150 Calle Tampico, Unit 210, La Quinta, CA., USA 92253 Tel: 760-564-8656 • Fax: 760-564-2414
1-800-831-4881 Email: sales@mdesemiconductor.com Web: www.mdesemiconductor.com

P4KE SERIES

GLASS PASSIVATED JUNCTION TRANSIENT VOLTAGE SUPPRESSOR VOLTAGE - 6.8 TO 550 Volts 400 Watt Peak Pulse Power

FEATURES

- Plastic package has Underwriters Laboratory Flammability Classification 94 V-O
- Glass passivated chip junction in DO-41 package
- 400W surge capability at 1ms
- Excellent clamping capability
- Low zener impedance
- Low incremental surge resistance
- Excellent clamping capability
- Fast response time: typically less than 1.0 ps from 0 volts to BV min
- Typical IR less than 1µA above 10V
- High temperature soldering guaranteed: 300°C/10 seconds/ .375", (9.5mm) lead length, 5lbs., (2.3kg) tension

MECHANICAL DATA

Case: JEDEC DO-41 Molded plastic
Terminals: Axial leads, solderable per MIL-STD-750, Method 2026
Polarity: Color band denoted positive end (cathode) except Bipolar
Mounting Position: Any
Weight: 0.012 ounces, 0.3 grams

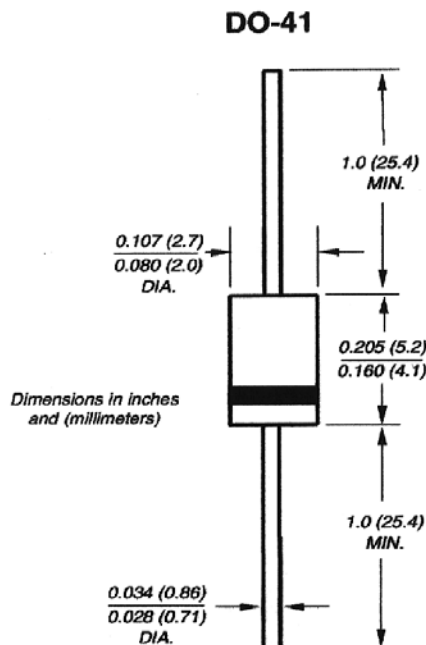

DEVICES FOR BIPOLAR APPLICATIONS

For Bidirectional use C or CA Suffix for types P4KE6.80 thru types P4KE550 (e.g. P4KE6.8C, P4KE550CA)
Electrical characteristics apply in both directions.

MAXIMUM RATINGS AND CHARACTERISTICS

Ratings at 25°C ambient temperature unless otherwise specified.

Single phase, half wave, 60Hz, resistive or inductive load.

For Capacitive load, derate current by 20%

RATING	SYMBOL	VALUE	UNITS
Peak Pulse Power Dissipation at TA = 25 °C, TP = 1ms (NOTE 1)	P _{PPM}	Minimum 400	Watts
Peak Pulse Current of on 10/1000 µs waveform (Note 1)	I _{PPM}	SEE TABLE 1	Amps
Steady State Power Dissipation at TL = 75°C Lead lengths .375", 9.5mm (Note 2)	P _{M(AV)}	1.0	Watts
Peak Forward Surge Current, 8.3ms Single Half Sine-wave Superimposed on Rated Load, (JEDEC Method)(Note 3)	I _{FSM}	40	Amps
Operating and Storage Temperature Range	T _J , T _{STG}	-55 +175	°C

NOTES:

1. Non-repetitive current pulse, per Fig.3 and derated above Ta=25 °C per Fig.2.
2. Mounted on Copper Pad area of 1.6x1.6" (40x40mm) per Fig.5.
3. 8.3ms single half sine-wave, or equivalent square wave, Duty cycle=4 pulses per minutes maximum.

Certified RoHS Compliant

UL File # E223026

MDE Semiconductor, Inc.

78-150 Calle Tampico, Unit 210, La Quinta, CA., USA 92253 Tel: 760-564-8656 • Fax: 760-564-2414
1-800-831-4881 Email: sales@mdesemiconductor.com Web: www.mdesemiconductor.com

RATING AND CHARACTERISTIC CURVES P4KE SERIES

Fig. 1 - Peak Pulse Power Rating

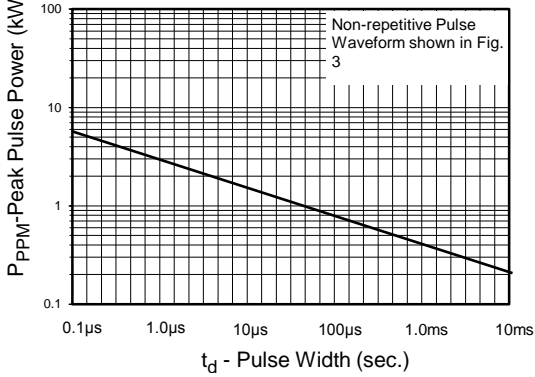

Fig.2 - Pulse Derating Curve

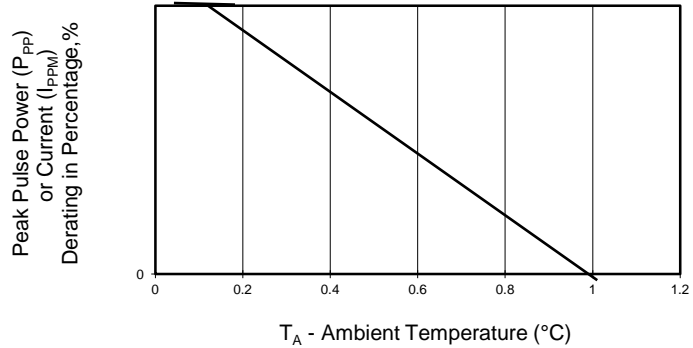

Fig.3 - Pulse Waveform

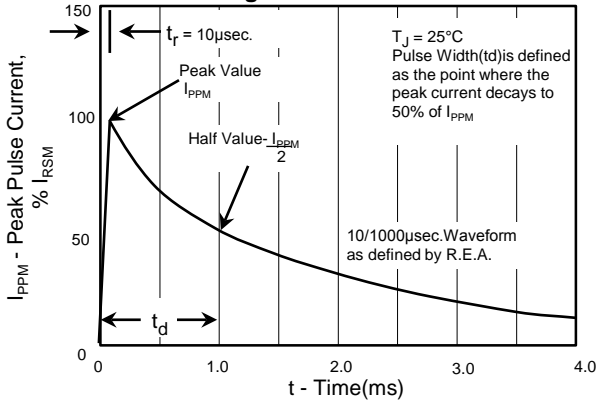

Fig.4 - Typ. Junction Capacitance Uni-Directional

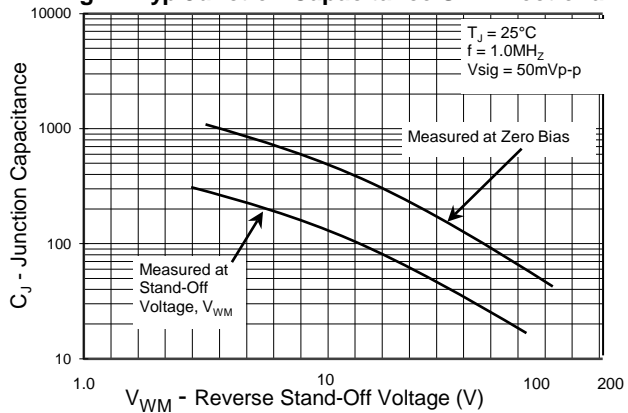

Fig.5 - steady State Power Derating Curve

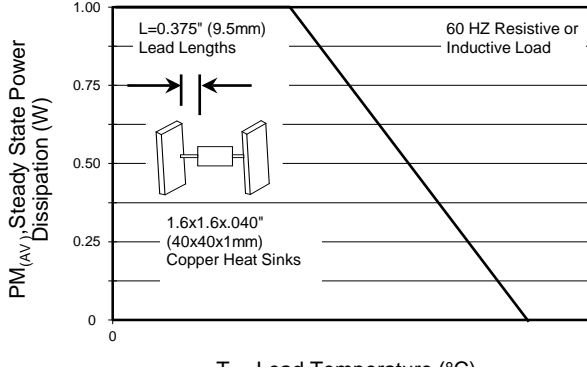

Fig.6 - Maximum Non-Repetitive Forward Surge Current Uni-Directional Only

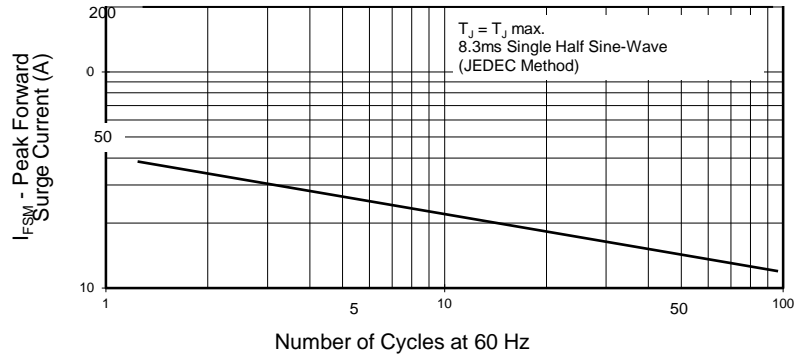

Fig.7 - Typical Reverse Leakage Characteristics

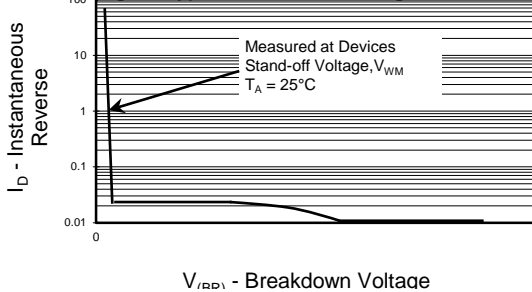
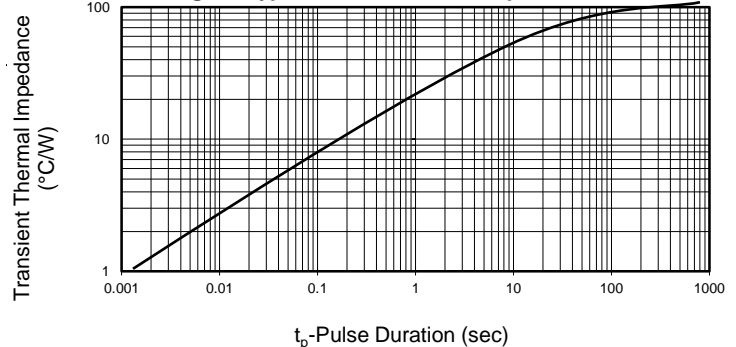

Fig. 8 - Typ. Transient Thermal Impedance



MDE Semiconductor, Inc.

78-150 Calle Tampico, Unit 210, La Quinta, CA., USA 92253 Tel: 760-564-8656 • Fax: 760-564-2414
1-800-831-4881 Email: sales@mdesemiconductor.com Web: www.mdesemiconductor.com

400 Watt TVS

UNI-POLAR	BI-POLAR	REVERSE STANDOFF VOLTAGE V_{RWM} (V)	BREAKDOWN VOLTAGE V_{BR} (V) MIN. @ I_T	BREAKDOWN VOLTAGE V_{BR} (V) MAX. @ I_T	TEST CURRENT (I_T) mA	MAXIMUM CLAMPING VOLTAGE @ I_{PP} V_C (V)	PEAK PULSE CURRENT I_{PP} (A)	REVERSE LEAKAGE @ V_{RWM} I_R (μ A)
P4KE6.8A	P4KE6.8CA	5.80	6.45	7.14	10	10.5	39.0	1000
P4KE7.5A	P4KE7.5CA	6.40	7.13	7.88	10	11.3	36.3	500
P4KE8.2A	P4KE8.2CA	7.02	7.79	8.61	10	12.1	33.9	200
P4KE9.1A	P4KE9.1CA	7.78	8.65	9.55	10	13.4	30.6	50
P4KE10A	P4KE10CA	8.55	9.50	10.50	1	14.5	28.3	10
P4KE11A	P4KE11CA	9.40	10.50	11.60	1	15.6	26.3	5
P4KE12A	P4KE12CA	10.20	11.40	12.60	1	16.7	24.6	5
P4KE13A	P4KE13CA	11.10	12.40	13.70	1	18.2	22.5	5
P4KE15A	P4KE15CA	10.00	14.30	15.80	1	21.2	19.3	5
P4KE16A	P4KE16CA	12.90	15.20	16.80	1	22.5	18.2	5
P4KE18A	P4KE18CA	14.50	17.10	18.90	1	25.2	16.1	5
P4KE20A	P4KE20CA	17.10	19.00	21.00	1	27.7	14.8	5
P4KE22A	P4KE22CA	18.80	20.90	23.10	1	30.6	13.4	5
P4KE24A	P4KE24CA	20.50	22.80	25.20	1	33.2	12.3	5
P4KE27A	P4KE27CA	23.10	25.70	28.40	1	37.5	10.9	5
P4KE30A	P4KE30CA	25.60	28.50	31.50	1	41.4	9.9	5
P4KE33A	P4KE33CA	28.20	31.40	34.70	1	45.7	9.0	5
P4KE36A	P4KE36CA	30.80	34.20	37.80	1	49.9	8.2	5
P4KE39A	P4KE39CA	33.30	37.10	41.00	1	53.9	7.6	5
P4KE43A	P4KE43CA	36.80	40.90	45.20	1	59.3	6.9	5
P4KE47A	P4KE47CA	40.20	44.70	49.40	1	64.8	6.3	5
P4KE51A	P4KE51CA	43.60	48.50	53.60	1	70.1	5.8	5
P4KE56A	P4KE56CA	47.80	53.20	58.80	1	77.0	5.3	5
P4KE62A	P4KE62CA	53.00	58.90	65.10	1	85.0	4.8	5
P4KE68A	P4KE68CA	58.10	64.60	71.40	1	92.0	4.5	5
P4KE75A	P4KE75CA	64.10	71.30	78.80	1	103.0	4.0	5
P4KE82A	P4KE82CA	70.10	77.90	86.10	1	113.0	3.6	5
P4KE91A	P4KE91CA	77.80	86.50	95.50	1	125.0	3.3	5
P4KE100A	P4KE100CA	85.50	95.00	105.00	1	137.0	3.0	5
P4KE110A	P4KE110CA	94.00	105.00	116.00	1	152.0	2.7	5
P4KE120A	P4KE120CA	102.00	114.00	126.00	1	165.0	2.5	5
P4KE130A	P4KE130CA	111.00	124.00	137.00	1	179.0	2.3	5
P4KE150A	P4KE150CA	128.00	143.00	158.00	1	207.0	2.0	5
P4KE160A	P4KE160CA	136.00	152.00	168.00	1	219.0	1.9	5
P4KE170A	P4KE170CA	145.00	162.00	179.00	1	234.0	1.8	5
P4KE180A	P4KE180CA	154.00	171.00	189.00	1	246.0	1.7	5
P4KE200A	P4KE200CA	171.00	190.00	210.00	1	274.0	1.5	5
P4KE220A	P4KE220CA	185.00	209.00	231.00	1	328.0	1.3	5
P4KE250A	P4KE250CA	214.00	237.00	263.00	1	344.0	1.2	5
P4KE300A	P4KE300CA	256.00	285.00	315.00	1	414.0	1.0	5
P4KE350A	P4KE350CA	300.00	332.00	368.00	1	482.0	0.85	5
P4KE400A	P4KE400CA	342.00	380.00	420.00	1	548.0	0.75	5
P4KE440A	P4KE440CA	376.00	418.00	462.00	1	602.0	0.68	5
P4KE480A	P4KE480CA	408.00	456.00	504.00	1	658.0	0.61	5
P4KE510A	P4KE510CA	434.00	485.00	535.00	1	698.0	0.57	5
P4KE530A	P4KE530CA	450.00	503.50	556.50	1	725.0	0.55	5
P4KE540A	P4KE540CA	459.00	513.00	567.00	1	740.0	0.54	5
P4KE550A	P4KE550CA	467.00	522.50	577.50	1	760.0	0.52	5

For bidirectional type having V_{RWM} of 10 volts and less, the I_R limit is double.

For parts without A, the V_{BR} is $\pm 10\%$

Certified RoHS Compliant

UL File # E223026

11/13/2013