



NetworX

UL approved
for ANSI/SIA
CP-01-2000

NetworX[™] Series

NX-8E Control Panel

Installation and Startup

These instructions do not purport to cover all details or variations in equipment nor to provide every possible contingency to be met during installation, operation, and maintenance. If further information is desired or if particular problems arise that are not covered sufficiently for the purchaser's purpose, the matter should be referred to GE Security, Gladewater, Texas, USA.

This document contains proprietary information of GE Security, USA and is furnished to its customer solely to assist that customer in the installation, testing, operations, and/or maintenance of the equipment described. This document shall not be reproduced in whole or in part nor shall its contents be disclosed to any third party without the written approval of GE Security.

Please refer to the current GE Security product catalog for detailed warranty information.

Main	800-727-2339	Technical Support	888-437-3287
Outside the US	903-845-6941	Sales & Literature	800-547-2556
Main Fax	903-845-6811	Web:	www.gesecurity.com

SAFETY SYMBOL LEGEND



Warning

Indicates a procedure, practice, condition, or statement that, if not strictly observed, could result in personal injury.

* This symbol indicates electrical warnings and cautions.



Caution

Indicates a procedure, practice, condition, or statement that, if not strictly observed, could result in damage to or destruction of equipment or property.

** This symbol indicates general warnings and cautions.



Note

Indicates an essential or important procedure, instruction, condition, or statement.



Tip

Indicates a user tip. Provides helpful information that is not normally defined in regular use, but from an experienced user.

Table of Contents

I.	GENERAL DESCRIPTION.....	3
II.	BOARD INSTALLATION	3
III.	GLOSSARY.....	4
IV.	PROGRAMMING THE LED KEYPADS	8
V.	PROGRAMMING THE CONTROL.....	10
	ENTERING THE PROGRAM MODE	10
	SELECTING THE MODULE TO PROGRAM.....	10
	PROGRAMMING A LOCATION.....	10
	EXITING A LOCATION	10
	EXITING THE PROGRAM MODE	10
VI.	PROGRAMMING DATA.....	12
	NUMERICAL DATA.....	12
	FEATURE SELECTION DATA.....	12
VII.	LOADING FACTORY DEFAULTS	12
VIII.	ENROLLING MODULES AND KEYPADS	12
IX.	 QUICK START INSTALLATION	12
X.	PROGRAMMING LOCATIONS.....	13
	Table X-1 COMMUNICATOR FORMAT SELECTIONS.....	13
	REPORTING EVENTS TO PHONE NUMBER 1	14
	REPORTING EVENTS TO PHONE NUMBER 2	15
	REPORTING EVENTS TO PHONE NUMBER 3	16
XI.	DEFAULT ZONE TYPES (Configurations).....	19
	Table XI-1 AUXILIARY OUTPUT EVENT SELECTION.....	25
XII.	PROGRAMMING WORKSHEETS.....	45
XIII.	NX-8E WIRING DIAGRAM.....	66
XIV.	TERMINAL DESCRIPTIONS	67
	KEYPAD MAXIMUM WIRE RUN	67
XV.	APPENDIX 1	69
	REPORTING FIXED CODES IN CONTACT ID AND SIA	
XVI.	APPENDIX 2	70
	REPORTING ZONE CODES IN SIA OR CONTACT ID	
XVII.	APPENDIX 3	71
	EXPANDER NUMBERS FOR REPORTING EXPANDER TROUBLE	
XVIII.	APPENDIX 4	72
	USER ID OR ZONE ID HEX DIGIT FOR 4+2 FORMATS	
XIX.	TELEPHONE COMPANY INTERFACE INFORMATION.....	73
XX.	NOTICES	74
XXI.	UNDERWRITERS LABORATORIES INFORMATION.....	75
XXII.	SIA SYSTEM REQUIREMENTS (ANSI / SIA CP-01)	77
XXIII.	SPECIFICATIONS	78

ORDERING INFORMATION

PART #	DESCRIPTION
NX-8E	NX-8E Control Only
NX-848E-KIT	NX-8E Control, NX-148E LCD Keypad, 16.5V 40VA Transformer
NX-108E	8 Zone LED Keypad
NX-116E	16 Zone LED Keypad
NX-124E	24 Zone LED Keypad
NX-148E	Alphanumeric LCD Keypad
NX-200 **	Zone Doubling Kit (Includes 100 3.74k and 100 6.98k resistors)
NX-216E	16 Zone Expander Module
NX-320E	Smart Power Supply and Buss Extender
NX-408E #	8 Zone Wireless Expansion Module (UL LISTED PART #60-904)
NX-416E #	16 Zone Wireless Expansion Module (UL LISTED PART #60-904)
NX-448E #	48 Zone Wireless Expansion Module (UL LISTED PART #60-904)
NX-507E	Seven Relay Module
NX-508E	Eight Output Module
NX-534E **	Two-Way Listen-In Module
NX-540 **	"Operator" Telephone Interface Module
NX-591E **	Cellemetry Interface
NX-870E	Fire Supervision Module
NX-1192E	192 Zone LCD Keypad
NX-1208E	8 Zone LED Keypad
NX-1248E	48 Zone LCD Keypad
NX-1308E	8 Zone LED Door Design Keypad
NX-1316E	16 Zone LED Door Design Keypad
NX-1324E	24 Zone LED Door Design Keypad
NX-1448E	48 Zone Fixed Language Icon Keypad
P-0003 **	RS232 Adapter Cable
8920 **	4-Wire Cable (For use on AUX 1-4)

** These products have not been tested and approved by Underwriters Laboratories, Inc.

These wireless devices are only UL listed for residential applications.

I. GENERAL DESCRIPTION

The NetworX NX-8E represents a new approach to security systems design. Drawing on our experience in the world market as the largest exporter of USA manufactured controls, we have developed the most flexible, durable, and user-friendly control ever seen in our industry. Featuring sophisticated software, which allows up to 240 users to interface with 192 zones, 8 partitions, and a host of integrated fire, access, verification, and input/output modules, all reported with the most comprehensive and fast SIA and Contact ID formats. The NetworX design allows a fully loaded system to be housed in one single metal enclosure, establishing for the first time, a logical solution and design response to modular systems. Up to 32 modules can be added to expand the capabilities of the NX-8E. For product warranty information, please refer to the GE Security Product Catalog.

II. BOARD INSTALLATION

Inside the can, several 2-holed insertion points have been constructed. This allows for either vertical or horizontal placement of the modules. Notice that each insertion point has two sizes of holes - a larger hole and a smaller hole.

Diagram 1: The black plastic PCB guides are grooved on one edge where the PC board will be seated. The end with the half-moon protrusion fits into the larger hole. The smaller hole is for the screw.

Diagram 2: Place the *first* black plastic PCB guide in the top insertion point, grooved edge downward. The half-moon protrusion will be in the large hole. It does not require force. Insert one of the provided screw into the smaller hole (from inside the can) to secure it in place. A screwdriver should reach through the notch that runs the length of the guide to tighten the screw. The *second* PBC guide should be positioned opposite the first (grooved edge up) and placed in the lower insertion point, using the same procedures described above. Once mounted, screw it in securely.

Diagram 3: The PC Board should slide freely in the grooves of both guides.

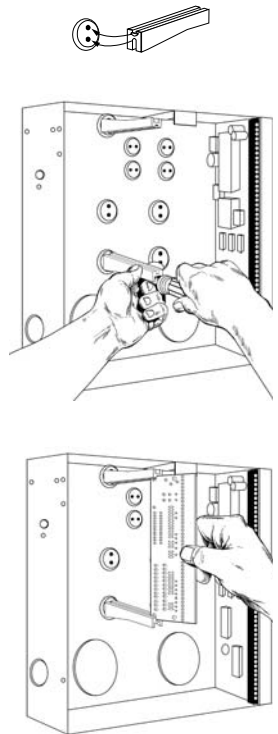

IMPORTANT!

1. If separate power supplies are necessary to accommodate additional devices, safety standards require that each power supply be prominently marked with adequate instructions for removing all power from the unit.
2. Dispose of used batteries according to the manufacturer's instructions and/or local government authorities.
3. Installation personnel should thoroughly read and understand the installation instructions and the users manuals for the panel and all the accessories to be included with the system before attempting to install a security system.



WARNING!

Replace only with Panasonic #LC12V4BP or Yuasa #NP4-12 battery. Observe polarity when installing a new battery. Installing the battery backwards may cause damage to the panel. There is a risk of explosion if the battery is replaced with an incorrect type.

NOTE

Electrical codes will vary depending upon the country and city where the system is installed. It is the installer's responsibility to ensure that the electrical installation is safe and conforms to all applicable codes, laws, or regulations. Only qualified persons should connect this device to the mains supply.

III. GLOSSARY

Abort - If enabled, the NX-8E will wait the programmed number of seconds in location 40 prior to sending an alarm. During this delay time, the "Cancel" LED will flash. To abort the report, type in a code and press the [Cancel] key. The LED will extinguish. If the report is not aborted within the allotted time, the LED will extinguish when the report is sent. "Dialer Delay" must be enabled in the "Characteristic Select" of locations 110-169. **(See locations 40 and 110-169, pages 23 and 33-37)**

AC Fail / Low Battery Report/Warning- The NX-8E can be programmed to report AC failure and/or Low Battery conditions to the central station. It can also be programmed to sound the keypad immediately upon detection of the condition. The AC failure report/warning can be delayed. **(See locations 37 and 39, page 22)**

AC Power / Low Battery Sounder Alert- If enabled, the NX-8E will beep the keypad sounder upon arming or disarming if the AC power is missing or a low battery has been detected. **(See location 23, page 18)**

Arm / Disarm Codes - The NX-8E can have 240 four-digit codes or 160 six-digit codes to arm/disarm the control. All codes must have the same number of digits. The factory default for User #1 is [1]-[2]-[3]-[4] when using a 4-digit code, or [1]-[2]-[3]-[4]-[5]-[6] for a 6-digit code. This code can then be used to enter the new arm/disarm codes. **(See location 41, page 23)**

Automatic Arming - If programmed, the NX-8E will Auto Arm at a specified time. At this time, the keypad will beep for 50 seconds before the panel arms. The arming process will be stopped if a code is entered on the keypad. The NX-8E will attempt to arm after every 45 minutes of inactivity until the next "opening" time (loc. 52), or until the system is armed. The 45-minute timer will be extended when there is activity in the building causing the "Ready" LED to turn off and on. If closing reports are sent, the user code will be 97. **(See locations 23, and 52-55, pages 18 and 26)** **NOTE: For UL installations, this feature shall be disabled.**

Auto Cancel / Abort - If enabled, the Cancel and/or Abort features will be automatic (pressing the [Cancel] button is not required). The Cancel and Abort features, in locations 23 and 40 respectively, must be enabled to permit this Auto feature to work. For proper operation of these features, "Dialer Delay" must be enabled in the "Characteristic Select" of locations 110-169 Zone Types. **(See location 41, page 23)**

Automatic Bypass / Instant Arming - When enabled, the control panel can automatically bypass interior follower zones if an exit is not detected during the exit delay time. Entry delay zones can also be made instant. **(See location 23, segments 1 and 3, page 18)**

Auto Test- This feature will cause the panel to call the central station to report a communicator test at a specified interval. **(See location 51, page 26)**

Auxiliary Outputs- The NX-8E has four programmable outputs that can be used to activate relays, LED's, etc. **(See the terminal description on page 67 and locations 45-50, pages 24-25)**

Auxiliary Power Overcurrent- The NX-8E will illuminate the "Service" LED on the keypad whenever too much current is drawn from any device powered by the system. This condition can be reported to the central station. **(See location 37, page 22)**

Box Tamper- The NX-8E has an input for a normally closed tamper switch (see terminal drawing). The Box Tamper can be programmed to report and/or sound the siren and/or the keypad. These terminals can be enabled or disabled in programming. **(See locations 37 and 39, page 22)**

Built In Siren Driver - The NX-8E has a built-in 112db-siren driver. When desired, this built-in driver can be easily converted to a 1-amp voltage output through programming. **(See location 37, page 22)**

Bypass Toggle- This feature will enable the end user to toggle (turn on or off) the bypass of an interior zone with the system armed by pressing the [Bypass] key. **(See location 23, page 18)**

Call Back- When enabled, the control will use the call back phone number to call the download computer before beginning a download. **(See location 21, page 18)**

Cancel - If enabled, the NX-8E will send a "Cancel" report if when the system is disarmed and the [Cancel] button is pressed within 5 minutes of an alarm. Once the [Cancel] key is pressed, the "Cancel" LED will illuminate until the central station acknowledges the "Cancel" report. "Dialer Delay" must be enabled in the "Characteristic Select" of locations 110-149. **(See location 23, page 18)**

Code Required Options- The NX-8E can be programmed to require a code for bypassing zones and/or initiating a download using the [*]-[9]-[8] or [*]-[9]-[9] function. **(See locations 23 and 41, pages 18 and 23)**

Communication Formats- The NX-8E can report in multiple formats. It is recommended that you use Contact ID or SIA formats if possible. If you wish to report to a pager or in a 4+2 format to a central station, you must program each code to be reported. **(See locations 56-83 and 111-169, pages 27-29 and 33-37)**

Cross Zoning - This feature requires two or more trips on a zone or zones programmed as "cross zones" within a specified time before reporting an alarm. During the time between trips, the NX-8E can be programmed to sound the keypad and/or the siren. The NX-8E can also be programmed to report an alarm after two or more trips on the same zone. **(See locations 37, 39, 40 and 110-149, pages 22, 23, 33-37)**

Dual / Split / Multiple Reports - The NX-8E can send communication reports to three different phone numbers for dual, split or multiple reports selectable by event or partition. **(See locations 4, 10, and 16, pages 14, 15, 17)**

Duress Code- If a duress code is programmed the NX-8E will send a duress signal whenever the panel is armed or disarmed with this code. If open/close reports are sent, the user code will be 254. **(See location 44, page 24)**

Dynamic Battery Test - The NX-8E can be programmed to perform a Dynamic Battery Test for a selected duration the first time the panel is armed or disarmed every day, as well as by pressing [*][4] Test Function. If the panel is not armed or disarmed during the day, it will perform the test at midnight. The NX-8E can also be programmed to perform a missing battery test every 12 seconds. **(See locations 37 and 40, pages 22 and 23)**

Early to Open / Late to Close – If an opening occurs before the opening and closing times, the NX-8E will send an "Early Open" report. If it fails to close on or before the designated closing time, the NX-8E will send a "Late to Close" report.

End of Line Resistor Defeat – The NX-8E can be programmed to make zones 1-8 for normally closed operation only, eliminating the need for the end of line resistors on these zones. When a zone is programmed for normally closed operation, a short on that zone will not change the loop condition, and an open on that zone will produce a faulted condition. This feature will be ignored by any Priority zone. **(See locations 111-169, pages 33-37) NOTE: For UL installations, all zones must be programmed as supervised.**

Entry-Guard - This unique low level arming mode has been developed to reduce the most common source of false alarms. When armed with the "Instant" LED on, the opening of any zones designated as "Entry Guard zone" will initiate the keypad sounder and start the entry delay before creating an alarm. All other zones will function as normal. This arming mode will encourage system owners to use their system more frequently when the premises are occupied. **(See locations 111-169, pages 33-37) NOTE: For UL installations, this feature shall be disabled.**

Exit Error - If enabled, the NX-8E will send an "Exit Error Report" if an entry/exit zone is faulted at the instant the exit delay expires. This report will be sent along with the user number that armed the system, if the panel is not disarmed before the entry delay expires. The alarm report will also be sent. Even if this feature is not enabled, the siren will sound if any entry/exit zone is faulted at the instant the exit delay expires. **(See location 23, page 18)**

Expander Trouble- The NX-8E will report expander trouble to the central station if enabled. This condition will illuminate the "Service" LED on the keypad even if not reported. NOTE: The keypads are considered expanders. The number of the expansion devices reported can be found on page 53. **(See location 37, page 22)**

Fail to Communicate- The NX-8E will illuminate the "Service" LED if a report fails to reach the central station. If enabled, when the next report is successfully communicated, a Fail to Communicate code will be reported. **(See location 37, page 22)**

Fire Alarm Verification - When enabled, the NX-8E will verify a Fire alarm by requiring more than one trip on a smoke detector within a specified time before creating an alarm. **(See location 40, page 23) This feature is not approved for residential use in California.**

First to Open / Last to Close - The first partition that opens from a completely armed system (all valid partitions armed) will send an "Open" report. All other partitions opened will be *log only*. The last partition to close from a completely armed system (all valid partitions armed) will report to the central station. Any prior closing(s) will be *log only*. **(Loc 37, pg 22)**

Force Arming - When enabled, the NX-8E can be Force Armed with zones violated. Under this condition, if a force armable zone is not secure, the "Ready" LED will flash. At the end of the exit delay, these zones will become bypassed. If these zones become secured any time during the arming cycle, they will be unbypassed and active in the system. If "Bypass Report" is enabled, the force arming zones can be programmed to report bypass when they are Force Armed (default), or to not report bypass even if "Bypass Report" is enabled. **(See locations 37, and 111-169, pages 22 & 33-37) NOTE: For UL installations, this feature shall be disabled.**

Ground Fault- If the NX-870E is used, a fault of the earth ground can be reported to the central station. If it is not reported, this condition will illuminate the "Service" LED on the keypad. **(See location 37, page 18)**

Group Bypass - A designated group of zones can be programmed to bypass by pressing [Bypass]-[0]-[Bypass]-[Bypass] prior to arming. (See locations 111-169, pages 33-37) **NOTE: For UL installations, this feature shall be disabled.**

Immediate Restore By Zone- The NX-8E can be programmed to send alarm and restore reports as soon as they occur, or wait until the siren time has expired. (See location 37, page 22)

Internal Event Log - Up to 512 events can be stored in memory along with the date and time of the event. These events can later be viewed through downloading. **All reportable events report to the log.**

Keypad Activated Panics- The NX-8E has three keypad activated panics that will send reports to the central station: Auxiliary 1 (Fire), Auxiliary 2 (Medical), and Keypad Panic. Auxiliary 1 will activate the steady (Fire) siren, Auxiliary 2 will sound the keypad, and the Keypad Panic can be programmed to be silent or audible (sound siren). (See location 23, page 18)

Keypad Sounder Control- The NX-8E can be programmed to sound the keypad sounder for certain events. (See location 39, page 23)

Keypad Tamper- If enabled, the NX-8E will disable the keypad for 60 seconds and communicate a tamper signal to the central station if 30 keypresses are entered without producing a valid code. (See location 23, page 18)

Keyswitch Arm/Disarm - Any zone on the NX-8E can be programmed as a keyswitch zone. If this is done, a momentary short on this zone will arm/disarm the control. If opening/closing reports are sent, the user code will be 99. (See "Default Zone Types", page 19)

LED Extinguish- This feature will extinguish all LEDs on the keypad, except the "Power" LED, after 60 seconds without a keypress. Pressing any numeric key will illuminate all LED's. (See location 23, page 18)

Local Programming Lockout- This feature will disable programming of all locations or specified locations from the keypad. (See location 21, page 18)

Log Full Report- A report can be sent to the central station when the event log is full. (See location 37, page 22)

Lost Clock Service Light- The NX-8E can be programmed to illuminate the "Service" LED when the internal clock has an invalid time due to power loss. (See location 37, page 22)

Manual Test- The NX-8E can be programmed to perform a bell and/or communicator test when [*]-[4]-[4] is entered while the system is in the disarmed state. (See location 37, page 22)

Night Mode – (Applies to NX-1208E / NX-1248E keypads) In this mode, the control panel will bypass all zones that have the Entry Guard feature enabled. (See location 23, page 18)

On Board Zone Disable- The eight zones on the NX-8E panel can be disabled in order to have a completely wireless alarm system. (See location 37, page 22)

Partitions - The NX-8E can be partitioned into a maximum of eight separate systems with distinct reporting codes, user codes, and operating features for each system. (See locations 26 - 36, pages 20-22)

Program Code - The factory default for the "Go To Program" code is [9]-[7]-[1]-[3] when using a 4-digit code or, if the 6-digit option is used, the default is [9]-[7]-[1]-[3]-[0]-[0]. The program code can also be used as an Arm/Disarm code. If used as an Arm/Disarm code, and open/close reports are sent, the user code will be 255. (See location 43, pg 24)

Quick Arm Feature - The NX-8E has a one-button "Quick Arm" feature which can be used to arm the system by pressing the [Exit] key or the [Stay] key on the keypad. If closing reports are sent, the user code will be 98. (See location 23, page 18)

Recent Closing - If enabled, the NX-8E will send a "Recent Closing Report" to the central station if an alarm occurs within 2 minutes after the panel is armed. The user number that armed the system will also be sent. (See location 23, page 18)

Re-exit - The NX-8E has the ability to restart the exit delay for a quick exit without disarming the system by pressing the [Exit] key while the system is armed. (See location 23, page 18)

Shutdown- This mode will cause the keypads to turn off all LED's, except the "Power" LED, and not accept keypresses. (See location 21, page 18)

Siren Blast For Arming- The NX-8E can be programmed to give a one-second siren blast when the panel is armed, at the end of the exit delay, or when the central station receiver acknowledges the closing report. It can also give one blast for remote (keyswitch) arming and two blasts for remote disarming. (See location 37, page 22)

Siren Supervision - The NX-8E has a "Siren Supervision" circuit that will constantly monitor the siren on the NX-8E and can be programmed to report if the wires are cut. (See location 37, page 22)

Silent Exit Option - The exit delay can be silenced by pressing [*]-[Exit] before arming the control panel or when using the re-exit feature.

Start/End Programming and End Downloading- A report can be sent when local programming is started and ended. A report can also be sent when a download session ends. **(See location 37, page 22)**

Swinger Shutdown - This feature allows a zone or zones to be automatically bypassed after a specified number of alarms. When a zone is tripped, the alarm 'counter' reflects "1" in memory. If a new (first) alarm is detected in a different zone, the counter remains at "1". If an alarm is detected on a previously tripped zone, the count increments to "2". The 'counter' will increment each time an alarm is detected on a zone with multiple trips. Bypassing will occur on the zone that causes the count to equal the number programmed in location 38; the 'counter' will reset to zero (0); and begin a new trip count where the next alarm will set the 'counter' to 1. If immediate restore is enabled in location 37, the alarms (and restores, if enabled) will be sent as they occur. If immediate restore is not enabled, a second or subsequent alarm will not be sent until the siren times out. **Factory default is 1. (See location 37 and 38, page 22)**

Telephone Line Monitor - The NX-8E has a Telephone Line Monitor that monitors the voltage and current of the telephone line for a detection of a faulted phone line. This condition can also be reported to the central station. If the report is enabled, only the Telephone Line Restore will be reported unless the NX-870E is being used. **(See locations 37, 39, and 40, pages 22-23)**

Temporal Siren Disable - If disabled, the Fire Siren will be steady and Fire Voltage Out will be the same as Burglary (continuous). Otherwise, the Fire Siren will be temporal. **(See location 37, page 22) NOTE: For UL installations, do NOT disable.**

Tone Sniff Answering Machine Defeat- If enabled, only one call is required to defeat the answering machine. To use this feature you must have a Hayes 1200 Smart Modem. From the computer, call the panel as normal. When the answering machine answers, the panel will hear the tones from the modem and seize the phone line for a download. **(See location 21, page 18)**

Two Call Answering Machine Defeat - If enabled, to defeat an answering machine, two telephone calls must be made to the premises. On the first call, let the phone ring one or two times. The control panel will detect these rings and start a 45-second timer, during which, the control panel will answer the next call on the first ring. **This is not recommended for commercial applications. (See location 21, page 18)**

Walk-Test Mode - If enabled, entering [*] [Chime] followed by a user code will allow a walk-through zone test where all zones become silent and local (non-reporting). During this test the chime light will flash on the LED keypad. Each time a zone is faulted, the zone light on the LED keypad will illuminate and the chime will sound. The number of the faulted zone(s) will be displayed on the LCD keypad. It will also be entered into alarm memory and the internal log. To exit at any time during this mode, enter a user code. Otherwise the "Walk-Test Mode" will automatically exit after 15 minutes. **(See location 41, page 23)**

Wireless Sensor Missing/Low Battery - The NX-8E will send a report to the central station when a wireless sensor has detected a low battery or has not reported to the receiver. The "Service" LED will illuminate when either condition exists. **(See location 37, page 22)**

Zone Activity Monitor – This feature will send a report to the central station when a particular zone does not change conditions within the specified number of days programmed. **(See location 40, page 23 and locations 110-169, page 33-37).**

Zone Bypassed Sounder Alert- If this feature is enabled, the NX-8E will beep the keypad sounder upon arming if a zone is bypassed. **(See location 23, page 18)**

Zone Doubling - This feature allows you to use the eight zones on the panel as sixteen normally closed zones. When this feature is used, European double E.O.L. configuration cannot be used on the first sixteen zones. **THIS FEATURE DOES NOT INCREASE THE TOTAL NUMBER OF AVAILABLE ZONES BEYOND 192.** If one of the sixteen zones must be a fire zone, it must be one of Zones 1 to 8. The corresponding upper zone will become unavailable. For example: if Zone 6 is a fire zone, then Zone 14 will not be available. **(See location 37, page 22)**

Zone Types (Configurations) - The NX-8E has 30 programmable Zone Types that determine how each zone will function and report. The default Zone Types are listed on page 18. **(See locations 111-169, pages 33-37)**

IV. PROGRAMMING THE LED KEYPADS

This section describes how to program the address and partition of each keypad as well as the options that are available. The address of the keypad is important because this is how the panel supervises the keypads.

The factory default for the Master code is [1]-[2]-[3]-[4] when using a 4-digit code or [1]-[2]-[3]-[4]-[5]-[6] for a 6-digit code. The factory default for the "Go To Program" code is [9]-[7]-[1]-[3] for a 4-digit code or [9]-[7]-[1]-[3]-[0]-[0] for a 6-digit code.

[*] [9] [2] (Applies to LED keypad ONLY)

- 1) Enter [*] [9] [2] [program code].
- 2) Enter the zone number (1 - 192) you want the keypad to start at.
- 3) Enter [*] to save and exit.

[*]-[9]-[3] Set keypad options

- 1) Enter [*]-[9]-[3] [program code]- The "Service" LED will flash.
- 2) LEDs 1-8 can now be toggled on/off to enable/disable the following functions:
- 3) After enabling/disabling the desired functions press [*]

LED	Keypad Feature Enabled
1	RESERVED. DO NOT PROGRAM THIS AT ALL!
2	Enable Silent Keypad option. Silences the entry/exit sounder & chime only.
3	Enable Ding-Dong sound for Chime - If off, chime will be a single tone. (See location 40, page 23)
4	Enable Keypress Silence option (silences the pulsing keypad sounder for 5 seconds when a key is pressed)
5	Enable Armed Status Suppression (will not allow the keypad to display faulted or bypassed zones when the system is armed)
6	Enable Panic, Fire, Medical Beeper (will sound a short beep to verify that the keypress was accepted)
7	Suppresses the "Service" LED (NOTE: For UL installations, the Service LED shall not be suppressed.) (will not allow the "Service" LED to illuminate for any reason. If there is a system trouble, pressing [*]-[2] will still show the service menu.)
8	Enable multi-partition viewing (enables temporary viewing of all partitions by pressing [*]-[1]-[partition number])

[*]-[9]-[4] Set Keypad Number and Partition

- 1) Enter [*]-[9]-[4]-[program code]- The "Service" LED and the "Instant" LED will flash.
- 2) Enter the keypad number (1-8)
- 3) Press [*]- The "Instant" LED will illuminate steady and the "Service" LED will remain flashing.
- 4) Enter the partition number for the keypad (The keypad will automatically exit this mode at this time)

[*]-[9]-[5] Set elapsed increments since last autotest

- 1) Enter [*]-[9]-[5]-[program code]-The "Service" LED will flash.
- 2) Enter [100's digit] -[10's digit]-[1's digit]-[#]

[*]-[9]-[6] Set system date

- 1) Enter [*]-[9]-[6]-[master code]. The "Service" LED will flash.
- 2) Enter [day of week (1=Sun)]-[month 10's digit]-[month 1's digit]-[day 10's digit]
[day 1's digit] -[year 10's digit]-[year 1's digit]

[*]-[9]-[7] Set system clock

- 1) Enter [*]-[9]-[7]-[master code]. The "Service" LED will flash.
- 2) Enter [hour 10's digit]-[hour 1's digit]-[minutes 10's digit]-[minutes 1's digit]

CHANGING USER CODES:

- 1) Enter [*]-[5]-[master code] - The "Ready" LED will flash.
- 2) Enter the 3 digit user number (i.e. "003 for user 3). Maximum number of users is 240.
- 3) Enter the new user code designated for that individual - The "Ready" LED will flash indicating that the code was accepted. If it rejects the code, the sounder will beep 3 times,
- 4) If another user code needs to be programmed, return to step 2.
- 5) Press [#] while the "Ready" LED is flashing to exit the User Code Programming Mode.

ASSIGNING AUTHORITY LEVEL:

- 1) Enter [*]-[6]-[master code] - The "Ready" LED will flash.
- 2) Enter [3 digit user number] (always 3 digits such as "003" for user 3) - The "Ready" LED will illuminate steady and the "Instant" LED will flash. Refer to the chart below for the description of each LED. Turn the LED on for the features that you desire.

LED	ATTRIBUTES IF LED 8 IS OFF	LED	ATTRIBUTES IF LED 8 IS ON
1	Reserved	1	Activate output #1
2	Arm Only	2	Activate output # 2
3	Arm Only After Close Window	3	Activate output # 3
4	Master arm/disarm (can program other codes)	4	Activate output # 4
5	Arm/disarm code	5	Arm/disarm
6	Allowed to bypass zones (see location 23)	6	Bypass Zones
7	Code will send open / close reports	7	Open / Close Reporting
8	If this LED is on, LEDs 1-7 will use the chart to the right	8	If this LED is off, LEDs 1-7 use the chart to the left

- 3) Enter [*] - The "Instant" LED will illuminate steady.
 This moves you to the partition enable. (This tells the system what partition this user can arm/disarm. LEDs 1-8 illuminate for each partition that the user has authorization for. To change any of these numbers, press 1-8 to permit or deny access to the user. (Example: If LED #2 is lit, then user has assigned access to that partition. By pressing the [2] key, the LED will go off indicating the user has been denied access to that partition.)
- 4) Enter [*]
 This returns you back to step 2 above. At this point you may enter another user number to assign attributes for. You may continue this procedure until you have assigned authority levels to all user numbers - or - you may press [#] key to exit the Assigning Authority Level Program.

NOTE: Any master arm/disarm code can add or change a user code if the master code has access to the same partitions as the code being added/changed. Consequently, when programming the user codes for a partitioned system, leave at least one code (can be "go to program code" if enabled in location 43) access to all partitions or you will not be able to add new users. If you desire the end user to be able to add new codes, you must remove the partition authority from all blank codes.

[*]-[9]-[8]

Pressing [*]-[9]-[8] while the system is disarmed will cause the control to do a callback for a download.
NOTE: A valid user code may be required after [*]-[9]-[8] if enabled in location 41, page 23.

[*]-[9]-[9]

Pressing [*]-[9]-[9] while the system is disarmed will cause the control panel to seize the phone line for a download. **NOTE: A valid user code may be required after [*]-[9]-[9] if enabled in location 41.**

V. PROGRAMMING THE CONTROL

ENTERING THE PROGRAM MODE

To enter the Program Mode, press [*]-[8]. At this time, the five function LEDs (Stay, Chime, Exit, Bypass, & Cancel) will begin to flash. Next, enter the "Go To Program Code" (FACTORY DEFAULT IS [9]-[7]-[1]-[3]). If the "Go To Program Code" is valid, the "Service" LED will flash and the five function LEDs will illuminate steady. You are now in the Program Mode and ready to select the module to program.

SELECTING THE MODULE TO PROGRAM

Since all modules connected to the NX-8E are programmed through the keypad, the module you are programming should be the first entry. To program the NX-8E Control Panel, enter [0]-[#]. The [0] is the module number of the control and [#] is the entry key. Other module entry numbers can be found in their corresponding manuals.

PROGRAMMING A LOCATION

Once the number of the module to be programmed has been entered, the "Armed" LED will illuminate, indicating it is waiting for a programming location to be entered. Any location can be accessed by directly entering the desired programming location followed by [#]. If the location entered is a valid location, the "Armed" LED will extinguish, the "Ready" LED will illuminate and the binary data for the first segment of this location will be shown by the zone LED's. While entering new data, the "Ready" LED will begin flashing to indicate a data change in process. The flashing will continue until the new data is stored by pressing [*]. Upon pressing [*], the keypad will advance to the next segment and display its data. This procedure is repeated until the last segment is reached. Pressing the [#] key will exit from this location, and the "Armed" LED will illuminate again waiting for a new programming location to be entered. If the desired location is the next sequential location, press the [POLICE] key. If the previous location is desired press the [FIRE] key. If the same location is desired press the [MEDIC] key. To review the data in a location, repeat the above procedure, pressing [*] without any numeric data entry. Each time [*] is pressed, the programming data of the next segment will be displayed for review.

EXITING A LOCATION

After the last segment of a location is programmed, pressing [*] will exit that location, turn the "Ready" LED off and the "Armed" LED on. The [*] must be pressed or the data will not be saved. To exit before the last segment, press [#]. As before, you are now ready to enter another programming location. If an attempt is made to program an invalid entry for a particular segment, the keypad sounder will emit a triple error beep (beep, beep, beep), and remain in that segment awaiting a valid entry.

EXITING THE PROGRAM MODE

When all the desired changes in programming have been made, it is time to exit the program mode. Pressing [Exit] will exit this programming level, and go to the "Select a Module To Program" level. If no additional modules are to be programmed, pressing [Exit] again will exit the program mode. If there is a module to be programmed, it may be selected by entering its address followed by [#] (see "Selecting the Module To Program" above). The procedure for programming these devices is the same as for the control panel, except the locations will be for the module selected.

PROGRAMMING EXAMPLE - FIGURE 1 (Numerical Data)



Zone 1 LED = 1
Zone 4 LED = 8 } Data = 9



Zone 2 LED = 2
Zone 7 LED = 64 } Data = 66

To change data in a segment, enter the data followed by [*]

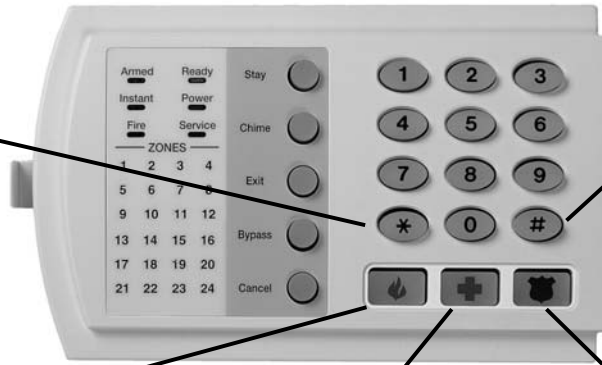

Pressing [#] will exit a location without changing the data in the current segment.

Enters the previous programming "location".

Returns to the "location" just programmed.

Advances to the next programming "location".

PROGRAMMING EXAMPLE – FIGURE 2 (Feature Selection Data)



Location 23 • Segment 1

- 1 = Quick Arm
- 2 = Re-Exit
- 3 = Auto Bypass
- 4 = Silent Keypad Panic
- 5 = Audible Keypad Panic
- 6 = Keypad Auxiliary 1
- 7 = Keypad Auxiliary 2
- 8 = Multi-Keypad Tamper

Press the key on the numeric keypad that corresponds to the feature you wish to enable/disable. When an LED is "on", a feature is enabled; when "off" the feature is disabled. For example: With the 1, 5, & 7 LEDs "on", Quick Arm, Audible Keypad Panic and Keypad Auxiliary 2 are enabled.

VI. PROGRAMMING DATA

Programming data is always one of two types. One type of data is numerical and can take on values from 0 to 15 or 0 to 255 depending on the location's segment. The other type of data is a feature selection type. Feature selection data is used to turn features on or off. Use the following procedures when working with these two data types:

NUMERICAL DATA

Numerical data is programmed by entering a number from 0-255 on the numeric keys of the system keypad. To view the data in a location, a binary process is used. With this process, the LEDs for zones 1 through 8 are utilized, and the numeric equivalents of their illuminated LEDs are added together to determine the data in a programming location.

The numeric equivalents of these LEDs are as follows:

Zone 1 LED = 1	Zone 2 LED = 2	Zone 3 LED = 4	Zone 4 LED = 8
Zone 5 LED = 16	Zone 6 LED = 32	Zone 7 LED = 64	Zone 8 LED = 128

Example: If the numerical data to be programmed in a location is "66", press [6]-[6] on the keypad. The LEDs for Zone 2 and Zone 7 will become illuminated indicating 66 is in that location (2 + 64 = 66). See this example on page 11. Once the data is programmed, press [*] to enter the data and advance to the next segment of that location. After the last segment of a location is programmed, press [*] to exit that location, turn the "Ready" LED off and the "Armed" LED on. As before, you are now ready to enter another programming location. If an attempt is made to program a number too large for a particular segment, the keypad sounder will emit a triple beep, indicating an error, and remain in that segment awaiting a valid entry. On the LCD keypad, the number in the location will be displayed. For locations with a maximum of 15, the hexadecimal equivalent will be displayed in parenthesis. Example: 11 (B) or 14 (E).

FEATURE SELECTION DATA

Feature selection data will display the current condition (on or off) of eight features associated with the programming location and segment selected. Pressing a button on the touchpad (1 thru 8) that corresponds to the "feature number" within a segment will toggle (on/off) that feature. Pressing any numeric key between [1] and [8] for selection of a feature, will make the corresponding LED illuminate (feature ON). Press the number again, and the LED will extinguish (feature OFF). You will see that numerous features can be selected from within one segment. For instance, if all eight features of a segment are desired, pressing [1]-[2]-[3]-[4]-[5]-[6]-[7]-[8] will turn on LED's 1 thru 8 as you press the keys, indicating that those features are enabled. **LCD Keypad Users Note: The numbers of the enabled features will be displayed. However, the features not enabled will display a hyphen (-).** After the desired setting of features is selected for this segment, press [*]. This will enter the data and automatically advance to the next segment of the location. When you are in the last segment of a location and press [*] to enter the data, you will exit that location. This will now turn the "Ready" LED off and the "Armed" LED on. As before, you are now ready to enter another programming location.

VII. LOADING FACTORY DEFAULTS

To load the factory defaults, enter the program mode using the procedure on page 9, then type [9]-[1]-[0]-[#]. The keypad will beep 3 times indicating that the loading is in progress. The loading takes about 6 seconds.

VIII. ENROLLING MODULES AND KEYPADS

For supervision purposes, the NX-8E has the ability to automatically find and store in its memory, the presence of all keypads, zone expanders, wireless receivers, and any other module connected to the data terminal. This allows these modules to be supervised by the control panel. To enroll the modules, enter the Program Mode of the NX-8E control panel as described on page 9. When the Program Mode is exited, the NX-8E control will automatically enroll the devices. The enrolling process takes about 12 seconds, during which time the "Service" LED will illuminate. User codes will not be accepted during the enrolling process. If a speaker is attached to the NX-8E, it will click at this time. If a siren or bell is attached to the NX-8E, it will sound for about 1 second. Once a module is enrolled, if it is not detected by the control, the "Service" LED will illuminate.

IX. QUICK START INSTALLATION

For most routine installations, the "Quick Start" option will allow for enabling a majority of the options available with the NX-8E, when communicating in Contact ID or SIA formats and without partitioning. The "Quick Start" locations can be identified by the  symbol.

X. PROGRAMMING LOCATIONS

LOCATION 0 – PROGRAMMING PHONE NUMBER #1 (20 segments, numerical data)

The first telephone number is programmed in location 0. A "14" indicates the end of the phone number. Delays of four seconds can be programmed at any point in the phone number by programming a "13" in the appropriate segment. If tone dialing is desired, program a "15" in the segment where tone dialing should begin. If the entire number should be tone dialing, program a "15" in the first segment. Program an "11" for a "*", and a "12" for a "#". **Caution:** A call-waiting cancel on a non-call waiting line will prevent successful connection to the central station.

LOCATION 1 - ACCOUNT CODE FOR THE PHONE #1 (6 segments, numerical data)

The account code sent when Phone #1 is dialed is programmed in location 1. Program a "10" in the segment immediately after the last digit of the account code. If the account code is 6 digits long, program all 6 segments.

LOCATION 2 - COMMUNICATOR FORMAT FOR PHONE #1 (1 segment, numerical data)

Location 2 contains the communicator format used to transmit to the receiver connected to Phone #1. Consult the instructions for your central station receiver to determine which format is compatible. Select a format from Table X-1 COMMUNICATOR FORMAT SELECTIONS. If you require a format other than those listed, review the override options described in location 18, to build the appropriate format. A "15" must be programmed in location 2 in addition to the entries in location 18 in order to create a special format. If this location contains a "0", the built-in communicator will be disabled, and the NX-8E will function as a local only control.

Table X-1 COMMUNICATOR FORMAT SELECTIONS

DATA	FORMAT	DESCRIPTION
0	Local	Communicator is disabled
1	Universal 4+2	Two digit event code 1800hz transmit 2300hz handshake double round parity 40pps
2	3+1 fast (or 4+1)	One digit event code 1900Hz transmit 1400Hz handshake double round parity 20pps
3	Reserved	Reserved
4	Pager	2 digit event code DTMF transmission
5	3/1 or 4/1 slow	1800hz transmit 2300hz handshake double round parity 20 p.p.s. hex capability
6	3/1 or 4/1 slow	1800hz transmit 1400hz handshake double round parity 20 p.p.s. hex capability
7	3/1 or 4/1 fast	1800hz transmit 2300hz handshake double round parity 40 p.p.s. hex capability
8	3/1 or 4/1 fast	1800hz transmit 1400hz handshake double round parity 40 p.p.s. hex capability
9	3/1 or 4/1 fast with parity	1800hz transmit 2300hz handshake single round w/parity 40 p.p.s. hex capability
10	3/1 or 4/1 fast with parity	1800hz transmit 1400hz handshake single round w/parity 40 p.p.s. hex capability
11	4+2 express	2 digit event code DTMF transmission
12	4+2 fast	Two-digit event code 1900hz transmit 1400hz handshake double round parity 20 p.p.s.
13	Ademco Contact ID	DTMF (see pages 69 & 70)
14	SIA	FSK (see pages 69 & 70)
15	Custom format	(See location 18, page 17)

LOCATION 3 - DIAL ATTEMPTS/BACKUP CONTROL FOR PHONE # 1 (2 segments, numerical data)

Segment 1- Dial attempts: Location 3, Segment 1 is used to enter the number of dial attempts (1 to 15 Attempts) the communicator will make to Phone #1 before ending the notification process. Factory default is "8" and the communicator will make eight (8) attempts to the first number.

Segment 2- Phone #1 Backup Control: Programming a "0" in Segment 2 of this location will cause the NX-8E to make the designated number of attempts to Phone #2 before setting the "Fail To Communicate" condition and stop

reporting. Programming a "1" in this segment will cause the NX-8E to stop trying to communicate after the designated number of attempts have been made to Phone #1. If a "2" is programmed in this segment, it will cause the NX-8E to make the dial attempts in increments of two. The first two attempts will be made to Phone #1, the next two attempts to Phone #2, then repeating until the total number of attempts designated in Segment 1 is completed.

REPORTING EVENTS TO PHONE NUMBER 1

Phone #1 has two programming locations that are used to select which events are reported to this phone number. Location 4 is used to select which events are reported to Phone #1. Location 5 is used to select which partitions are reported to Phone #1. If dual or split reporting is not desired, location 4 should be used to select all events to Phone #1 and location 5 should be left at the factory default of "0". If dual or split reporting is desired, and the split is based on the event type (such as alarm, open/close, etc.), location 4 should be used to select only those events that should be reported to Phone #1 and location 5 should be left at the factory default of "0". If dual or split reporting is desired, and the split is based on partition, location 4 should be programmed as a "0" and location 5 should be used to select those partitions that should be reported to Phone #1. If no events should be reported to Phone #1, both locations should be programmed as "0" (disabling all options).

LOCATION 4 - EVENTS REPORTED TO PHONE # 1 (2 segments, feature selection data)

Segment 1:

- 1 = Alarms and Alarm Restores.
- 2 = Opening and Closings.
- 3 = Zone Bypass and Bypass Restores.
- 4 = Zone Trouble and Trouble Restores.
- 5 = Power Fail, Low Battery, Power Restore, and Low Battery Restore.
- 6 = Bell Cut, Telephone Line Cut, Bell Cut Restore, Telephone Line Restore.
- 7 = Test Reports.
- 8 = Start and End programming, Download complete.

Segment 2:

- 1 = Zone and Box Tamper and Tamper Restore.
- 2 = Auxiliary Power Overcurrent, Ground Fault, and Restore for both.
- 3 = Wireless Sensor Missing and Restore.
- 4 = Wireless Sensor Low Battery and Restore.
- 5 = Expander Trouble and Restore.
- 6 = Fail To Communicate.
- 7 = Zone Activity Monitor.
- 8 = Reserved.

LOCATION 5 - PARTITIONS REPORTED TO PHONE #1 (1 segment, feature selection data)

Location 5 is used when events to be reported to a phone number are based upon the partition regardless of the event. If this location is used, location 4 should be programmed as "0".

Segment 1:

- 1 = Partition #1
- 2 = Partition #2
- 3 = Partition #3
- 4 = Partition #4
- 5 = Partition #5
- 6 = Partition #6
- 7 = Partition #7
- 8 = Partition #8

LOCATION 6 - PROGRAMMING PHONE #2 (20 segments, numerical data)

Phone #2 is programmed in location 6. A "14" indicates the end of the phone number. Delays of four seconds can be programmed at any point in the phone number by programming a "13" in the appropriate segment. If tone dialing is desired, program a "15" in the segment where tone dialing should begin. If the entire number should be tone dialing, program a "15" in the first segment. Program an "11" for a "*", and a "12" for a "#". **Caution:** A call-waiting cancel on a non-call waiting line will prevent successful connection to the central station.

LOCATION 7 - ACCOUNT CODE FOR THE PHONE #2 (6 segments of numerical data)

The account code sent when Phone #2 is dialed is programmed in location 7. Program a "10" in the segment immediately after the last digit of the account code. If the account code is 6 digits long, program all 6 segments. If this location is left unprogrammed, account code 1 will be used when the second phone number is dialed.

LOCATION 8 - COMMUNICATOR FORMAT FOR PHONE # 2 (1 segment, numerical data)

Location 8 contains the communicator format used to transmit to the receiver connected to Phone #2. Consult the instruction manual for your central station receiver to determine which format is compatible, and select from Table X-1 COMMUNICATOR FORMAT SELECTIONS on page 13. If you require a format other than those listed, review the override options described in Location 18 to build the appropriate format. A "15" must be programmed in location 8 in addition to the entries in location 18 in order to create a special format. If this location contains a "0", format 1 will be used when Phone #2 is dialed.

LOCATION 9 - DIAL ATTEMPTS/BACKUP CONTROL FOR PHONE #2 (2 segments, numerical data)

Segment 1, Dial attempts: Segment 1 of Location 9 is used to enter the number of dial attempts (1 to 15 attempts) the communicator will make to Phone #2 before ending the notification process. Factory default is "8" and the communicator will make the same number of attempts as those programmed in location 3.

Segment 2, Phone #2 Backup Control: Programming a "0" in Segment 2 of this location will cause the NX-8E to make the designated number of attempts to Phone #1 before setting the "Fail To Communicate" condition and stop reporting. Programming a "1" in this segment will cause the NX-8E to stop trying to communicate after the designated number of attempts have been made to Phone #2. If a "2" is programmed in this segment, it will cause the NX-8E to make the dial attempts in increments of two. The first two attempts will be made to Phone #2, the next two attempts to Phone #1, then repeating until the total number of attempts designated in Segment 1 is completed.

REPORTING EVENTS TO PHONE NUMBER 2

Phone #2 can be used to back up Phone #1 or for a second receiver to multi-report or split report events. Phone #2 has two programming locations that are used to select which events are reported to this phone number. Location 10 is used to select which events are reported to Phone #2, and location 11 is used to select which partitions are reported to Phone #2. If dual or split reporting is not desired, location 10 and location 11 should be left at the factory default of "0". If multi-reporting or split reporting is desired, and the split is based on the event type (such as alarm, open close etc.), location 10 should be used to select only those events that should be reported to Phone #2, and location 11 should be left at the factory default of "0". If dual or split reporting is desired, and the split is based on partition, then location 10 should be programmed as "0", and location 11 should be used to select those partitions that should be reported to the Phone #2. If no events should be reported to Phone #2, both locations should be "0".

LOCATION 10 - EVENTS REPORTED TO PHONE #2 (2 segments of feature selection data)

Segment 1:

- 1 = Alarms and Alarm Restores.
- 2 = Opening and Closings.
- 3 = Zone Bypass and Bypass Restores.
- 4 = Zone Trouble and Trouble Restores.
- 5 = Power Fail, Low Battery, Power Restore, and Low Battery Restore.
- 6 = Bell Cut, Telephone Line Cut, Bell Cut Restore, Telephone Line Restore.
- 7 = Test Reports.
- 8 = Start and End programming, Download complete.

Segment 2:

- 1 = Zone and Box Tamper and Tamper Restore.
- 2 = Auxiliary Power Overcurrent and Ground Fault and Restore for both.
- 3 = Sensor Missing and Restore.
- 4 = Sensor Low Battery and Restore.
- 5 = Expander Trouble and Restore.
- 6 = Fail To Communicate.
- 7 = Zone Activity Monitor.
- 8 = Reserved.

LOCATION 11 - PARTITIONS REPORTED TO PHONE #2 (1 segment, feature selection data)

Location 11 is used when events to be reported to a phone number are based upon the partition regardless of the event. If this location is used, location 10 should be "0".

Segment 1:

1 = Partition #1	3 = Partition #3	5 = Partition #5	7 = Partition #7
2 = Partition #2	4 = Partition #4	6 = Partition #6	8 = Partition #8

LOCATION 12 - PROGRAMMING PHONE #3 (20 segments, numerical data)

Phone #3 is programmed in location 12. A "14" indicates the end of the phone number. Delays of four seconds can be programmed at any point in the phone number by programming a "13" in the appropriate segment. If tone dialing is desired, program a "15" in the segment where tone dialing should begin. If the entire number should be tone dialing, program a "15" in the first segment. Program an "11" for a "*", and a "12" for a "#". **Caution:** A call-waiting cancel on a non-call waiting line will prevent successful connection to the central station.

LOCATION 13 - ACCOUNT CODE FOR PHONE #3 (6 segments, numerical data)

The account code sent when Phone #3 is dialed is programmed in location 13. Program a "10" in the segment immediately after the last digit of the account code. If the account code is 6 digits long, program all 6 segments. If location 6 is left unprogrammed, account code 1 will be used when the Phone #3 is dialed.

LOCATION 14 - COMMUNICATOR FORMAT FOR PHONE #3 (1 segment, numerical data)

Location 14 contains the communicator format used to transmit to the receiver connected to phone #3. Consult the instruction manual for your central station receiver to determine which format is compatible, and select from Table X-1 COMMUNICATOR FORMAT SELECTIONS on page 13. If you require a format other than those listed, review the override options described in Location 18 to build the appropriate format. A "15" must be programmed in location 14 in addition to the entries in location 18 in order to create a special format. If this location contains a "0", format 1 will be used when Phone #3 is dialed.

LOCATION 15 - DIAL ATTEMPTS/BACKUP CONTROL FOR PHONE #3 (2 segments, numerical data)

Segment 1, Dial Attempts: Segment 1 of Location 15 is used to enter the number of dial attempts (1 to 15 attempts) the communicator will try to Phone #3 before ending the notification process. Factory default is "8" and the communicator will make the same number of attempts as those programmed in location 3.

Segment 2, Phone #3 Backup Control: Programming a "0" in Segment 2 of this location will cause the NX-8E to make the designated number of attempts to Phone #2 before setting the "Fail To Communicate" condition and stop reporting. Programming a "1" in this segment will cause the NX-8E to stop trying to communicate after the designated number of attempts have been made to Phone #3. If a "2" is programmed in this segment, it will cause the NX-8E to make the dial attempts in increments of two. The first two attempts will be made to Phone #3, the next two attempts to Phone #2, then repeating until the total number of attempts designated in Segment 1 is completed.

REPORTING EVENTS TO PHONE NUMBER 3

Phone #3 can be used for a third receiver to multi-report or split report events. Phone #3 has two programming locations that are used to select which events are reported to this phone number. Location 16 is used to select which events are reported to Phone #3, and Location 17 is used to select which partitions are reported to Phone #3. If dual or split reporting is not desired, location 16 and location 17 should be left at the factory default of "0". If multi-reporting or split reporting is desired and the split is based on the event type (such as alarm, open/close, etc.), then location 16 should be used to select only those events that should be reported to Phone #3 and location 17 should be left at the factory default of "0". If dual or split reporting is desired, and the split is based on partition, then location 16 should be programmed to "0" and location 17 should be used to select those partitions that should be reported to Phone #3. If no events should be reported to Phone #3, both locations should be "0".

LOCATION 16 - EVENTS REPORTED TO PHONE #3 (2 segments, feature selection data)

Segment 1: 1 = Alarms and Alarm Restores.
2 = Opening and Closings.
3 = Zone Bypass and Bypass Restores.
4 = Zone Trouble and Trouble Restores.
5 = Power Fail, Low Battery, Power Restore, and Low Battery Restore.
6 = Bell Cut, Telephone Line Cut, Bell Cut Restore, Telephone Line Restore.
7 = Test Reports.
8 = Start and End programming, Download complete.

Segment 2: 1 = Zone and Box Tamper and Tamper Restore.
2 = Auxiliary Power Overcurrent and Ground Fault and Restore for both.
3 = Sensor Missing and Restore.
4 = Sensor Low Battery and Restore.
5 = Expander Trouble and Restore.
6 = Fail To Communicate.
7 = Zone Activity Monitor.
8 = Reserved.

LOCATION 17 - PARTITIONS REPORTED TO PHONE #3 (1 segment, feature selection data)

Location 17 is used when events to be reported to a phone number are based upon the partition regardless of the event. If this location is used, location 16 should be "0".

Segment 1: 1 = Partition #1
2 = Partition #2
3 = Partition #3
4 = Partition #4
5 = Partition #5
6 = Partition #6
7 = Partition #7
8 = Partition #8

LOCATION 18 - CUSTOM COMMUNICATOR FORMAT (See locations 2, 8, &14)

Segment 1: 1 = On for 1800hz transmit; Off for 1900hz.
2= On for 2300hz handshake; Off for 1400hz.
3= On for cksum parity; Off for double round parity.
4= On for 2 digit event code; Off for 1 digit event code.
5= Reserved.
6= Reserved.
7= On for 20 p.p.s.; Off for 10 or 40 p.p.s.
8= On for 10 p.p.s.; Off for 20 or 40 p.p.s.

Segment 2: 1= On for pager format (no handshake required).
2= On for 1400/2300 handshake.
3= Reserved
4= Reserved.
5= On for Contact ID.
6= On for SIA.
7= On for Contact ID or 4+3.
8= On for DTMF.

Segment 3 & 4: Reserved.

 **LOCATION 19 - DOWNLOAD ACCESS CODE (8 segments, numerical data)**

Location 19 contains the eight-digit access code the NX-8E must receive from the downloading software before the panel will permit downloading to occur. The factory default code is 84800000.

 **LOCATION 20 - NUMBER OF RINGS TO ANSWER (1 segment, numerical data)**

Location 20 contains the number of rings to answer for a download. Enter a number from "0" (disabled) to "15". Factory default is "8" and the NX-8E will answer on 8 rings.

LOCATION 21 - DOWNLOAD CONTROL (1 segment, feature selection data)

Location 21 contains the feature selections for the controlling of download sessions. The following features can be enabled or disabled using this location. (See the feature definitions beginning on page 4)

Segment 1:

- 1 - On enables two call answering machine defeat.
- 2 - On enables tone sniff answering machine defeat.
- 3 - On requires call back before download session.
- 4 - Shutdown (**can only be viewed from the keypad, must be changed through downloading**).
- 5 - On locks all local programming. (**can only be viewed from the keypad, must be changed through downloading**)
- 6 - On locks programming of all locations associated with the communicator (**can only be viewed from the keypad, must be changed through downloading**)
- 7 - On locks out download section. (**can only be viewed from the keypad, must be changed through downloading. If "On", locations 19 - 22 cannot be viewed from the keypad; can only be viewed from the keypad when "Off".**)
- 8 - On enables call back at auto test interval.

LOCATION 22 - DOWNLOAD CALL BACK NUMBER (20 segments, numerical data)

If a telephone number is programmed into this location, and "Require Callback" is enabled in location 21, the control panel will hang up for approximately 36 seconds (ensuring that the calling party has disconnected), and then call back. If tone dialing is desired, program an "15" in the segment where tone dialing should begin. If the entire number should be tone dialing, program an "15" in the first segment. Four-second delays can be obtained anywhere in the sequence by programming a "13" in the appropriate delay location. **WARNING: THE CALLBACK PHONE NUMBER SHOULD ALWAYS BE REVIEWED FOR ACCURACY BEFORE DISCONNECTING.**

LOCATION 23 - PARTITION 1, FEATURE AND REPORT SELECTIONS (5 segments, feature selection data)

Location 23 is used to enable certain features that can be accessed or are visible to the user from the keypad of the system. In addition, certain communicator reports are enabled in location 23. Each of these features can be enabled by partition. For additional partition information see locations 88-109 on pages 30-32. **If the feature selection location for any partition is left blank, that partition will use this location for the feature selection.**

This location contains 3 segments of 8 features each. (See the feature definitions beginning on page 4.)

- Segment 1:**
- 1 - On enables the Quick Arm feature.
 - 2 - On enables the Re-exit feature.
 - 3 - On enables the Automatic Bypass feature.
 - 4 - On enables the Silent Keypad Panic feature (**overrides the audible panic selection**).
 - 5 - On enables the Audible Keypad Panic feature.
 - 6 - On enables the Keypad Aux 1 feature (FIRE).
 - 7 - On enables the Keypad Aux 2 feature (MEDICAL).
 - 8 - On enables the Keypad Multiple Code Attempt Tamper feature.

- Segment 2:**
- 1 - On enables the LED Extinguish feature.
 - 2 - On enables the Require Code for Bypassing feature.
 - 3 - On enables the Zone Bypassed Sounder Alert feature.
 - 4 - On enables the AC Power/Low Battery Sounder Alert feature.
 - 5 - On enables Bypass toggle.
 - 6 - On enables Silent Auto Arm.
 - 7 - On enables the Automatic Instant feature.
 - 8 - On enables Instant mode. (Applies to NX1208E / NX1248E)

- Segment 3:**
- 1 - On enables Opening and Closing reports.
 - 2 - On enables Zone Bypass reporting.
 - 3 - On enables Zone Restore reporting.
 - 4 - On enables Zone Trouble reporting.
 - 5 - On enables Zone Tamper reporting.
 - 6 - On enables the Cancel reporting.
 - 7 - On enables the Recent Closing report.
 - 8 - On enables the Exit Error report.

Segment 4: 1 – On enables Late to Close / Early to Open.
 2 – On enables Auto Arm in Stay Mode.
 3 – On disables the door delays in Night mode. (Applies to NX-1208E / NX-1248E)
 4 - 8 Reserved.

Segment 5: Reserved

 **LOCATION 24 - ENTRY / EXIT TIMERS (6 segments, numerical data)**
 Location 24 is used to program the Entry/Exit times. There are 2 separate Entry/Exit times.

Segment 1, Entry time 1: This is the entry time that will be used when a delay 1 zone type initiates an entry delay. Valid entries are 30-255 seconds.
Segment 2, Exit time 1: This is the exit time that will be used for all zones designated as delay 1. Valid entries are 45-255 seconds.
Segment 3, Entry time 2: This is the entry time that will be used when a delay 2 zone type initiates an entry delay. Valid entries are 30-255 seconds.
Segment 4, Exit time 2: This is the exit time that will be used for all zones designated as delay 2. Valid entries are 45-255 seconds.
Segments 5 & 6 Reserved.

XI. DEFAULT ZONE TYPES (Configurations)

Zones can be programmed to be one of thirty different zone types (configurations). Zone types # 17 - 20 can be used for wireless or hardwired zones using European double EOL configuration. The default zone types are listed below. These zone types can be customized by programming locations 110-169.

DATA	DESCRIPTION OF DEFAULT ZONE TYPES
1	DAY ZONE - Instant when system is armed trouble zone when system is disarmed.
2	24-HOUR AUDIBLE - Creates an instant yelping siren alarm regardless of the armed state of the control panel.
3	ENTRY/EXIT DELAY 1- A trip will start entry delay 1. The lack of a trip during exit delay will enable the Automatic Bypass or Instant mode if so programmed.
4	FOLLOWER WITH AUTO- BYPASS DISABLED - This zone will be instant when the system is armed and no entry or exit delays are being timed. It is delayed during entry and exit delay 1 times. This zone will not automatically bypass even if enabled in Segment 1 of Location 23.
5	INTERIOR FOLLOWER WITH AUTO- BYPASS ENABLED - This zone will be instant when the system is armed and no entry or exit delay is being timed. It is delayed during entry and exit delay 1 times. This zone will automatically bypass if enabled in Segment 1 of Location 23.
6	INSTANT - This zone creates an instant alarm whenever it is tripped and the Armed LED is on.
7	24-HOUR SILENT - Creates an instant silent alarm regardless of the armed state of the control panel. It will not display on the keypad.
8	FIRE - This zone will light the Fire LED and sound the temporal siren each time the zone is shorted. It will also rapidly flash the Fire LED indicating a trouble if the zone is open.
9	ENTRY/EXIT DELAY 2- A trip will start entry delay 2. The lack of a trip during exit delay will enable the Automatic Bypass or Instant mode if so programmed.
10	24-HOUR SILENT SUPERVISED- Creates an instant silent alarm regardless of the armed state of the control panel. It will display on the keypad.
11	KEYSWITCH ZONE - This zone type will arm and disarm the partition or partitions of the control panel that it resides in each time the zone is shorted. Keyswitch arming will report as user #99.
12	INTERIOR FOLLOWER WITH "CROSS ZONE" ENABLED - This zone will be instant when the system is armed and no entry or exit delay is being timed. It is delayed during entry and exit delay times. If a "Cross Zone" is not being timed it will start a "Cross Zone" timer. If a "Cross Zone" is being timed it will create an instant alarm. This zone will automatically bypass when enabled in Segment 1 of Location 23.
13	INSTANT ENTRY GUARD - This zone creates an instant alarm whenever it is tripped and the Stay LED is off. It will start an entry delay time 2 if it is tripped and the system is armed and the Stay LED is on.
14	ENTRY/EXIT DELAY 1 WITH GROUP BYPASS ENABLED - A trip will start entry delay 1. This zone will bypass when the "Group Bypass" command is entered at the keypad. The lack of a trip during exit delay will enable the Automatic Bypass or Instant mode if so programmed.

DATA	DESCRIPTION OF DEFAULT ZONE TYPES
15	INTERIOR FOLLOWER WITH GROUP BYPASS ENABLED - This zone will be instant when the system is armed and no entry or exit delays are being timed. It is delayed during entry/exit delay times. This zone will bypass when the "Group Bypass" command is entered at the keypad. This zone will automatically bypass if enabled in Segment 1 of Location 23.
16	INSTANT WITH GROUP BYPASS ENABLED - This zone creates an instant alarm whenever it is tripped and the Armed LED is on. This zone will bypass when the "Group Bypass" command is entered at the keypad.
17	ENTRY/EXIT DELAY 1 WITH TAMPER ENABLED - A trip will start entry delay 1. The lack of a trip during exit delay will enable the Automatic Bypass or Instant mode if so programmed. This zone type can be used to enable tamper on a wireless transmitter.
18	INTERIOR FOLLOWER WITH TAMPER AND AUTO-BYPASS ENABLED - This zone will be instant when the system is armed and no entry or exit delay is being timed. It is delayed during entry and exit delay times. This zone will automatically bypass if enabled in Segment 1 of Location 23. This zone type can be used to enable tamper on a wireless transmitter.
19	INSTANT WITH TAMPER ENABLED - This zone creates an instant alarm whenever it is tripped and the Armed LED is on. This zone type can be used to enable tamper on a wireless transmitter.
20	ENTRY/EXIT DELAY 2 WITH TAMPER ENABLED -A trip will start entry delay 2. The lack of a trip during exit delay will enable the Automatic Bypass or Instant mode if so programmed. This zone type can be used to enable tamper on a wireless transmitter.
21	GAS DETECTION - Creates an instant alarm regardless of the armed state of the control panel. It will display on the keypad and activate the keypad sounder.
22	LOW TEMP DETECTION - Creates an instant silent alarm regardless of the armed state of the control panel. It will display on the keypad and activate the keypad sounder.
23	HIGH TEMP DETECTION - Creates an instant silent alarm regardless of the armed state of the control panel. It will display on the keypad and activate the keypad sounder.
24	MANUAL FIRE - This zone will illuminate the Fire LED and sound the temporal siren each time the zone is shorted. It will also rapidly flash the Fire LED indicating a trouble if the zone is open.
25	CHIME ONLY - Creates no alarm regardless of the armed state of the control panel. It will chime anytime it is faulted and will display on the keypad. Local only.
26	INTERIOR FOLLOWER DELAY 2 - This zone will be instant when the system is armed and no entry or exit delay is being timed. It is delayed during entry and exit delay 2 times. This zone will automatically bypass if enabled in Segment 1 of Location 23.
27	INTERIOR FOLLOWER FORCE ARMABLE - This zone will be instant when the system is armed and no entry or exit delay is being timed. It is delayed during entry and exit delay 1 times. This zone will automatically bypass if enabled in Segment 1 of Location 23.
28	ENTRY/EXIT FORCE ARMABLE DELAY 2 - A trip will start entry delay 2. The lack of a trip during exit delay will enable the Automatic Bypass or Instant mode if so programmed.
29	INTERIOR FOLLOWER WITH ACTIVITY SUPERVISION ENABLED - This zone will be instant when the system is armed and no entry or exit delay is being timed. It is delayed during entry and exit delay times. It will send a report if the zone activity time is reached without a change of state. Refer to Location 40 / Segment 11. This zone will automatically bypass if enabled in Segment 1 of Location 23.
30	ENTRY/EXIT WITH ACTIVITY SUPERVISION ENABLED - A trip will start entry delay 1. It will send a report if the zone activity time is reached without a change of state. Refer to Location 40 / Segment 11. The lack of a trip during exit delay will enable the Automatic Bypass or Instant mode if so programmed.

 **LOCATION 25 - ZONES 1-8 ZONE TYPE (8 segments, numerical data)**

Location 25 contains the Zone Type for zones 1-8. Segment 1 is for zone 1, and Segment 8 is for zone 8. Default Zone Types are found in the table on page 19. To customize a Zone Type, see page 33.

LOCATION 26 - PARTITION SELECT, ZONES 1-8 (8 segments, feature selection data)

Location 26 is used to select the partition(s) that zones 1 - 8 reside in. A zone may reside in any combination of the 8 partitions. **If a burglary zone resides in more than 1 partition, it will only be active when all partitions are armed. A zone that resides in more than 1 partition will be reported to its lowest partition number.** Location 26 has 8 segments. Segment 1 corresponds to zone 1, and Segment 8 corresponds to zone 8.

Segments 1 - 8:

- | | | | |
|------------------|------------------|------------------|------------------|
| 1 = Partition #1 | 3 = Partition #3 | 5 = Partition #5 | 7 = Partition #7 |
| 2 = Partition #2 | 4 = Partition #4 | 6 = Partition #6 | 8 = Partition #8 |

 **LOCATION 27 - ZONES 9-16 ZONE TYPE (8 segments, numerical data)**

Location 27 contains the Zone Type for zones 9 -16. Segment 1 is for zone 9; Segment 8 is for zone 16. Default Zone Types are found in the table on page 19. To customize a Zone Type, see page 33.

LOCATION 28 - PARTITION SELECT, ZONES 9-16 (8 segments, feature selection data)

Location 28 is used to select the partition(s) that zones 9-16 reside in. A zone may reside in any combination of the 8 partitions. **If a burglary zone resides in more than 1 partition, it will only be active when all partitions are armed. A zone that resides in more than 1 partition will be reported to its lowest partition.** Location 28 has 8 segments. Segment 1 corresponds to zone 9 and Segment 8 corresponds to zone 16.

Segments 1 - 8:

1 = Partition #1	3 = Partition #3	5 = Partition #5	7 = Partition #7
2 = Partition #2	4 = Partition #4	6 = Partition #6	8 = Partition #8

 **LOCATION 29 - ZONES 17-24 ZONE TYPE (8 segments, numerical data)**

Location 29 contains the Zone Type for zones 17-24. Segment 1 is for zone 17; Segment 8 is for zone 24. Default Zone Types are found in the table on page 19. To customize a Zone Type, see page 33.

LOCATION 30 - PARTITION SELECT, ZONES 17-24 (8 segments, feature selection data)

Location 30 is used to select the partition(s) that zones 17-24 reside in. A zone may reside in any combination of the 8 partitions. **If a burglary zone resides in more than 1 partition, it will only be active when all partitions are armed. A zone that resides in more than 1 partition will be reported to its lowest partition.** Location 30 has 8 segments. Segment 1 corresponds to zone 17 and Segment 8 corresponds to zone 24.

Segments 1 - 8:

1 = Partition #1	3 = Partition #3	5 = Partition #5	7 = Partition #7
2 = Partition #2	4 = Partition #4	6 = Partition #6	8 = Partition #8

 **LOCATION 31 - ZONES 25-32 ZONE TYPE GROUP (8 segments, numerical data)**

Location 31 contains the Zone Type for zones 25-32. Segment 1 is for zone 25; Segment 8 is for zone 32. Default Zone Types are found in the table on page 19. To customize a Zone Type, see page 33.

LOCATION 32 - PARTITION SELECT, ZONES 25-32 (8 segments, feature selection data)

Location 32 is used to select the partition(s) that zones 25-32 reside in. A zone may reside in any combination of the 8 partitions. **If a burglary zone resides in more than 1 partition it will only be active when all partitions are armed. A zone that resides in more than 1 partition will be reported to its lowest partition.** Segment 1 corresponds to zone 25 and Segment 8 corresponds to zone 32.

Segments 1 - 8:

1 = Partition #1	3 = Partition #3	5 = Partition #5	7 = Partition #7
2 = Partition #2	4 = Partition #4	6 = Partition #6	8 = Partition #8

 **LOCATION 33 - ZONES 33-40 ZONE TYPE (8 segments, numerical data)**

Location 33 contains the Zone Type for zones 33-40. Segment 1 is for zone 33 Segment 8 is for zone 40. Default Zone Types are found in the table on page 19. To customize a Zone Type, see page 33.

LOCATION 34 - PARTITION SELECT, ZONES 33-40 (8 segments of feature selection data)

Location 34 is used to select the partition(s) that zones 33-40 reside in. A zone may reside in any combination of the 8 partitions. **If a burglary zone resides in more than 1 partition, it will only be active when all partitions are armed. A zone that resides in more than 1 partition will be reported to its lowest partition.** Segment 1 corresponds to zone 33 and Segment 8 corresponds to zone 40.

Segments 1 - 8:

1 = Partition #1	3 = Partition #3	5 = Partition #5	7 = Partition #7
2 = Partition #2	4 = Partition #4	6 = Partition #6	8 = Partition #8

 **LOCATION 35 - ZONES 41-48 ZONE TYPE (8 segments of numerical data)**

Location 35 contains the Zone type for zones 41-48. Segment 1 is for zone 41 Segment 8 is for zone 48. Default Zone Types are found in the table on page 19. To customize a Zone Type, see page 33.

LOCATION 36 - PARTITION SELECT, ZONES 41-48 (8 segments, feature selection data)

Location 36 is used to select the partition or partitions that zones 41-48 reside in. A zone may reside in any combination of the 8 partitions. **If a burglary zone resides in more than 1 partition it will only be active when all partitions are armed. A zone that resides in more than 1 partition will be reported to its lowest partition.** Location 36 has 8 segments. Segment 1 corresponds to zone 41 and Segment 8 corresponds to zone 48.

Segments 1 - 8:

1 = Partition #1	3 = Partition #3	5 = Partition #5	7 = Partition #7
2 = Partition #2	4 = Partition #4	6 = Partition #6	8 = Partition #8

 **LOCATION 37 - SIREN AND SYSTEM SUPERVISION (7 segments, feature selection data)**

Location 37 is used to enable various system feature and reporting options. (Refer to the feature definitions.)

Segment 1:

- 1 - On if siren sounds for "Telephone Line Cut" when armed.
- 2 - On if siren sounds for "Telephone Line Cut" when disarmed.
- 3 - On if siren blast at arming.
- 4 - On if siren blast at exit expiration.
- 5 - On if siren blast at closing kiss-off.
- 6 - On if siren sounds during a "Cross Zone" verification time.
- 7 - On if siren sounds for a Zone or Box Tamper.
- 8 - On if siren blasts 1 time for keyswitch or wireless arming; 2 times for disarming. (**NOTE:** Must be disabled for SIA CP-01 installations.)

Segment 2:

- 1 - On if siren driver should be a voltage output. Off if on board siren driver enabled.
- 2 - On if siren sounds for expander trouble (required for UL installations).
- 3 - On for Immediate Restore by zone. Off for zones to restore only when siren is off.
- 4 - On if Dynamic Battery Test performed at arming. Off if performed at disarming. (See location 40)
- 5 - On if Battery Missing Test is performed every 12 seconds.
- 6 - On if Manual Bell Test performed during [*]-[4]-[4] test function.
- 7 - On if Manual Communicator Test performed during [*]-[4]-[4] test function.
- 8 - On if Box Tamper terminals on the control panel are enabled.

Segment 3:

- 1 - On if Box Tamper report enabled.
- 2 - On if AC Fail reporting enabled.
- 3 - On if Low Battery reporting enabled.
- 4 - On if Aux. Power Overcurrent report enabled.
- 5 - On if Siren Supervision report enabled.
- 6 - On if Telephone Line Cut report enabled.
- 7 - On if Ground Fault Detection report enabled.
- 8 - On if Expander Trouble reporting enabled.

Segment 4:

- 1 - On if Fail To Communicate report enabled.
- 2 - On if Log Full report enabled.
- 3 - On if Autotest report enabled.
- 4 - On if Start/End programming report enabled.
- 5 - On if End Download report enabled.
- 6 - On if Sensor Low Battery report enabled.
- 7 - On if Sensor Missing report enabled.
- 8 - On if First to Open / Last to Close.

Segment 5:

- 1 = On enable Lost Clock service light.
- 2 = On enables Zone Doubling (requires NX-200 Zone Doubling Kit).
- 3 = On disables On-Board 8 zones.
- 4 = On will allow two trips on same cross-zone to activate an alarm.
- 5 = On will **not** allow zones that are force armed to report bypass.
- 6 = Reserved.
- 7 = Use internal crystal for clock.
- 8 = Disable Temporal Siren on Fire. **NOTE: Do NOT disable for UL listed systems.**

- Segment 6:** 1 = Enable 2 wire smoke.
 2 = Reserved.
 3 = Enable for Zone Activity in Hours (not Days)
 4 = Enable Daylight Savings Time (DST)
 5 = Reserved
 6 = On to disable Clean Me report (Clean Me report is enabled at default)
 7-8 = Reserved.

Segment 7: Reserved

 **LOCATION 38 - SWINGER SHUTDOWN COUNT**

Location 38 contains the number of trips during an arming cycle that the NX-8E will allow before bypassing a zone. The count determination is described in the feature definitions beginning on page 4. **Factory default is 1.**

 **LOCATION 39 - KEYPAD SOUNDER CONTROL (1 segment, feature selection data)**

- Segment 1:** 1 - On if keypad sounds for "Telephone Line Cut" when the system is armed.
 2 - On if keypad sounds for "Telephone Line Cut" when disarmed.
 3 - On if keypad sounds upon AC Power Failure.
 4 - On if keypad sounds when a Low Battery is detected.
 5 - On if keypad sounds during Cross Zone trip time.
 6 - On if keypad sounds for zone and box tampers.
 7 - Reserved.
 8 - On if keypad sounds for expander trouble (required for UL installations).

 **LOCATION 40 - SYSTEM TIMERS (14 segments, numerical data)**

Location 40 contains the duration of various system timing functions. Example: If you desire the duration of the Dynamic Battery Test to be 30 minutes, you should program [3]-[0]-[*] in segment 1 of this location. The [3]-[0] is the number of minutes, and the [*] stores the data and moves to the next segment of this location.

- Segment 1** - Dynamic Battery Test duration in minutes 0-255 minutes. (Default is 0 = no test)
Segment 2 - AC Fail report delay in minutes 0-255 minutes. (Default is 5 minutes)
Segment 3 - Power Up Delay in seconds 0-60 seconds. (0 = no power up delay) (Default is 60 seconds)
Segment 4 - Siren Time in minutes 1-254 minutes. (Default is 8 minutes)
Segment 5 - Telephone Line Cut delay in seconds 0-255 seconds. (Default is 0 = no TLM)
Segment 6 - Cross Zone time in minutes 0-255 (0 = no cross zoning) (Default is 5 minutes)
Segment 7 - Chime time in 50mS (1/20th second) increments from 0-12 seconds (0 = follows zone 255 latched)
Segment 8 - Dial delay in seconds 15-255 seconds. (Default is 30 seconds)
Segment 9 - Fire Alarm Verification time in seconds 120-255 seconds. (Default is 0 = no verification) **NOTE:**
This feature is not approved for residential use in California.
Segment 10 -Listen-In time in seconds 0-255. (Default is 0 = no Listen-In time)
Segment 11 -Zone Activity Monitor feature timed in days 0 – 255. (Default is 0 = disabled)
Segments 12-14 Reserved.

Note for UL listed systems: The "Listen-In" feature cannot be enabled. The "Dynamic Battery Test" feature cannot exceed four (4) hours.

LOCATION 41 - SPECIAL FEATURES (1 segment, feature selection data)

Segment 1:

- 1 - On enables the 6-digit code option. If 6-digit option is enabled, all arm/disarm codes and the "Go To Program Code" are 6 digits. If this option is enabled, the default user 1 code is [1]-[2]-[3]-[4]-[5]-[6]. **NOTE: IF YOU ENABLE THIS OPTION, VERIFY THAT THE "GO TO PROGRAM CODE" IS A SIX-DIGIT CODE BEFORE EXITING PROGRAMMING.**
- 2 - On requires code entry for [*]-[9]-[8] (perform call back download) and [*]-[9]-[9] (answer incoming call for download) functions.
- 3 - Enable Auto Cancel / Abort (Refer to feature definitions beginning on page 4)
- 4 - Enable Walk-Test Mode (Refer to feature definitions beginning on page 4)
- 5 - Enables Auto Force-arming with keyfob or keyswitch.
- 6-8 Reserved.

 **LOCATION 42 - GO TO PROGRAM CODE (6 segments, numerical data)**

Location 42 contains the "Go To Program Code". This location contains either a 4 or 6-digit code. If the 6-digit code option is enabled in Location 41, THIS CODE MUST CONTAIN SIX (6) DIGITS. If this option is not enabled in location 41, the last 2 segments (digits) will be ignored. With the NX-8E disarmed, the "Go To Program Code" can be used to enter the Program Mode.

LOCATION 43 - GO TO PROGRAM CODE PARTITION AND AUTHORIZATION (2 segments, feature selection)

The "Go To Program Code" can be used as a standard arm/disarm code. When using the code to arm or disarm, the user ID is 255. (This code may not be changed in the Run Mode.)

- Segment 1:**
- 1 - Reserved.
 - 2 - On enables "Go To Program Code" as an arm only code.
 - 3 - On enables "Go To Program Code" as an arm only after closing.
 - 4 - On enables "Go To Program Code" as a master arm/disarm code (can change user codes)
 - 5 - On enables "Go To Program Code" as an arm/disarm code.
 - 6 - On enables "Go To Program Code" to bypass zones.
 - 7 - On enables "Go To Program Code" opening and closing reports.
 - 8 - Reserved.

- Segment 2:**
- 1 - On enables the "Go To Program Code" for Partition #1.
 - 2 - On enables the "Go To Program Code" for Partition #2.
 - 3 - On enables the "Go To Program Code" for Partition #3.
 - 4 - On enables the "Go To Program Code" for Partition #4.
 - 5 - On enables the "Go To Program Code" for Partition #5.
 - 6 - On enables the "Go To Program Code" for Partition #6.
 - 7 - On enables the "Go To Program Code" for Partition #7.
 - 8 - On enables the "Go To Program Code" for Partition #8.

 **LOCATION 44 - DURESS CODE (6 segments, numerical data)**

Location 44 contains the "Duress" code. This Location contains either 4 or 6 digits. If the 6-digit code option is enabled in Location 41, THIS CODE MUST CONTAIN SIX (6) DIGITS. If the 6-digit option is not enabled in location 41, the last 2 digits will be ignored. **If the duress code is programmed, it will work for all partitions.**

LOCATION 45 - AUXILIARY OUTPUT 1-4 PARTITION SELECTION (4 segments, feature selection data)

Location 45 is used to select which partition(s) the events must occur in before the output will activate. Location 45 has 4 segments. Segment 1 corresponds to output 1, and Segment 4 corresponds to output 4.

<u>Segment 1 (Aux 1)</u>	<u>Segment 2 (Aux 2)</u>	<u>Segment 3 (Aux 3)</u>	<u>Segment 4 (Aux 4)</u>
1= Partition #1	1= Partition #1	1= Partition #1	1= Partition #1
2= Partition #2	2= Partition #2	2= Partition #2	2= Partition #2
3= Partition #3	3= Partition #3	3= Partition #3	3= Partition #3
4= Partition #4	4= Partition #4	4= Partition #4	4= Partition #4
5= Partition #5	5= Partition #5	5= Partition #5	5= Partition #5
6= Partition #6	6= Partition #6	6= Partition #6	6= Partition #6
7= Partition #7	7= Partition #7	7= Partition #7	7= Partition #7
8= Partition #8	8= Partition #8	8= Partition #8	8= Partition #8

LOCATION 46 - AUXILIARY OUTPUT 1-4 SPECIAL TIMING (4 segments, feature selection data)

Location 46 contains special timing feature activation for the four auxiliary outputs. Segment 1 corresponds to output 1; Segment 4 corresponds to output 4.

- Segments 1 - 4:**
- 1 = On if output should be timed in minutes; Off if timed in seconds.
 - 2 = On if output should latch; Off if output should be timed.
 - 3 = On if output should stop timing upon code entry; Off if the output should continue to time upon code entry.
 - 4 = On if output should only activate between the closing and opening time in loc. 52 and 53.
 - 5 = On if output should only activate between the opening and closing time in loc. 52 and 53.
 - 6 = On if output should be inverted (0 volts going to 12 volts when activated).
 - 7 = Reserved.
 - 8 = Reserved.

LOCATION 47 - AUXILIARY OUTPUT #1, EVENT AND TIME (2 segments, numerical data)

- Segment 1:** Use Table XI-1 on page 25 to select the event that will activate Auxiliary Output 1.
- Segment 2:** Program the timing from 0-255 (minutes or seconds, depending on data programmed in Segment 1, Location 46). Programming a "0" makes the output follow the event.

LOCATION 48 - AUXILIARY OUTPUT #2, EVENT AND TIME (2 segments, numerical data)

- Segment 1:** Use Table XI-1 on page 25 to select the event that will activate Auxiliary Output 2.
- Segment 2:** Program the timing from 0-255 (minutes or seconds, depending on data programmed in Segment 2, Location 46). Programming a "0" makes the output follow the event.

LOCATION 49- AUXILIARY OUTPUT #3, EVENT AND TIME (2 segments, numerical data)

- Segment 1:** Use Table XI-1 on page 25 to select the event that will activate Auxiliary Output 3.
- Segment 2:** Program the timing from 0-255 (minutes or seconds, depending on data programmed in Segment 3, Location 46). Programming a "0" makes the output follow the event.

LOCATION 50- AUXILIARY OUTPUT #4, EVENT AND TIME (2 segments, numerical data)

- Segment 1:** Use Table XI-1 on page 25 to select the event that will activate Auxiliary Output 4.
- Segment 2:** Program the timing from 0-255 (minutes or seconds, depending on data programmed in Segment 4, Location 46). Programming a "0" makes the output follow the event.

Table XI-1 AUXILIARY OUTPUT EVENT SELECTION

DATA	EVENT	DATA	EVENT	DATA	EVENT
0 ✓	Burglary Alarm	19	Exit	38	Download In Process
1 ✓	Fire Alarm	20	Entry or Exit	39	Smoke Power
2 ✓	24 Hour Alarm	21	Armed State	40	Short Circuit (Over-current)
3 ✓	Trouble Alarm	22	Disarmed State	41	Box Tamper
4 ✓	Tamper Alarm	23	Ready	42	Siren Tamper
5	Yelping Siren (Burglary)	24	Not Ready	43	Any Open
6	Temporal Siren (Fire)	25	Fire	44	Any Short
7	Any Siren	26	Fire Trouble	45	Any Fault (Open/ Short on Non-Fire Zone)
8	Any Bypass	27	Chime	46 ✓	Any Alarm
9	AC Fail	28 ✓	Expander Trouble	47	Beeping Keypad
10	Low Battery	29	Dynamic Battery Test Time	48 ✓	Code Entry (See note below)
11 ✓	Duress	30	Open Period	49 ❖ ✓	Key FOB Function 1
12 ✓	Aux 1 Keypad Zone	31	Closed Period	50 ❖ ✓	Key FOB Function 2
13 ✓	Aux 2 Keypad Zone	32	Listen-In	51	Always ON
14 ✓	Panic Keypad Zone	33	Line Seizure	52	Alarm Flash
15	Keypad Tamper	34	Ground Start	53	Armed Away
16 ✓	Autotest	35	Fail To Communicate	54	Armed Stay
17	Alarm Memory	36	Telephone Line Fault	55	Aux Comm Fail
18	Entry	37	Program Mode	56	(CP-01) Progress Annunciation

❖ Events 49 & 50 require one or more of the following to operate: NX-408E, NX-416E, NX-448E wireless receivers, or NX-1700E card reader.

✓ If set to follow condition, these events will be 1 second.

Notes: When Event 48 is programmed, it is possible to program a user code's authorization to select which output(s) a particular code will activate. When LED 8 is on for an authorization, then LEDs 1- 4 correspond to that code activating outputs 1 - 4 respectively. **(See programming the LED keypads on page 8.)**

 **LOCATION 51 - AUTOTEST CONTROL (4 segments, numerical data)**

- Segment 1:** Program a "1" if the interval is to be in hours; Program a "0" if in days. Add a "2" to suppress the daily test or a "3" to suppress the hourly test if any report has been sent.
- Segment 2:** Program the Autotest interval from 1-255 hours/days.
- Segment 3:** Program the Autotest report hour in 24-hour format (if the interval is in hours, this segment is ignored).
- Segment 4:** Program the Autotest report time, number of minutes after the hour.

LOCATION 52 - OPENING TIME (2 segments, numerical data)

Location 52 contains the time in 24 hour format the NX-8E enables codes designated as arm only after closing. This time is only valid on those days programmed in location 54. **Note:** Opening time must be earlier than closing time for Auto Arm, Aux. Outputs, or Code Authorization to function properly.

- Segment 1:** Program the hour of the opening time.
- Segment 2:** Program the minutes after the hour of the opening time.

LOCATION 53 - CLOSING TIME/AUTOMATIC ARMING TIME (2 segments, numerical data)

Location 53 contains the time in 24 hour format the NX-8E disables the disarm capability for codes designated as arm only after closing. This is also the time the Automatic Arming sequence will begin (if enabled in location 55)..

- Segment 1:** Program the hour of the closing / auto arm time.
- Segment 2:** Program the minutes after the hour of the closing / auto arm time.

LOCATION 54 - DAYS OF THE WEEK EACH PARTITION IS OPEN (8 Segments, feature selection data)

Location 54 selects which days of the week each partition is open. On these days, "arm only after close window" codes will be able to arm and disarm during open window. **NOTE: If any partition is not programmed to be opened and is programmed to Auto-Arm (Location 55), the NX-8E will try to arm every 45 minutes for the duration of the closed period unless Auto Retry is disabled in location 55.** On days not selected here, "arm only after close window" codes will not disarm. Segment 1 is for partition 1, and segment 8 is for partition 8. (See locations 52 and 53 for the opening and closing times for the open days.)

- Segment 1-8:**
- 1 - Open on Sunday.
 - 2 - Open on Monday.
 - 3 - Open on Tuesday.
 - 4 - Open on Wednesday.
 - 5 - Open on Thursday.
 - 6 - Open on Friday.
 - 7 - Open on Saturday.
 - 8 - Reserved.

LOCATION 55 - DAYS OF THE WEEK FOR AUTO ARMING IN PARTITIONS 1 THRU 8 (8 Segments, feature selection data)

Location 55 selects which days each partition will auto arm. Segment 1 is for partition 1, and segment 8 is for partition 8. If a zone is faulted when the panel tries to auto arm, the zone will be bypassed.

- Segments 1-8:**
- 1 - Auto Arming on Sunday.
 - 2 - Auto Arming on Monday.
 - 3 - Auto Arming on Tuesday.
 - 4 - Auto Arming on Wednesday.
 - 5 - Auto Arming on Thursday.
 - 6 - Auto Arming on Friday.
 - 7 - Auto Arming on Saturday.
 - 8 - Disable 45 minute retry timer.

LOCATIONS 56- 83 ARE ONLY USED WHEN REPORTING EVENTS TO A PAGER OR USING A SLOW FORMAT SUCH AS 4+2. WHEN USING CONTACT ID OR SIA, THERE IS NO NEED TO PROGRAM THESE LOCATIONS.

The digit programmed in each of the following locations will be sent as the upper HEX digit in place of the alarm event code. The zone ID or user ID will always be reported as the lower HEX digit (1-F). For example, if the zone ID or user ID is 15, the 4+2 lower digit will be "F" and if the zone ID or user ID is 16, the 4+2 digit will be "1". See Appendix 4 on page 72. **NOTE:** If Segments 2-8 are left as "0" (unprogrammed), they will follow the Segment 1 selection. If Segment 1 is left as "0" and the feature is enabled in Location 23, the NX-8E will report "A".

LOCATION 56 - RESTORE COMMUNICATOR CODE (8 segments, numerical data)

Location 56 contains the event code for any zone "Restore" for a 4+2 format. Refer to the box at the top of page 27.

Segment 1 = Partition 1 **Segment 3** = Partition 3 **Segment 5** = Partition 5 **Segment 7** = Partition 7
Segment 2 = Partition 2 **Segment 4** = Partition 4 **Segment 6** = Partition 6 **Segment 8** = Partition 8

LOCATION 57 - BYPASS COMMUNICATOR CODE (8 segments, numerical data)

Location 57 contains the event code for a zone "Bypass" for a 4+2 format. Refer to the box at the top of page 27.

Segment 1 = Partition 1 **Segment 3** = Partition 3 **Segment 5** = Partition 5 **Segment 7** = Partition 7
Segment 2 = Partition 2 **Segment 4** = Partition 4 **Segment 6** = Partition 6 **Segment 8** = Partition 8

LOCATION 58 - TAMPER COMMUNICATOR CODE (8 segments, numerical data)

Location 58 contains the event code for a zone "Tamper" for a 4+2 format. Refer to the box at the top of page 27.

Segment 1 = Partition 1 **Segment 3** = Partition 3 **Segment 5** = Partition 5 **Segment 7** = Partition 7
Segment 2 = Partition 2 **Segment 4** = Partition 4 **Segment 6** = Partition 6 **Segment 8** = Partition 8

LOCATION 59 - TROUBLE COMMUNICATOR CODE (8 segments, numerical data)

Location 59 contains the event code for a zone "Trouble" for a 4+2 format. Refer to the box at the top of page 27.

Segment 1 = Partition 1 **Segment 3** = Partition 3 **Segment 5** = Partition 5 **Segment 7** = Partition 7
Segment 2 = Partition 2 **Segment 4** = Partition 4 **Segment 6** = Partition 6 **Segment 8** = Partition 8

LOCATION 60 - SENSOR LOW BATTERY COMMUNICATOR CODE (8 segments, numerical data)

Location 60 contains the event code for a zone "Sensor Low Battery" for a 4+2 format. Refer to the box at the top of page 27.

Segment 1 = Partition 1 **Segment 3** = Partition 3 **Segment 5** = Partition 5 **Segment 7** = Partition 7
Segment 2 = Partition 2 **Segment 4** = Partition 4 **Segment 6** = Partition 6 **Segment 8** = Partition 8

LOCATION 61- SENSOR MISSING COMMUNICATOR CODE (8 segments, numerical data)

Location 61 contains the event code for a zone "Sensor Missing" for a 4+2 format. Refer to the box at the top of page 27.

Segment 1 = Partition 1 **Segment 3** = Partition 3 **Segment 5** = Partition 5 **Segment 7** = Partition 7
Segment 2 = Partition 2 **Segment 4** = Partition 4 **Segment 6** = Partition 6 **Segment 8** = Partition 8

LOCATION 62 - DURESS COMMUNICATOR CODE (2 segments, numerical data)

Location 62 contains the digits that will be sent for a 4+2 format if the "Duress" code is enabled in location 44. Refer to the box at the top of page 27.

LOCATION 63 - KEYPAD AUXILIARY 1 COMMUNICATOR CODE (2 segments, numerical data)

Location 63 contains the digits that will be sent for a 4+2 format if the keypad "Auxiliary 1" (Fire) is enabled in the partition feature selection. Refer to the box at the top of page 27.

SLOW COMMUNICATOR FORMAT CODES

LOCATION 64 - KEYPAD AUXILIARY 2 COMMUNICATOR CODE (2 segments, numerical data)

Location 64 contains the digits that will be sent for a 4+2 format if the keypad "Auxiliary 2" (Medical) is enabled in the partition feature selection. Refer to the box at the top of page 27.

LOCATION 65 - KEYPAD PANIC COMMUNICATOR CODE (2 segments, numerical data)

Location 65 contains the digits that will be sent for a 4+2 format if the keypad "Panic" is enabled in the partition feature selection. Refer to the box at the top of page 27.

LOCATION 66 - KEYPAD MULTIPLE CODE ENTRY TAMPER COMMUNICATOR CODE (2 segments, numerical data)

Location 66 contains the digits that will be sent for a 4+2 format if the keypad "Multiple Code Entry" (Tamper) is enabled in the partition feature selection. Refer to the box at the top of page 27.

LOCATION 67 - BOX TAMPER / BOX TAMPER RESTORE COMMUNICATOR CODE (4 segments, numerical data)

Location 67 contains the digits that will be sent for a 4+2 format if the "Box Tamper" feature is enabled in location 37. Segments 1 & 2 contain the digits of the "Box Tamper". Segments 3 & 4 contain the digits of the "Box Tamper Restore". Refer to the box at the top of page 27.

LOCATION 68 - AC FAIL / AC FAIL RESTORE COMMUNICATOR CODES (4 segments, numerical data)

Location 68 contains the digits for a 4+2 format that will be sent if "AC Fail Reporting" is enabled. Segments 1 & 2 contain the digits of the "AC Fail". Segments 3 & 4 contain the digits of the "AC Fail Restore". Refer to the box at the top of page 27.

LOCATION 69 - LOW BATTERY / LOW BATTERY RESTORE COMMUNICATOR CODES, SLOW SPEED FORMATS ONLY (4 segments, numerical data)

Location 69 contains the digits for a 4+2 format that will be sent if "Low Battery Reporting" is enabled. Segments 1 & 2 contain the digits of the "Low Battery Reporting". Segments 3 & 4 contain the digits of the "Low Battery Restore". Refer to the box at the top of page 27.

LOCATION 70 - AUX POWER OVERCURRENT/ AUX POWER OVERCURRENT RESTORE COMMUNICATOR CODES (4 segments, numerical data)

Location 70 contains the digits for a 4+2 format that will be sent if "Aux Power Overcurrent Reporting" is enabled. Segments 1 & 2 contain the digits of the "Aux Power Overcurrent Reporting". Segments 3 & 4 contain the digits of the "Aux Power Overcurrent Restore". Refer to the box at the top of page 27.

LOCATION 71 - BELL TAMPER / BELL TAMPER RESTORE COMMUNICATOR CODES (4 segments, numerical data)

Location 71 contains the digits for a 4+2 format that will be sent if siren supervision reporting is enabled. Segments 1 & 2 contain the digits of the "Bell Tamper Reporting". Segments 3 & 4 contain the digits of the "Bell Tamper Restore". Refer to the box at the top of page 27.

LOCATION 72 - TELEPHONE LINE CUT / TELEPHONE LINE CUT RESTORE COMMUNICATOR CODES (4 segments, numerical data)

Location 72 contains the digits for a 4+2 format that will be sent if "Telephone Line Cut Reporting" is enabled. Segments 1 & 2 contain the digits of the "Telephone Line Cut Reporting". Segments 3 & 4 contain the digits of the "Telephone Line Cut Restore". Refer to the box at the top of page 27.

LOCATION 73 - GROUND FAULT / GROUND FAULT RESTORE COMMUNICATOR CODES (4 segments, numerical data)

Location 73 contains the digits for a 4+2 format that will be sent if "Ground Fault Reporting" is enabled, and the NX-870E is installed. Segments 1 & 2 contain the digits of the "Ground Fault Reporting". Segments 3 & 4 contain the digits of the "Ground Fault Restore". Refer to the box on page 27.

SLOW COMMUNICATOR FORMAT CODES

LOCATION 74 - EXPANDER TROUBLE / EXPANDER TROUBLE RESTORE COMMUNICATOR CODES (4 segments, numerical data)

Location 74 contains the digits for a 4+2 format that will be sent if "Expander Trouble Reporting" is enabled. Segments 1 & 2 contain the digits of the "Expander Trouble Reporting". Segments 3 & 4 contain the digits of the "Expander Trouble Restore". Refer to the box on page 27.

LOCATION 75 - FAIL TO COMMUNICATE COMMUNICATOR CODE (2 segments, numerical data)

Location 75 contains the digits for a 4+2 format that will be sent if the "Fail To Communicate Reporting" is enabled. Refer to the box on page 27.

LOCATION 76 - LOG FULL COMMUNICATOR CODE (2 segments, numerical data)

Location 76 contains the digits for a 4+2 format if the "Log Full Reporting" is enabled. Refer to the box on page 27.

LOCATION 77 - OPENING COMMUNICATOR CODE (8 segments, numerical data)

Location 77 contains the digit of a 4+2 format if the "Opening Reporting" is enabled. Refer to the box on page 27.

Segment 1 = Partition 1	Segment 3 = Partition 3	Segment 5 = Partition 5	Segment 7 = Partition 7
Segment 2 = Partition 2	Segment 4 = Partition 4	Segment 6 = Partition 6	Segment 8 = Partition 8

LOCATION 78 - CLOSING COMMUNICATOR CODE (8 segments, numerical data)

Location 78 contains the digit of a 4+2 format if the "Closing Reporting" is enabled. Refer to the box on page 27.

Segment 1 = Partition 1	Segment 3 = Partition 3	Segment 5 = Partition 5	Segment 7 = Partition 7
Segment 2 = Partition 2	Segment 4 = Partition 4	Segment 6 = Partition 6	Segment 8 = Partition 8

LOCATION 79 - AUTOTEST COMMUNICATOR CODE (2 segments, numerical data)

Location 79 contains the digits for a 4+2 format that will be sent if the "Autotest" or "Manual Test" is enabled. Refer to the box on page 27.

LOCATION 80 - RECENT CLOSING AND EXIT ERROR COMMUNICATOR CODE (2 segments, numerical data)

Location 80 contains the digits for a 4+2 format that will be sent if "Recent Closing" and/or "Exit Error Reporting" is enabled. Segment 1 contains the digit for the "Recent Closing Reporting". Segment 2 contains the digit for the "Exit Error Reporting". Refer to the box on page 27.

LOCATION 81 - START PROGRAM AND END PROGRAM COMMUNICATOR CODES (4 segments, numerical data)

Location 81 contains the digits for a 4+2 format that will be sent if "Start / End Programming Reporting" is enabled. Segment 1 contains the digit for the "Start Program Reporting". Segment 2 contains the digit for the "Start Program Reporting". Segment 3 contains the digit for the "End Program Reporting". Segment 4 contains the digit for the "End Program Reporting". Refer to the box on page 27.

LOCATION 82 - END DOWNLOAD COMMUNICATOR CODE (4 segments, numerical data)

Location 82 contains the digits for a 4+2 format that will be sent if "End Downloading Reporting" is enabled. Segment 1 and 2 are *Reserved*. Segment 3 contains the digit of the "End Download Reporting". Segment 4 contains the digit of the "End Download Reporting". **Note:** A start download report will be sent to the internal event log. Refer to the box on page 27.

LOCATION 83 - CANCEL COMMUNICATOR CODE (1 segments, numerical data)

Location 83 contains the digit for a 4+2 format that will be sent if "Cancel Reporting" is enabled. Segment 1 contains the digit for the "Cancel Communicator Reporting". Refer to the box on page 27.

LOCATIONS 84-87 RESERVED.

LOCATIONS 88-109 ARE FOR PROGRAMMING DIFFERENT ACCOUNT CODES AND/OR FEATURES FOR EACH PARTITION. IF A LOCATION IS LEFT UNPROGRAMMED, THE FEATURE FOR PARTITION 1 AND ACCOUNT CODE FOR THE PHONE NUMBER WILL BE USED.

LOCATION 88 - ACCOUNT CODE FOR PARTITION 1 (6 segments, numerical data)

Location 88 contains the account code sent when partition 1 is reported. **If location 88 is left unprogrammed (all "10"s), then the account code corresponding to the Phone number dialed will be used.** If the account code is less than six digits, program a "10" in the segment immediately after the last digit of the account code. If the account code is 6 digits long, program all 6 segments.

LOCATION 89 - ACCOUNT CODE FOR PARTITION 2 (6 segments, numerical data)

Location 89 contains the account code sent when partition 2 is reported. **If location 89 is left unprogrammed (all "10"s), then the account code corresponding to the Phone number dialed will be used.** If the account code is less than six digits, program a "10" in the segment immediately after the last digit of the account code. If the account code is 6 digits long program all 6 segments.

LOCATION 90 - PARTITION 2 FEATURE AND REPORTING SELECTIONS (5 segments, feature selection data)

Location 90 is used to enable certain features that can be accessed or are visible to the user from the keypad of the system. In addition, certain communicator reports are enabled in this location. Each of these features can be enabled by partition. This location contains 5 segments, with eight possible features per segment. Refer to Location 23 (page 18) for the feature selections. **If all segments are blank (nothing enabled), the features for partition 1 will be used.**

LOCATION 91 - PARTITION 2 ENTRY EXIT TIMERS (6 segments, numerical data)

Location 91 is used to enter in seconds the Entry and Exit times. There are 2 separate entry and exit times. Valid entries are 10-255 seconds. **If all segments are "0", the entry and exit times for partition 1 will be used.**

Segment 1, Entry time 1: Entry time that will be used when a Delay 1 zone type initiates an entry delay.

Segment 2, Exit time 1: Exit time that will be used for all zones designated as Delay 1.

Segment 3, Entry time 2: Entry time that will be used when a Delay 2 zone type initiates an entry delay.

Segment 4, Exit time 2: Exit time that will be used for all zones designated as Delay 2.

Segments 5 & 6: Reserved

LOCATION 92 - ACCOUNT CODE FOR PARTITION 3 (6 segments, numerical data)

The account code sent when partition 3 is reported is programmed in location 92. **If location 92 is left unprogrammed (all "10") then the account code corresponding to the Phone number dialed will be used.** If the account code is less than six digits, program a "10" in the segment immediately after the last digit of the account code. If the account code is 6 digits long program all 6 segments.

LOCATION 93 - PARTITION 3 FEATURE AND REPORTING SELECTIONS (5 segments, feature selection data)

Location 93 is used to enable certain features that can be accessed or are visible to the user from the keypad of the system. In addition, certain communicator reports are enabled in this location. Each of these features can be enabled by partition. This location contains 5 segments, with eight possible features per segment. Refer to Location 23 (page 18) for the feature selections. **If all segments are blank (nothing enabled), the features for partition 1 will be used.**

LOCATION 94 - PARTITION 3 ENTRY EXIT TIMERS (6 segments, numerical data)

Location 94 is used to enter in seconds the Entry and Exit times. There are 2 separate entry and exit times. Valid entries are 10-255 seconds. **If all segments are "0", the entry and exit times for partition 1 will be used.**

Segment 1, Entry time 1: Entry time that will be used when a Delay 1 zone type initiates an entry delay.

Segment 2, Exit time 1: Exit time that will be used for all zones designated as Delay 1.

Segment 3, Entry time 2: Entry time that will be used when a Delay 2 zone type initiates an entry delay.

Segment 4, Exit time 2: Exit time that will be used for all zones designated as Delay 2.

Segments 5 & 6: Reserved

LOCATION 95 - ACCOUNT CODE FOR PARTITION 4 (6 segments, numerical data)

The account code sent when partition 4 is reported is programmed in location 95. **If location 95 is left unprogrammed (all "10") then the account code corresponding to the Phone number dialed will be used.** If the account code is less than six digits, program a "10" in the segment immediately after the last digit of the account code. If the account code is 6 digits long, program all 6 segments.

LOCATION 96 - PARTITION 4 FEATURE AND REPORTING SELECTIONS (5 segments, feature selection data)

Location 96 is used to enable certain features that can be accessed or are visible to the user from the keypad of the system. In addition, certain communicator reports are enabled in this location. Each of these features can be enabled by partition. This location contains 5 segments, with eight possible features per segment. Refer to Location 23 (page 18) for the feature selections. **If all segments are blank (nothing enabled), the features for partition 1 will be used.**

LOCATION 97 - PARTITION 4 ENTRY EXIT TIMERS (6 segments, numerical data)

Location 97 is used to enter in seconds the Entry and exit times. There are 2 separate entry and exit times. Valid entries are 10-255 seconds. **If all segments are "0", the entry and exit times for partition 1 will be used.**

Segment 1, Entry time 1: Entry time that will be used when a Delay 1 zone type initiates an entry delay.

Segment 2, Exit time 1: Exit time that will be used for all zones designated as Delay 1.

Segment 3, Entry time 2: Entry time that will be used when a Delay 2 zone type initiates an entry delay.

Segment 4, Exit time 2: Exit time that will be used for all zones designated as Delay 2.

Segments 5 & 6: Reserved

LOCATION 98 - ACCOUNT CODE FOR PARTITION 5 (6 segments, numerical data)

The account code sent when partition 5 is reported is programmed in location 98. **If location 98 is left unprogrammed (all "10") then the account code corresponding to the Phone number dialed will be used.** If the account code is less than six digits, program a "10" in the segment immediately after the last digit of the account code. If the account code is 6 digits long, program all 6 segments.

LOCATION 99 - PARTITION 5 FEATURE AND REPORTING SELECTIONS (5 SEGMENTS, NUMERICAL DATA)

Location 99 is used to enable certain features that can be accessed or are visible to the user from the keypad of the system. In addition, certain communicator reports are enabled in this location. Each of these features can be enabled by partition. This location contains 5 segments, with eight possible features per segment. Refer to Location 23 (page 18) for the feature selections. **If all segments are blank (nothing enabled), the features for partition 1 will be used.**

LOCATION 100 - PARTITION 5 ENTRY EXIT TIMERS (6 segments, numerical data)

Location 100 is used to enter in seconds the Entry and exit times. There are 2 separate entry and exit times. Valid entries are 10-255 seconds. **If all segments are "0", the entry and exit times for partition 1 will be used.**

Segment 1, Entry Time 1: Entry time that will be used when a delay 1 zone type initiates an entry delay.

Segment 2, Exit Time 1: Exit time that will be used for all zones designated as delay 1.

Segment 3, Entry Time 2: Entry time that will be used when a delay 2zone type initiates an entry delay.

Segment 4, Exit Time 2: Exit time that will be used for all zones designated as delay 2.

Segments 5 & 6: Reserved

LOCATION 101 - ACCOUNT CODE FOR PARTITION 6 (6 segments, numerical data)

The account code sent when partition 6 is reported is programmed in location 101. **If location 101 is left unprogrammed (all "10") then the account code corresponding to the Phone number dialed will be used.** Program the account code is less than six digits, program a "10" in the segment immediately after the last digit of the account code. If the account code is 6 digits long, program all 6 segments.

LOCATION 102 - PARTITION 6 FEATURE AND REPORTING SELECTIONS (5 segments, feature selection data)

Location 102 is used to enable certain features that can be accessed or are visible to the user from the keypad of the system. In addition, certain communicator reports are enabled in this location. Each of these features can be enabled by partition. This location contains 5 segments, with eight possible features per segment. Refer to Location 23 (page 18) for the feature selections. **If all segments are blank (nothing enabled), the features for partition 1 will be used.**

LOCATION 103 - PARTITION 6 ENTRY EXIT TIMERS (6 segments, numerical data)

Location 103 is used to enter in seconds the Entry and Exit times. There are 2 separate entry and exit times. Valid entries are 10-255 seconds. **If all segments are "0", the entry and exit times for partition 1 will be used.**

- Segment 1, Entry Time 1:** Entry time that will be used when a Delay 1 zone type initiates an entry delay.
- Segment 2, Exit Time 1:** Exit time that will be used for all zones designated as Delay 1.
- Segment 3, Entry Time 2:** Entry time that will be used when a Delay 2 zone type initiates an entry delay.
- Segment 4, Exit Time 2:** Exit time that will be used for all zones designated as Delay 2.
- Segments 5 & 6:** Reserved

LOCATION 104 - ACCOUNT CODE FOR PARTITION 7 (6 segments, numerical data)

The account code sent when partition 7 is reported is programmed in location 104. **If location 104 is left unprogrammed (all "10") then the account code corresponding to the Phone number dialed will be used.** If the account code is less than six digits, program a "10" in the segment immediately after the last digit of the account code. If the account code is 6 digits long, program all 6 segments.

LOCATION 105 - PARTITION 7 FEATURE AND REPORTING SELECTIONS (5 segments, feature selection data)

Location 105 is used to enable certain features that can be accessed or are visible to the user from the keypad of the system. In addition, certain communicator reports are enabled in this location. Each of these features can be enabled by partition. This location contains 5 segments, with eight possible features per segment. Refer to Location 23 (page 18) for the feature selections. **If all segments are blank (nothing enabled), the features for partition 1 will be used.**

LOCATION 106 - PARTITION 7 ENTRY EXIT TIMERS (6 segments, numerical data)

Location 106 is used to enter in seconds the Entry and Exit times. There are 2 separate entry and exit times. Valid entries are 10-255 seconds. **If all segments are "0", the entry and exit times for partition 1 will be used.**

- Segment 1, Entry Time 1:** Entry time that will be used when a Delay 1 zone type initiates an entry delay.
- Segment 2, Exit Time 1:** Exit time that will be used for all zones designated as Delay 1.
- Segment 3, Entry Time 2:** Entry time that will be used when a Delay 2 zone type initiates an entry delay.
- Segment 4, Exit Time 2:** Exit time that will be used for all zones designated as Delay 2.
- Segments 5 & 6:** Reserved

LOCATION 107 - ACCOUNT CODE FOR PARTITION 8 (6 segments, numerical data)

The account code sent when partition 8 is reported is programmed in location 107. **If location 107 is left unprogrammed (all "10") then the account code corresponding to the Phone number dialed will be used.** If the account code is less than six digits, program a "10" in the segment immediately after the last digit of the account code. If the account code is 6 digits long, program all 6 segments.

LOCATION 108 - PARTITION 8 FEATURE AND REPORTING SELECTIONS (5 segments, feature selection data)

Location 108 is used to enable certain features that can be accessed or are visible to the user from the keypad of the system. In addition, certain communicator reports are enabled in this location. Each of these features can be enabled by partition. This location contains 5 segments, with eight possible features per segment. Refer to Location 23 (page 18) for the feature selections. **If all segments are blank (nothing enabled), the features for partition 1 will be used.**

LOCATION 109 - PARTITION 8 ENTRY EXIT TIMERS (6 segments, numerical data)

Location 109 is used to enter in seconds the Entry and Exit times. There are 2 separate entry and exit times. Valid entries are 10-255 seconds. **If all segments are "0", the entry and exit times for partition 1 will be used.**

- Segment 1, Entry Time 1:** Entry time that will be used when a Delay 1 zone type initiates an entry delay.
- Segment 2, Exit Time 1:** Exit time that will be used for all zones designated as Delay 1.
- Segment 3, Entry Time 2:** Entry time that will be used when a Delay 2 zone type initiates an entry Delay.
- Segment 4, Exit Time 2:** Exit time that will be used for all zones designated as Delay 2.
- Segments 5 & 6:** Reserved

LOCATIONS 110-169 ARE USED TO CHANGE THE ZONE TYPES (Configurations) AS LISTED IN THE TABLE ON PAGE 19. THESE LOCATIONS ARE CONSIDERED ADVANCED PROGRAMMING AND SHOULD ONLY BE CHANGED WITH A THOROUGH UNDERSTANDING OF THE OPERATION OF EACH BIT.

LOCATION 110 - ZONE TYPE 1 ALARM EVENT CODE (1 segment, numerical data)

Location 110 contains the event code sent for a Contact ID or SIA report. The desired event code should be chosen from the list on page 70. The zone ID will be that zone that is in alarm.

4+2 Format Note: If 4+2 format is being used, the number programmed in this location will be sent as the upper hex digit. The digit in location 110 should be from 1 to 15 when using 4+2 formats. The zone ID or user ID will be the lower hex digit of the zone that is in alarm.

LOCATION 111 - ZONE TYPE 1 CHARACTERISTIC SELECT (5 segments, feature selection data)

- Segment 1:**
- 1 = Fire (turn on if this is a fire zone).
 - 2 = 24 hour (turn on for non-fire 24 hour zones).
 - 3 = Keyswitch zone. (normally open switch)
 - 4 = Follower (turn on for burglary zones that are Instant during non-entry times).
 - 5 = Delay 1 zone (follows timer 1 entry and exit times).
 - 6 = Delay 2 zone (follows timer 2 entry and exit times).
 - 7 = Interior (turn on if this zone should Automatically Bypass or Bypass for Stay Arming).
 - 8 = Local only (turn on if this zone should not be reported).
- Segment 2:**
- 1 = On if Zone Type will beep the keypad for alarm.
 - 2 = On if Zone Type will sound the yelping siren for alarm.
 - 3 = On if Zone Type will sound the temporal siren for alarm.
 - 4 = On if Zone Type will chime.
 - 5 = On if Zone Type can be bypassed.
 - 6 = On if Zone Type is included in the group shunt.
 - 7 = On if Zone Type is force armable.
 - 8 = On if Zone Type is entry guard.
- Segment 3:**
- 1 = On enables Fast Loop Response. (50mS)- Off= 500mS
 - 2 = On enables Double End Of Line Tamper zone. (Mainly used for tamper on wireless zones)
 - 3 = On enables Trouble Reporting zone. (Day zone and Fire zones)
 - 4 = On if Zone Type is a Cross Zone.
 - 5 = On enables Dialer Delay zone. (See location 40, page 23)
 - 6 = On if Zone Type will swinger shutdown. (See location 38, page 23)
 - 7 = On enables Restore reporting.
 - 8 = On enables Listen-In. (See location 40, page 23)
- Segment 4:**
- 1 = On enables Zone Activity Monitor. (See location 40, page 23)
 - 2 = On enables End of Line Resistor Defeat on Non-Fire/Non-Keyswitch zones.
 - 3 = On enables zone to act as *request to exit* input / disables for alarm activation.
 - 4 = On enables zone to act as an access control input. (Do not enable unless configured with Access Control.)
 - 5-8 = Reserved.
- Segment 5:** Reserved.

LOCATION 112 - ZONE TYPE 2 ALARM EVENT CODE (1 segment, numerical data)

Location 112 contains the event code sent for a Contact ID or SIA report. The desired event code should be chosen from the list on page 70. The zone ID will be that zone that is in alarm. If 4+2 format is being used, refer to Location 110 on page 33 for details.

LOCATION 113 - ZONE TYPE 2 CHARACTERISTIC SELECT (5 segments, feature selection data)

Use "Zone Type Characteristic Selections" described in Location 111, page 33.

LOCATION 114 - ZONE TYPE 3 ALARM EVENT CODE (1 segment, numerical data)

Location 114 contains the event code sent for a Contact ID or SIA report. The desired event code should be chosen from the list on page 70. The zone ID will be that zone that is in alarm. If 4+2 format is being used, refer to Location 110 on page 33 for details.

LOCATION 115 - ZONE TYPE 3 CHARACTERISTIC SELECT (5 segments, feature selection data)

Use "Zone Type Characteristic Selections" described in Location 111, page 33.

LOCATION 116 - ZONE TYPE 4 ALARM EVENT CODE (1 segment, numerical data)

Location 116 contains the event code sent for a Contact ID or SIA report. The desired event code should be chosen from the list on page 70. The zone ID will be that zone that is in alarm. If 4+2 format is being used, refer to Location 110 on page 33 for details.

LOCATION 117 - ZONE TYPE 4 CHARACTERISTIC SELECT (5 segments, feature selection data)

Use "Zone Type Characteristic Selections" described in Location 111, page 33.

LOCATION 118 - ZONE TYPE 5 ALARM EVENT CODE (1 segment, numerical data)

Location 118 contains the event code sent for a Contact ID or SIA report. The desired event code should be chosen from the list on page 70. The zone ID will be that zone that is in alarm. If 4+2 format is being used, refer to Location 110 on page 33 for details.

LOCATION 119 - ZONE TYPE 5 CHARACTERISTIC SELECT (5 segments, feature selection data)

Use "Zone Type Characteristic Selections" described in Location 111, page 33.

LOCATION 120 - ZONE TYPE 6 ALARM EVENT CODE (1 segment, numerical data)

Location 120 contains the event code sent for a Contact ID or SIA report. The desired event code should be chosen from the list on page 70. The zone ID will be that zone that is in alarm. If 4+2 format is being used, refer to Location 110 on page 33 for details.

LOCATION 121 - ZONE TYPE 6 CHARACTERISTIC SELECT (5 segments, feature selection data)

Use "Zone Type Characteristic Selections" described in Location 111, page 33.

LOCATION 122 - ZONE TYPE 7 ALARM EVENT CODE (1 segment, numerical data)

Location 122 contains the event code sent for a Contact ID or SIA report. The desired event code should be chosen from the list on page 70. The zone ID will be that zone that is in alarm. If 4+2 format is being used, refer to Location 110 on page 33 for details.

LOCATION 123 - ZONE TYPE 7 CHARACTERISTIC SELECT (5 segments, feature selection data)

Use "Zone Type Characteristic Selections" described in Location 111, page 33.

LOCATION 124 - ZONE TYPE 8 ALARM EVENT CODE (1 segment, numerical data)

Location 124 contains the event code sent for a Contact ID or SIA report. The desired event code should be chosen from the list on page 70. The zone ID will be that zone that is in alarm. If 4+2 format is being used, refer to Location 110 on page 33 for details.

LOCATION 125 - ZONE TYPE 8 CHARACTERISTIC SELECT (5 segments, feature selection data)

Use "Zone Type Characteristic Selections" described in Location 111, page 33.

LOCATION 126 - ZONE TYPE 9 ALARM EVENT CODE (1 segment, numerical data)

Location 126 contains the event code sent for a Contact ID or SIA report. The desired event code should be chosen from the list on page 70. The zone ID will be that zone that is in alarm. If 4+2 format is being used, refer to Location 110 on page 33 for details.

LOCATION 127 - ZONE TYPE 9 CHARACTERISTIC SELECT (5 segments, feature selection data)

Use "Zone Type Characteristic Selections" described in Location 111, page 33.

LOCATION 128 - ZONE TYPE 10 ALARM EVENT CODE (1 segment, numerical data)

Location 128 contains the event code sent for a Contact ID or SIA report. The desired event code should be chosen from the list on page 70. The zone ID will be that zone that is in alarm. If 4+2 format is being used, refer to Location 110 on page 33 for details.

LOCATION 129 - ZONE TYPE 10 CHARACTERISTIC SELECT (5 segments, feature selection data)

Use "Zone Type Characteristic Selections" described in Location 111, page 33.

LOCATION 130 - ZONE TYPE 11 ALARM EVENT CODE (1 segment, numerical data)

Location 130 contains the event code sent for a Contact ID or SIA report. The desired event code should be chosen from the list on page 70. The zone ID will be that zone that is in alarm. If 4+2 format is being used, refer to Location 110 on page 33 for details.

LOCATION 131 - ZONE TYPE 11 CHARACTERISTIC SELECT (5 segments, feature selection data)

Use "Zone Type Characteristic Selections" described in Location 111, page 33.

LOCATION 132 - ZONE TYPE 12 ALARM EVENT CODE (1 segment, numerical data)

Location 132 contains the event code sent for a Contact ID or SIA report. The desired event code should be chosen from the list on page 70. The zone ID will be that zone that is in alarm. If 4+2 format is being used, refer to Location 110 on page 33 for details.

LOCATION 133 - ZONE TYPE 12 CHARACTERISTIC SELECT (5 segments, feature selection data)

Use "Zone Type Characteristic Selections" described in Location 111, page 33.

LOCATION 134 - ZONE TYPE 13 ALARM EVENT CODE (1 segment, numerical data)

Location 134 contains the event code sent for a Contact ID or SIA report. The desired event code should be chosen from the list on page 70. The zone ID will be that zone that is in alarm. If 4+2 format is being used, refer to Location 110 on page 33 for details.

LOCATION 135 - ZONE TYPE 13 CHARACTERISTIC SELECT (5 segments, feature selection data)

Use "Zone Type Characteristic Selections" described in Location 111, page 33.

LOCATION 136 - ZONE TYPE 14 ALARM EVENT CODE (1 segment, numerical data)

Location 136 contains the event code sent for a Contact ID or SIA report. The desired event code should be chosen from the list on page 70. The zone ID will be that zone that is in alarm. If 4+2 format is being used, refer to Location 110 on page 33 for details.

LOCATION 137 - ZONE TYPE 14 CHARACTERISTIC SELECT (5 segments, feature selection data)

Use "Zone Type Characteristic Selections" described in Location 111, page 33.

LOCATION 138 - ZONE TYPE 15 ALARM EVENT CODE (1 segment, numerical data)

Location 138 contains the event code sent for a Contact ID or SIA report. The desired event code should be chosen from the list on page 70. The zone ID will be that zone that is in alarm. If 4+2 format is being used, refer to Location 110 on page 33 for details.

LOCATION 139 - ZONE TYPE 15 CHARACTERISTIC SELECT (5 segments, feature selection data)

Use "Zone Type Characteristic Selections" described in Location 111, page 33.

LOCATION 140 - ZONE TYPE 16 ALARM EVENT CODE (1 segment, numerical data)

Location 140 contains the event code sent for a Contact ID or SIA report. The desired event code should be chosen from the list on page 70. The zone ID will be that zone that is in alarm. If 4+2 format is being used, refer to Location 110 on page 33 for details.

LOCATION 141 - ZONE TYPE 16 CHARACTERISTIC SELECT (5 segments, feature selection data)

Use "Zone Type Characteristic Selections" described in Location 111, page 33.

LOCATION 142 - ZONE TYPE 17 ALARM EVENT CODE (1 segment, numerical data)

Location 142 contains the event code sent for a Contact ID or SIA report. The desired event code should be chosen from the list on page 70. The zone ID will be that zone that is in alarm. If 4+2 format is being used, refer to Location 110 on page 33 for details.

LOCATION 143 - ZONE TYPE 17 CHARACTERISTIC SELECT (5 segments, feature selection data)

Use "Zone Type Characteristic Selections" described in Location 111, page 33.

LOCATION 144 - ZONE TYPE 18 ALARM EVENT CODE (1 segment, numerical data)

Location 144 contains the event code sent for a Contact ID or SIA report. The desired event code should be chosen from the list on page 70. The zone ID will be that zone that is in alarm. If 4+2 format is being used, refer to Location 110 on page 33 for details.

LOCATION 145 - ZONE TYPE 18 CHARACTERISTIC SELECT (5 segments, feature selection data)

Use "Zone Type Characteristic Selections" described in Location 111, page 33.

LOCATION 146 - ZONE TYPE 19 ALARM EVENT CODE (1 segment, numerical data)

Location 146 contains the event code sent for a Contact ID or SIA report. The desired event code should be chosen from the list on page 70. The zone ID will be that zone that is in alarm. If 4+2 format is being used, refer to Location 110 on page 33 for details.

LOCATION 147 - ZONE TYPE 19 CHARACTERISTIC SELECT (5 segments, feature selection data)

Use "Zone Type Characteristic Selections" described in Location 111, page 33.

LOCATION 148 - ZONE TYPE 20 ALARM EVENT CODE (1 segment, numerical data)

Location 148 contains the event code sent for a Contact ID or SIA report. The desired event code should be chosen from the list on page 70. The zone ID will be that zone that is in alarm. If 4+2 format is being used, refer to Location 110 on page 33 for details.

LOCATION 149 - ZONE TYPE 20 CHARACTERISTIC SELECT (5 segments, feature selection data)

Use "Zone Type Characteristic Selections" described in Location 111, page 33.

LOCATION 150 - ZONE TYPE 21 ALARM EVENT CODE (1 segment, numerical data)

Location 150 contains the event code sent for a Contact ID or SIA report. The desired event code should be chosen from the list on page 70. The zone ID will be that zone that is in alarm. If 4+2 format is being used, refer to Location 110 on page 33 for details.

LOCATION 151 - ZONE TYPE 21 CHARACTERISTIC SELECT (5 segments, feature selection data)

Use "Zone Type Characteristic Selections" described in Location 111, page 33.

LOCATION 152 - ZONE TYPE 22 ALARM EVENT CODE (1 segment, numerical data)

Location 152 contains the event code sent for a Contact ID or SIA report. The desired event code should be chosen from the list on page 70. The zone ID will be that zone that is in alarm. If 4+2 format is being used, refer to Location 110 on page 33 for details.

LOCATION 153 - ZONE TYPE 22 CHARACTERISTIC SELECT (5 segments, feature selection data)

Use "Zone Type Characteristic Selections" described in Location 111, page 33.

LOCATION 154 - ZONE TYPE 23 ALARM EVENT CODE (1 segment, numerical data)

Location 154 contains the event code sent for a Contact ID or SIA report. The desired event code should be chosen from the list on page 70. The zone ID will be that zone that is in alarm. If 4+2 format is being used, refer to Location 110 on page 33 for details.

LOCATION 155 - ZONE TYPE 23 CHARACTERISTIC SELECT (5 segments, feature selection data)

Use "Zone Type Characteristic Selections" described in Location 111, page 33.

LOCATION 156 - ZONE TYPE 24 ALARM EVENT CODE (1 segment, numerical data)

Location 156 contains the event code sent for a Contact ID or SIA report. The desired event code should be chosen from the list on page 70. The zone ID will be that zone that is in alarm. If 4+2 format is being used, refer to Location 110 on page 33 for details.

LOCATION 157 - ZONE TYPE 24 CHARACTERISTIC SELECT (5 segments, feature selection data)

Use "Zone Type Characteristic Selections" described in Location 111, page 33.

LOCATION 158 - ZONE TYPE 25 ALARM EVENT CODE (1 segment, numerical data)

Location 158 contains the event code sent for a Contact ID or SIA report. The desired event code should be chosen from the list on page 70. The zone ID will be that zone that is in alarm. If 4+2 format is being used, refer to Location 110 on page 33 for details.

LOCATION 159 - ZONE TYPE 25 CHARACTERISTIC SELECT (5 segments, feature selection data)

Use "Zone Type Characteristic Selections" described in Location 111, page 33.

LOCATION 160 - ZONE TYPE 26 ALARM EVENT CODE (1 segment, numerical data)

Location 160 contains the event code sent for a Contact ID or SIA report. The desired event code should be chosen from the list on page 70. The zone ID will be that zone that is in alarm. If 4+2 format is being used, refer to Location 110 on page 33 for details.

LOCATION 161 - ZONE TYPE 26 CHARACTERISTIC SELECT (5 segments, feature selection data)

Use "Zone Type Characteristic Selections" described in Location 111, page 33.

LOCATION 162 - ZONE TYPE 27 ALARM EVENT CODE (1 segment, numerical data)

Location 162 contains the event code sent for a Contact ID or SIA report. The desired event code should be chosen from the list on page 70. The zone ID will be that zone that is in alarm. If 4+2 format is being used, refer to Location 110 on page 33 for details.

LOCATION 163 - ZONE TYPE 27 CHARACTERISTIC SELECT (5 segments, feature selection data)

Use "Zone Type Characteristic Selections" described in Location 111, page 33.

LOCATION 164 - ZONE TYPE 28 ALARM EVENT CODE (1 segment, numerical data)

Location 164 contains the event code sent for a Contact ID or SIA report. The desired event code should be chosen from the list on page 70. The zone ID will be that zone that is in alarm. If 4+2 format is being used, refer to Location 110 on page 33 for details.

LOCATION 165 - ZONE TYPE 28 CHARACTERISTIC SELECT (5 segments, feature selection data)

Use "Zone Type Characteristic Selections" described in Location 111, page 33.

LOCATION 166 - ZONE TYPE 29 ALARM EVENT CODE (1 segment, numerical data)

Location 166 contains the event code sent for a Contact ID or SIA report. The desired event code should be chosen from the list on page 70. The zone ID will be that zone that is in alarm. If 4+2 format is being used, refer to Location 110 on page 33 for details.

LOCATION 167 - ZONE TYPE 29 CHARACTERISTIC SELECT (5 segments, feature selection data)

Use "Zone Type Characteristic Selections" described in Location 111, page 33.

LOCATION 168 - ZONE TYPE 30 ALARM EVENT CODE (1 segment, numerical data)

Location 168 contains the event code sent for a Contact ID or SIA report. The desired event code should be chosen from the list on page 70. The zone ID will be that zone that is in alarm. If 4+2 format is being used, refer to Location 110 on page 33 for details.

LOCATION 169 - ZONE TYPE 30 CHARACTERISTIC SELECT (5 segments, feature selection data)

Use "Zone Type Characteristic Selections" described in Location 111, page 33.

 **LOCATION 170 - ZONES 49-56 ZONE TYPE (8 segments, numerical data)**

Location 170 contains the Zone Type for zones 49 - 56. Segment 1 is for zone 49; Segment 8 is for zone 56. Default Zone Types are found in the table on page 19. To customize a Zone Type, see page 33.

LOCATION 171 - PARTITION SELECT, ZONES 49-56 (8 segments of feature selection data)

Location 171 is used to select the partition(s) that zones 49-56 reside in. A zone may reside in any combination of the 8 partitions. **If a burglary zone resides in more than 1 partition, it will only be active when all partitions are armed. A zone that resides in more than 1 partition will be reported to its lowest partition.** Segment 1 corresponds to zone 49 and Segment 8 corresponds to zone 56.

Segments 1 - 8:

1 = Partition #1	3 = Partition #3	5 = Partition #5	7 = Partition #7
2 = Partition #2	4 = Partition #4	6 = Partition #6	8 = Partition #8

 **LOCATION 172 - ZONES 57-64 ZONE TYPE (8 segments, numerical data)**

Location 172 contains the Zone Type for zones 57-64. Segment 1 is for zone 57; Segment 8 is for zone 64. Default Zone Types are found in the table on page 19. To customize a Zone Type, see page 33.

LOCATION 173 - PARTITION SELECT, ZONES 57-64 (8 segments of feature selection data)

Location 173 is used to select the partition(s) that zones 57-64 reside in. A zone may reside in any combination of the 8 partitions. **If a burglary zone resides in more than 1 partition, it will only be active when all partitions are armed. A zone that resides in more than 1 partition will be reported to its lowest partition.** Segment 1 corresponds to zone 57 and Segment 8 corresponds to zone 64.

Segments 1 - 8:

- | | | | |
|------------------|------------------|------------------|------------------|
| 1 = Partition #1 | 3 = Partition #3 | 5 = Partition #5 | 7 = Partition #7 |
| 2 = Partition #2 | 4 = Partition #4 | 6 = Partition #6 | 8 = Partition #8 |

 **LOCATION 174 - ZONES 65-72 ZONE TYPE (8 segments, numerical data)**

Location 174 contains the Zone Type for zones 65 - 72. Segment 1 is for zone 65; Segment 8 is for zone 72. Default Zone Types are found in the table on page 19. To customize a Zone Type, see page 33.

LOCATION 175 - PARTITION SELECT, ZONES 65-72 (8 segments of feature selection data)

Location 175 is used to select the partition(s) that zones 65-72 reside in. A zone may reside in any combination of the 8 partitions. **If a burglary zone resides in more than 1 partition, it will only be active when all partitions are armed. A zone that resides in more than 1 partition will be reported to its lowest partition.** Segment 1 corresponds to zone 65 and Segment 8 corresponds to zone 72.

Segments 1 - 8:

- | | | | |
|------------------|------------------|------------------|------------------|
| 1 = Partition #1 | 3 = Partition #3 | 5 = Partition #5 | 7 = Partition #7 |
| 2 = Partition #2 | 4 = Partition #4 | 6 = Partition #6 | 8 = Partition #8 |

 **LOCATION 176 - ZONES 73-80 ZONE TYPE (8 segments, numerical data)**

Location 176 contains the Zone Type for zones 73-80. Segment 1 is for zone 73; Segment 8 is for zone 80. Default Zone Types are found in the table on page 19. To customize a Zone Type, see page 33.

LOCATION 177 - PARTITION SELECT, ZONES 73-80 (8 segments of feature selection data)

Location 177 is used to select the partition(s) that zones 73-80 reside in. A zone may reside in any combination of the 8 partitions. **If a burglary zone resides in more than 1 partition, it will only be active when all partitions are armed. A zone that resides in more than 1 partition will be reported to its lowest partition.** Segment 1 corresponds to zone 73 and Segment 8 corresponds to zone 80.

Segments 1 - 8:

- | | | | |
|------------------|------------------|------------------|------------------|
| 1 = Partition #1 | 3 = Partition #3 | 5 = Partition #5 | 7 = Partition #7 |
| 2 = Partition #2 | 4 = Partition #4 | 6 = Partition #6 | 8 = Partition #8 |

 **LOCATION 178 - ZONES 81-88 ZONE TYPE (8 segments, numerical data)**

Location 178 contains the Zone Type for zones 81-88. Segment 1 is for zone 81; Segment 8 is for zone 88. Default Zone Types are found in the table on page 19. To customize a Zone Type, see page 33.

LOCATION 179 - PARTITION SELECT, ZONES 81-88 (8 segments of feature selection data)

Location 179 is used to select the partition(s) that zones 81 - 88 reside in. A zone may reside in any combination of the 8 partitions. **If a burglary zone resides in more than 1 partition, it will only be active when all partitions are armed. A zone that resides in more than 1 partition will be reported to its lowest partition.** Segment 1 corresponds to zone 81 and Segment 8 corresponds to zone 88.

Segments 1 - 8:

- | | | | |
|------------------|------------------|------------------|------------------|
| 1 = Partition #1 | 3 = Partition #3 | 5 = Partition #5 | 7 = Partition #7 |
| 2 = Partition #2 | 4 = Partition #4 | 6 = Partition #6 | 8 = Partition #8 |

 **LOCATION 180 - ZONES 89-96 ZONE TYPE (8 segments, numerical data)**

Location 180 contains the Zone Type for zones 89 - 96. Segment 1 is for zone 89; Segment 8 is for zone 96. Default Zone Types are found in the table on page 19. To customize a Zone Type, see page 33.

LOCATION 181 - PARTITION SELECT, ZONES 89-96 (8 segments of feature selection data)

Location 181 is used to select the partition(s) that zones 89 - 96 reside in. A zone may reside in any combination of the 8 partitions. **If a burglary zone resides in more than 1 partition, it will only be active when all partitions are armed. A zone that resides in more than 1 partition will be reported to its lowest partition.** Segment 1 corresponds to zone 89 and Segment 8 corresponds to zone 96.

Segments 1 - 8:

- | | | | |
|------------------|------------------|------------------|------------------|
| 1 = Partition #1 | 3 = Partition #3 | 5 = Partition #5 | 7 = Partition #7 |
| 2 = Partition #2 | 4 = Partition #4 | 6 = Partition #6 | 8 = Partition #8 |

 **LOCATION 182 - ZONES 97-104 ZONE TYPE (8 segments, numerical data)**

Location 182 contains the Zone Type for zones 97-104. Segment 1 is for zone 97; Segment 8 is for zone 104. Default Zone Types are found in the table on page 19. To customize a Zone Type, see page 33.

LOCATION 183 - PARTITION SELECT, ZONES 97-104 (8 segments of feature selection data)

Location 183 is used to select the partition(s) that zones 97-104 reside in. A zone may reside in any combination of the 8 partitions. **If a burglary zone resides in more than 1 partition, it will only be active when all partitions are armed. A zone that resides in more than 1 partition will be reported to its lowest partition.** Segment 1 corresponds to zone 97 and Segment 8 corresponds to zone 104.

Segments 1 - 8:

- | | | | |
|------------------|------------------|------------------|------------------|
| 1 = Partition #1 | 3 = Partition #3 | 5 = Partition #5 | 7 = Partition #7 |
| 2 = Partition #2 | 4 = Partition #4 | 6 = Partition #6 | 8 = Partition #8 |

 **LOCATION 184 - ZONES 105-112 ZONE TYPE (8 segments, numerical data)**

Location 184 contains the Zone Type for zones 105-112. Segment 1 is for zone 105; Segment 8 is for zone 112. Default Zone Types are found in the table on page 19. To customize a Zone Type, see page 33.

LOCATION 185 - PARTITION SELECT, ZONES 105-112 (8 segments of feature selection data)

Location 185 is used to select the partition(s) that zones 105-112 reside in. A zone may reside in any combination of the 8 partitions. **If a burglary zone resides in more than 1 partition, it will only be active when all partitions are armed. A zone that resides in more than 1 partition will be reported to its lowest partition.** Segment 1 corresponds to zone 105 and Segment 8 corresponds to zone 112.

Segments 1 - 8:

- | | | | |
|------------------|------------------|------------------|------------------|
| 1 = Partition #1 | 3 = Partition #3 | 5 = Partition #5 | 7 = Partition #7 |
| 2 = Partition #2 | 4 = Partition #4 | 6 = Partition #6 | 8 = Partition #8 |

 **LOCATION 186 - ZONES 113-120 ZONE TYPE (8 segments, numerical data)**

Location 186 contains the Zone Type for zones 113-120. Segment 1 is for zone 113; Segment 8 is for zone 120. Default Zone Types are found in the table on page 19. To customize a Zone Type, see page 33.

LOCATION 187 - PARTITION SELECT, ZONES 113-120 (8 segments of feature selection data)

Location 187 is used to select the partition(s) that zones 113-120 reside in. A zone may reside in any combination of the 8 partitions. **If a burglary zone resides in more than 1 partition, it will only be active when all partitions are armed. A zone that resides in more than 1 partition will be reported to its lowest partition.** Segment 1 corresponds to zone 113 and Segment 8 corresponds to zone 120.

Segments 1 - 8:

- | | | | |
|------------------|------------------|------------------|------------------|
| 1 = Partition #1 | 3 = Partition #3 | 5 = Partition #5 | 7 = Partition #7 |
| 2 = Partition #2 | 4 = Partition #4 | 6 = Partition #6 | 8 = Partition #8 |

 **LOCATION 188 - ZONES 121-128 ZONE TYPE (8 segments, numerical data)**

Location 188 contains the Zone Type for zones 121-128. Segment 1 is for zone 121; Segment 8 is for zone 128. Default Zone Types are found in the table on page 19. To customize a Zone Type, see page 33.

LOCATION 189 - PARTITION SELECT, ZONES 121-128 (8 segments of feature selection data)

Location 189 is used to select the partition(s) that zones 121-128 reside in. A zone may reside in any combination of the 8 partitions. **If a burglary zone resides in more than 1 partition, it will only be active when all partitions are armed. A zone that resides in more than 1 partition will be reported to its lowest partition.** Segment 1 corresponds to zone 121 and Segment 8 corresponds to zone 128.

Segments 1 - 8:

1 = Partition #1	3 = Partition #3	5 = Partition #5	7 = Partition #7
2 = Partition #2	4 = Partition #4	6 = Partition #6	8 = Partition #8

 **LOCATION 190 - ZONES 129-136 ZONE TYPE (8 segments, numerical data)**

Location 190 contains the Zone Type for zones 129-136. Segment 1 is for zone 129; Segment 8 is for zone 136. Default Zone Types are found in the table on page 19. To customize a Zone Type, see page 33.

LOCATION 191 - PARTITION SELECT, ZONES 129-136 (8 segments of feature selection data)

Location 191 is used to select the partition(s) that zones 129-136 reside in. A zone may reside in any combination of the 8 partitions. **If a burglary zone resides in more than 1 partition, it will only be active when all partitions are armed. A zone that resides in more than 1 partition will be reported to its lowest partition.** Segment 1 corresponds to zone 129 and Segment 8 corresponds to zone 136.

Segments 1 - 8:

1 = Partition #1	3 = Partition #3	5 = Partition #5	7 = Partition #7
2 = Partition #2	4 = Partition #4	6 = Partition #6	8 = Partition #8

 **LOCATION 192 - ZONES 137-144 ZONE TYPE (8 segments, numerical data)**

Location 192 contains the Zone Type for zones 137-144. Segment 1 is for zone 137; Segment 8 is for zone 144. Default Zone Types are found in the table on page 19. To customize a Zone Type, see page 33.

LOCATION 193 - PARTITION SELECT, ZONES 137-144 (8 segments of feature selection data)

Location 193 is used to select the partition(s) that zones 137-144 reside in. A zone may reside in any combination of the 8 partitions. **If a burglary zone resides in more than 1 partition, it will only be active when all partitions are armed. A zone that resides in more than 1 partition will be reported to its lowest partition.** Segment 1 corresponds to zone 137 and Segment 8 corresponds to zone 144.

Segments 1 - 8:

1 = Partition #1	3 = Partition #3	5 = Partition #5	7 = Partition #7
2 = Partition #2	4 = Partition #4	6 = Partition #6	8 = Partition #8

 **LOCATION 194 - ZONES 145-152 ZONE TYPE (8 segments, numerical data)**

Location 194 contains the Zone Type for zones 145-152. Segment 1 is for zone 145; Segment 8 is for zone 152. Default Zone Types are found in the table on page 19. To customize a Zone Type, see page 33.

LOCATION 195 - PARTITION SELECT, ZONES 145-152 (8 segments of feature selection data)

Location 195 is used to select the partition(s) that zones 145-152 reside in. A zone may reside in any combination of the 8 partitions. **If a burglary zone resides in more than 1 partition, it will only be active when all partitions are armed. A zone that resides in more than 1 partition will be reported to its lowest partition.** Segment 1 corresponds to zone 145 and Segment 8 corresponds to zone 152.

Segments 1 - 8:

1 = Partition #1	3 = Partition #3	5 = Partition #5	7 = Partition #7
2 = Partition #2	4 = Partition #4	6 = Partition #6	8 = Partition #8

 **LOCATION 196 - ZONES 153-160 ZONE TYPE (8 segments, numerical data)**

Location 196 contains the Zone Type for zones 153-160. Segment 1 is for zone 153; Segment 8 is for zone 160. Default Zone Types are found in the table on page 19. To customize a Zone Type, see page 33.

LOCATION 197 - PARTITION SELECT, ZONES 153-160 (8 segments of feature selection data)

Location 197 is used to select the partition(s) that zones 153-160 reside in. A zone may reside in any combination of the 8 partitions. **If a burglary zone resides in more than 1 partition, it will only be active when all partitions are armed. A zone that resides in more than 1 partition will be reported to its lowest partition.** Segment 1 corresponds to zone 153 and Segment 8 corresponds to zone 160.

Segments 1 - 8:

1 = Partition #1	3 = Partition #3	5 = Partition #5	7 = Partition #7
2 = Partition #2	4 = Partition #4	6 = Partition #6	8 = Partition #8

LOCATION 198 - ZONES 161-168 ZONE TYPE (8 segments, numerical data)

Location 198 contains the Zone Type for zones 161-168. Segment 1 is for zone 161; Segment 8 is for zone 168. Default Zone Types are found in the table on page 19. To customize a Zone Type, see page 33.

LOCATION 199 - PARTITION SELECT, ZONES 161-168 (8 segments of feature selection data)

Location 199 is used to select the partition(s) that zones 161-168 reside in. A zone may reside in any combination of the 8 partitions. **If a burglary zone resides in more than 1 partition, it will only be active when all partitions are armed. A zone that resides in more than 1 partition will be reported to its lowest partition.** Segment 1 corresponds to zone 161 and Segment 8 corresponds to zone 168.

Segments 1 - 8:

1 = Partition #1	3 = Partition #3	5 = Partition #5	7 = Partition #7
2 = Partition #2	4 = Partition #4	6 = Partition #6	8 = Partition #8

LOCATION 200 - ZONES 169-176 ZONE TYPE (8 segments, numerical data)

Location 200 contains the Zone Type for zones 169-176. Segment 1 is for zone 169; Segment 8 is for zone 176. Default Zone Types are found in the table on page 19. To customize a Zone Type, see page 33.

LOCATION 201 - PARTITION SELECT, ZONES 169-176 (8 segments of feature selection data)

Location 201 is used to select the partition(s) that zones 169-176 reside in. A zone may reside in any combination of the 8 partitions. **If a burglary zone resides in more than 1 partition, it will only be active when all partitions are armed. A zone that resides in more than 1 partition will be reported to its lowest partition.** Segment 1 corresponds to zone 169 and Segment 8 corresponds to zone 176.

Segments 1 - 8:

1 = Partition #1	3 = Partition #3	5 = Partition #5	7 = Partition #7
2 = Partition #2	4 = Partition #4	6 = Partition #6	8 = Partition #8

LOCATION 202 - ZONES 177-184 ZONE TYPE (8 segments, numerical data)

Location 202 contains the Zone Type for zones 177-184. Segment 1 is for zone 177; Segment 8 is for zone 184. Default Zone Types are found in the table on page 19. To customize a Zone Type, see page 33.

LOCATION 203 - PARTITION SELECT, ZONES 177-184 (8 segments of feature selection data)

Location 203 is used to select the partition(s) that zones 177-184 reside in. A zone may reside in any combination of the 8 partitions. **If a burglary zone resides in more than 1 partition, it will only be active when all partitions are armed. A zone that resides in more than 1 partition will be reported to its lowest partition.** Segment 1 corresponds to zone 177 and Segment 8 corresponds to zone 184.

Segments 1 - 8:

1 = Partition #1	3 = Partition #3	5 = Partition #5	7 = Partition #7
2 = Partition #2	4 = Partition #4	6 = Partition #6	8 = Partition #8

LOCATION 204 - ZONES 185-192 ZONE TYPE (8 segments, numerical data)

Location 204 contains the Zone Type for zones 185-192. Segment 1 is for zone 185; Segment 8 is for zone 192. Default Zone Types are found in the table on page 19. To customize a Zone Type, see page 33.

LOCATION 205 - PARTITION SELECT, ZONES 185-192 (8 segments of feature selection data)

Location 205 is used to select the partition(s) that zones 185-192 reside in. A zone may reside in any combination of the 8 partitions. **If a burglary zone resides in more than 1 partition, it will only be active when all partitions are armed. A zone that resides in more than 1 partition will be reported to its lowest partition.** Segment 1 corresponds to zone 185 and Segment 8 corresponds to zone 192.

Segments 1 - 8:

1 = Partition #1	3 = Partition #3	5 = Partition #5	7 = Partition #7
2 = Partition #2	4 = Partition #4	6 = Partition #6	8 = Partition #8

LOCATION 206 – AUTO DISARM DAY SELECTOR (8 segments of feature selection data)

Location 206 selects which days each partition will auto disarm. Segment 1 is for partition 1, and segment 8 is for partition 8. If a zone is faulted when the panel tries to auto disarm, the zone will be bypassed.

- Segments 1-8:**
- 1 - Auto Disarming on Sunday.
 - 2 - Auto Disarming on Monday.
 - 3 - Auto Disarming on Tuesday.
 - 4 - Auto Disarming on Wednesday.
 - 5 - Auto Disarming on Thursday.
 - 6 - Auto Disarming on Friday.
 - 7 - Auto Disarming on Saturday.
 - 8 - Reserved.

LOCATION 207 – SERIAL PORT SELECTOR (1 segment of feature selection data)

Location 206 enables the serial port operations. There is one segment

“0” = Disabled (Default) “1” = NX584 enabled “2” = Serial Printer Enabled.

LOCATION 208 – BAUD RATE TABLE (1 segment of numerical data)

The NX584 can operate on a number of different baud rates. Consult the home automation application information to determine the best baud rate for your application and program it in Location 208. The default is “2” – 9600 Baud or the serial printer baud rate.

0 = 2400 Baud (2.4K)	2 = 9600 Baud (9.6K)	4 = 38400 Baud (38.4K)
1 = 4800 Baud (4.8K)	3 = 19200 Baud (19.2K)	5-7 = Reserved

LOCATION 209 – PROGRAMMING THE NX-8E HOME AUTOMATION PROTOCOL (1 segment of numerical data)

The NX-8E home automation protocol can operate in one of two possible modes - binary or ASCII. Consult the home automation application information to determine the proper mode for your application and program it in Location 209.

- Option 1 **LED Off** = Binary (Default is OFF) **LED On** = ASCII
- Option 2 “On” if Serial Port supervised. (When enabled, the serial port expects to be polled at least once every 4 minutes. If it doesn't get polled within 4 minutes, then an Expander Trouble Module 177 will be logged.) Default is OFF.
- Options 3 – 8 ... Reserved

LOCATION 210 – ENABLING THE NX-8E TRANSITION-BASED BROADCASTS (2 segments of feature selection data)

The NX-8E can be programmed to automatically send information to the home automation system whenever there has been a change in this information. This is referred to as ‘transition-based broadcasting’. Which information packets use ‘transition-based broadcasting’ is dependent upon the application and the capabilities of the home automation system. Location 210 is used to enable and disable the appropriate transition based broadcasts. Consult the home automation application information and enable the appropriate transition based broadcasts in Location 210.

Segment 1:

DATA	ENABLES TRANSITION
1	Reserved
2	Interface Configuration at power-up / end of download / program mode
3-4	Reserved
5	Zone Status Message
6	Zones Snapshot Message
7	Partition Status Message
8	Partitions Snapshot Message

Segment 2:

DATA	ENABLES TRANSITION
1	System Status Message
2	X-10 Message Received
3	Log Event Message
4	Keypad Message Received
5 - 8	Reserved

LOCATION 211 - PROGRAMMING THE COMMAND/REQUEST ENABLES (4 segments of feature selection data)

The NX-8E has the ability to perform a variety of commands asked of it by the home automation system. For example, it is possible to allow arming and disarming of the security system, programming of the security system, or bypassing of zones by the home automation system. Location 211 is used to select which commands, if any you wish the home automation system to have access. Consult the home automation application information and enable the appropriate commands for your application. **CAUTION: IT IS IMPORTANT TO UNDERSTAND THE CAPABILITES OF THE HOME AUTOMATION SYSTEM TO AVOID COMPROMISING THE SECURITY OF YOUR SYSTEM WHEN PROGRAMMING THIS LOCATION.**

Segment 1:

DATA	SUPPORTED REQUEST / COMMAND
1	Reserved
2	Interface Configuration Request
3	Reserved
4	Zone Name Request
5	Zone Status Request
6	Zones Snapshot Request
7	Partition Status Request
8	Partitions Snapshot Request

Segment 2:

DATA	SUPPORTED REQUEST / COMMAND
1	System Status Request
2	Send X-10 Message
3	Log Event Request
4	Send Keypad Text Message
5	Keypad Terminal Mode Request
6 - 8	Reserved

Segment 3:

DATA	SUPPORTED REQUEST / COMMAND
1	Program Data Request
2	Program Data Command
3	User Information Request with PIN
4	User Information Request without PIN
5	Set User Code Command with PIN
6	Set User Code Command without PIN
7	Set User Authorization Command with PIN
8	Set User Authorization Command without PIN

Segment 4:

DATA	SUPPORTED REQUEST / COMMAND
1	Reserved
2	Reserved
3	Store Communication Event Command
4	Set Clock / Calendar Command
5	Primary Keypad Function with PIN
6	Primary Keypad Function without PIN
7	Secondary Keypad Function
8	Zone Bypass Toggle







LOCATION 212 - PROGRAMMING THE LCD KEYPAD ADDRESS (1 segment of numerical data)





Certain commands in the NX-8E require it to know the location of at least 1 LCD keypad (if one exists in the system). If your system has an LCD keypad it is recommended that it be placed in partition 1 keypad 1. This will allow location 212 to be left at the factory default. If the LCD keypad is selected as something other than partition 1/ keypad 1 program the appropriate address in location 212. Select the address from the following chart.

KEYPAD	PART 1	PART 2	PART 3	PART 4	PART 5	PART 6	PART 7	PART 8
1	192	193	194	195	196	197	198	199
2	200	201	202	203	204	205	206	207
3	208	209	210	211	212	213	214	215
4	216	217	218	219	220	221	222	223
5	224	225	226	227	228	229	230	231
6	232	233	234	235	236	237	238	239
7	240	241	242	243	244	245	246	247
8	248	249	250	251	252	253	254	255

XII. PROGRAMMING WORKSHEETS

(Factory defaults for segments are in ***bold italics*** text and "Quick Start" locations are identified with the  symbol.)

LOC	PG	DESCRIPTION	DEFAULT	PROGRAMMING DATA	
 0	13	PHONE #1	<i>14-14-14-14-14-14-14-14-14-14-14-14-14-14-14-14-14</i>	----- -----	
 1	13	PHONE #1, ACCOUNT CODE	<i>10 - 10 - 10 - 10 - 10 - 10</i>	-----	
 2	13	PHONE #1, REPORTING FORMAT	<i>0</i>	-	
 3	13	PHONE #1, DIAL ATTEMPTS BACKUP CONTROL	<i>8</i> <i>0</i>	- -	
4	14	PHONE #1, SELECTING EVENTS TO REPORT TO PHONE #1			
		Segment #1 (Circle Numbers To Program)	Segment #2 (Circle Numbers To Program)		
		<i>1 = Alarms and Restores</i> <i>2 = Open/Close</i> <i>3 = Bypass</i> <i>4 = Zone Trouble</i> <i>5 = Power Trouble (AC Failure or Low Battery)</i> <i>6 = Siren & Telephone Fault</i> <i>7 = Test Reports</i> <i>8 = Program, Download, & Log Full</i>	<i>1 = Tamper</i> <i>2 = Short Circuit & Ground Fault</i> <i>3 = Sensor Lost</i> <i>4 = Sensor Low Battery</i> <i>5 = Expander Trouble</i> <i>6 = Failure To Communicate</i> <i>7 = Zone Activity Monitor</i> <i>8 = Reserved</i>		
5	14	PHONE #1, SELECTING WHICH PARTITIONS REPORT TO PHONE #1			
		Segment #1 (Circle Numbers To Program)			
		1 = Partition #1 2 = Partition #2	3 = Partition #3 4 = Partition #4	5 = Partition #5 6 = Partition #6	7 = Partition #7 8 = Partition #8
 6	14	PHONE #2	<i>14-14-14-14-14-14-14-14-14-14-14-14-14-14-14-14-14</i>	----- -----	
 7	14	PHONE #2, ACCOUNT CODE	<i>10 - 10 - 10 - 10 - 10 - 10</i>	-----	
 8	15	PHONE #2, REPORTING FORMAT	<i>0</i>	-	
9	15	PHONE #2, DIAL ATTEMPTS BACKUP CONTROL	<i>8</i> <i>0</i>	- -	
10	15	PHONE #2, SELECTING EVENTS TO REPORT TO PHONE #2			
		Segment #1 (Circle Numbers To Program)	Segment #2 (Circle Numbers To Program)		
		<i>1 = Alarms and Restores</i> <i>2 = Open/Close</i> <i>3 = Bypass</i> <i>4 = Zone Trouble</i> <i>5 = Power Trouble (AC Failure or Low Battery)</i> <i>6 = Siren & Telephone Fault</i> <i>7 = Test Reports</i> <i>8 = Program, Download, & Log Full</i>	<i>1 = Tamper</i> <i>2 = Short Circuit & Ground Fault</i> <i>3 = Sensor Lost</i> <i>4 = Sensor Low Battery</i> <i>5 = Expander Trouble</i> <i>6 = Failure To Communicate</i> <i>7 = Zone Activity Monitor</i> <i>8 = Reserved</i>		
11	16	PHONE #2, SELECTING WHICH PARTITIONS REPORT TO PHONE #2			
		Segment #1 (Circle Numbers To Program)			
		1 = Partition #1 2 = Partition #2	3 = Partition #3 4 = Partition #4	5 = Partition #5 6 = Partition #6	7 = Partition #7 8 = Partition #8
12	16	PHONE #3	<i>14-14-14-14-14-14-14-14-14-14-14-14-14-14-14-14-14</i>	----- -----	
13	16	PHONE #3, ACCOUNT CODE	<i>10 - 10 - 10 - 10 - 10 - 10</i>	-----	

LOC	PG	DESCRIPTION	DEFAULT	PROGRAMMING DATA
14	16	PHONE #3, REPORTING FORMAT	0	—
15	16	PHONE #3, DIAL ATTEMPTS BACKUP CONTROL	8 0	— —
16	17	PHONE #3, SELECTING EVENTS TO REPORT TO PHONE #3		
		Segment #1 (Circle Numbers To Program)	Segment #2 (Circle Numbers To Program)	
		1 = Alarms and Restores	1 = Tamper	
		2 = Open/Close	2 = Short Circuit & Ground Fault	
		3 = Bypass	3 = Sensor Lost	
		4 = Zone Trouble	4 = Sensor Low Battery	
		5 = Power Trouble (AC Failure or Low Battery)	5 = Expander Trouble	
		6 = Siren & Telephone Fault	6 = Failure To Communicate	
		7 = Test Reports	7 = Zone Activity Monitor	
		8 = Program, Download, & Log Full	8 = Reserved	
17	17	PHONE #3, SELECTING WHICH PARTITIONS REPORT TO PHONE #3		
		Segment #1 (Circle Numbers To Program)		
		1 = Partition #1	3 = Partition #3	5 = Partition #5
		2 = Partition #2	4 = Partition #4	6 = Partition #6
			7 = Partition #7	8 = Partition #8
18	17	FORMAT OVERRIDE		
		Segment #1 (Circle Numbers To Program)	Segment #2 (Circle Numbers To Program)	
		1 = ON - 1800hz transmit; OFF - 1900hz	1 = ON - pager format (no handshake required)	
		2 = ON - 2300hz handshake; OFF - 1400hz.	2 = ON - 1400/2300 handshake	
		3 = ON - cksum parity; OFF - double round parity	3 = Reserved	
		4 = ON - 2 digit event code; OFF - 1 digit code	4 = Reserved	
		5 = Reserved.	5 = ON - Contact ID	
		6 = Reserved.	6 = ON - SIA	
		7 = ON - 20 p.p.s.; OFF - 10 or 40 p.p.s.	7 = ON - Contact ID or 4+3	
		8 = ON - 10 p.p.s.; OFF - 20 or 40 p.p.s.	8 = ON - DTMF	
		Segments #3 & #4 RESERVED		
 19	17	DOWNLOAD ACCESS CODE	8-4-8-0-0-0-0-0	— — — — —
 20	17	RINGS TO ANSWER DOWNLOAD	8	—
 21	18	DOWNLOAD CONTROL		
		Segment #1 (Circle Numbers To Program)		
		1 = Enables two call answering machine defeat		
		2 = Enables tone sniff answering machine defeat		
		3 = Requires callback before downloading		
		4 = Shutdown control panel		
		5 = Lock out local programming		
		6 = Lock out communicator programming		
		7 = Lock out download section		
		8 = Enables callback at autotest interval		
 22	18	CALLBACK PHONE NUMBER	14-14-14-14-14-14-14-14-14-14-14-14-14-14-14-14-14	— — — — — — — — — — — — — — —



LOC	PG	DESCRIPTION	DEFAULT	PROGRAMMING DATA						
☞ 23	18	PARTITION #1, FEATURE SELECTION								
		Segment #1								
		1 = Quick Arm 2 = Re-Exit 3 = Auto Bypass 4 = Silent Panic	5 = Audible Panic 6 = Auxiliary 1 7 = Auxiliary 2 8 = Multi Keypress Tamper							
		Segment #2								
		1 = LED extinguish enable 2 = Require user code for bypassing zones 3 = Bypass sounder alert 4 = AC power/low battery sounder alert	5 = Enables bypass toggle 6 = Enables silent auto arm 7 = Enables automatic instant 8 = Enables Instant Mode toggle							
		Segment #3								
		1 = Open/Close 2 = Bypass 3 = Restore 4 = Trouble	5 = Tamper 6 = Cancel 7 = Recent Closing 8 = Exit Error							
		Segment #4								
1 = Late to Close / Early to Open 2 = Auto Arm in Stay Mode 3 = Reserved 4 = Disables door delay in Night Mode	5 = Reserved 6 = Reserved 7 = Reserved 8 = Reserved									
Segment #5 RESERVED										
☞ 24	19	ENTRY/EXIT TIMERS								
		Segment #1 (Entry Time #1)	30							
		Segment #2 (Exit Time #1)	60							
		Segment #3 (Entry Time #2)	30							
		Segment #4 (Exit Time #2)	60							
Segments #5 & #6		Reserved								
☞ 25	20	ZONES 1-8, ZONE TYPES	3-5-6-6-6-6-6-6	-----						
26	20	ZONES 1-8, PARTITION SELECTION (Segment 1=Zone 1 thru Segment 8=Zone 8)								
		Segments	1	2	3	4	5	6	7	8
		Partition #1	1	1	1	1	1	1	1	1
		Partition #2	2	2	2	2	2	2	2	2
		Partition #3	3	3	3	3	3	3	3	3
		Partition #4	4	4	4	4	4	4	4	4
		Partition #5	5	5	5	5	5	5	5	5
		Partition #6	6	6	6	6	6	6	6	6
		Partition #7	7	7	7	7	7	7	7	7
Partition #8	8	8	8	8	8	8	8	8		

☞ 27	21	ZONES 9-16, ZONE TYPES	6-6-6-6-6-6-6-6				-----			
28	21	ZONES 9-16, PARTITION SELECTION (Segment 1=Zone 9 thru Segment 8=Zone 16)								
		Segments	1	2	3	4	5	6	7	8
		Partition #1	1	1	1	1	1	1	1	1
		Partition #2	2	2	2	2	2	2	2	2
		Partition #3	3	3	3	3	3	3	3	3
		Partition #4	4	4	4	4	4	4	4	4
		Partition #5	5	5	5	5	5	5	5	5
		Partition #6	6	6	6	6	6	6	6	6
		Partition #7	7	7	7	7	7	7	7	7
Partition #8	8	8	8	8	8	8	8	8		

LOC	PG	DESCRIPTION	DEFAULT					PROGRAMMING DATA		
29	21	ZONES 17-24, ZONE TYPES	6-6-6-6-6-6-6-6					-----		
30	21	ZONES 17-24, PARTITION SELECTION (Segment 1=Zone 17 thru Segment 8=Zone 24)								
		Segments	1	2	3	4	5	6	7	8
		Partition #1	1	1	1	1	1	1	1	1
		Partition #2	2	2	2	2	2	2	2	2
		Partition #3	3	3	3	3	3	3	3	3
		Partition #4	4	4	4	4	4	4	4	4
		Partition #5	5	5	5	5	5	5	5	5
		Partition #6	6	6	6	6	6	6	6	6
		Partition #7	7	7	7	7	7	7	7	7
Partition #8	8	8	8	8	8	8	8	8		
31	21	ZONES 25-32, ZONE TYPES	6-6-6-6-6-6-6-6					-----		
32	21	ZONES 25-32, PARTITION SELECTION (Segment 1=Zone 25 thru Segment 8=Zone 32)								
		Segments	1	2	3	4	5	6	7	8
		Partition #1	1	1	1	1	1	1	1	1
		Partition #2	2	2	2	2	2	2	2	2
		Partition #3	3	3	3	3	3	3	3	3
		Partition #4	4	4	4	4	4	4	4	4
		Partition #5	5	5	5	5	5	5	5	5
		Partition #6	6	6	6	6	6	6	6	6
		Partition #7	7	7	7	7	7	7	7	7
Partition #8	8	8	8	8	8	8	8	8		
33	21	ZONES 33-40, ZONE TYPES	6-6-6-6-6-6-6-6					-----		
34	21	ZONES 33-40, PARTITION SELECTION (Segment 1=Zone 33 thru Segment 8=Zone 40)								
		Segments	1	2	3	4	5	6	7	8
		Partition #1	1	1	1	1	1	1	1	1
		Partition #2	2	2	2	2	2	2	2	2
		Partition #3	3	3	3	3	3	3	3	3
		Partition #4	4	4	4	4	4	4	4	4
		Partition #5	5	5	5	5	5	5	5	5
		Partition #6	6	6	6	6	6	6	6	6
		Partition #7	7	7	7	7	7	7	7	7
Partition #8	8	8	8	8	8	8	8	8		
35	22	ZONES 41-48, ZONE TYPES	6-6-6-6-6-6-6-6					-----		
36	22	ZONES 41-48, PARTITION SELECTION (Segment 1=Zone 41 thru Segment 8=Zone 48)								
		Segments	1	2	3	4	5	6	7	8
		Partition #1	1	1	1	1	1	1	1	1
		Partition #2	2	2	2	2	2	2	2	2
		Partition #3	3	3	3	3	3	3	3	3
		Partition #4	4	4	4	4	4	4	4	4
		Partition #5	5	5	5	5	5	5	5	5
		Partition #6	6	6	6	6	6	6	6	6
		Partition #7	7	7	7	7	7	7	7	7
Partition #8	8	8	8	8	8	8	8	8		

LOC	PG	DESCRIPTION	DEFAULT	PROGRAMMING DATA
37	22	SIREN AND SYSTEM SUPERVISION		
Segment #1 (Circle numbers to program)				
	1	Siren sounds for telephone line cut while armed.		
	2	Siren sounds for telephone line cut while disarmed.		
	3	Siren blast at arming.		
	4	Siren blast at exit delay expiration.		
	5	Siren blast at closing kissoff.		
	6	Siren sounds during a cross-zone verification time.		
	7	Siren sounds for a tamper.		
	8	Siren blast one time for keyswitch arming, two times for disarming (Must be disabled for SIA CP-01 systems).		
Segment #2 (Circle numbers to program)				
	1	Convert siren driver to voltage out.		
	2	Siren sounds for expander trouble (required for U.L.).		
	3	Immediate Restore by zone.		
	4	Dynamic battery test performed upon arming.		
	5	Battery missing test performed every 12 seconds.		
	6	Manual bell test performed during [*]-[4]-[4] test function.		
	7	Manual communicator test performed during [*]-[4]-[4] test function.		
	8	Box tamper enabled.		
Segment #3 (Circle numbers to program)				
	1	Box Tamper report enabled.		
	2	AC Fail report enabled.		
	3	Low Battery report enabled.		
	4	Auxiliary power over current report enabled.		
	5	Siren supervision report enabled.		
	6	Telephone Line Cut report enabled.		
	7	Ground Fault Detection report enabled.		
	8	Expander trouble report enabled.		
Segment #4 (Circle numbers to program)				
	1	Failure To Communicate report enabled.		
	2	Log Full report enabled.		
	3	Autotest report enabled.		
	4	Start and End Programming report enabled.		
	5	End Download report enabled.		
	6	Sensor Low Battery report enabled.		
	7	Sensor Missing report enabled.		
	8	First to Open / Last to Close enabled.		
Segment #5 (Circle numbers to program)				
	1	Lost Clock service LED enable.		
	2	Zone Doubling enable.		
	3	Disable on-board eight zones.		
	4	Enables two trips on the same cross-zone to activate the alarm.		
	5	Disables bypass reports for force armed zones		
	6	Reserved.		
	7	Clock uses internal crystal.		
	8	Disable Temporal Siren on Fire (Do not disable on UL listed systems)		
Segment #6				
	1	Enable 2-wire Smoke Detector.		
	2	Reserved.		
	3	Enable Zone Activity in Hours (not Days)		
	4	Enable Daylight Savings Time (DST)		
	5	Reserved		
	6	Disable Clean Me report.		
	7-8	Reserved.		
Segment #7 - RESERVED				

LOC	PG	DESCRIPTION	DEFAULT	DATA	
38	23	SWINGER SHUTDOWN COUNT	1	-	
39	23	KEYPAD SOUNDER CONTROL			
		Segment #1 (Circle numbers to program)			
		1	Keypad sounds for Telephone Line Cut when in the Armed state.		
		2	Keypad sounds for Telephone Line Cut when in the Disarmed state.		
		3	Keypad sounds upon AC Power Failure.		
		4	Keypad sounds upon Low Battery Detection.		
		5	Keypad sounds during Cross Zone Trip Time.		
		6	Keypad sounds for Tamper Alarm.		
		7	Reserved.		
8	Keypad sounds for expander trouble (required for UL).				
40	23	SYSTEM TIMERS			
		Segment #1 Dynamic Battery Test duration (0-255 minutes)	0	-	
		Segment #2 AC Failure report delay (0-255 minutes)	5	-	
		Segment #3 Power Up Delay (0-60 seconds)	60	-	
		Segment #4 Siren Time (1-254 minutes)	8	-	
		Segment #5 Telephone Line Cut delay (0-255 seconds)	0	-	
		Segment #6 Cross Zone Time (0-255 minutes)	5	-	
		Segment #7 Chime Time in 50 mS increments (0-255)	3	-	
		Segment #8 Dialer delay (15-255 seconds)	30	-	
		Segment #9 Fire Alarm Verification Time (120-255 sec.)	0	-	
		Segment #10 Listen-In Time (0-255 seconds)	0	-	
		Segment #11 Zone Monitor Timer (0-255 Days)	0	-	
		Segment #12 - 14	Reserved		
41	23	SPECIAL FEATURES			
		Segment #1 (Circle numbers to program)			
		1	Enables 6-digit code option. All arm/disarm/Go To Program codes require six digits		
		2	Requires valid user code entry for [*]-[9]-[8] and [*]-[9]-[9] functions to work.		
		3	Enable Auto Cancel / Abort.		
		4	Enable Walk-Test Mode.		
		5	Enables Auto Force-arming with keyfob or keyswitch.		
		6	Reserved.		
		7	Reserved.		
8	Reserved.				
42	24	GO TO PROGRAM CODE	9-7-1-3-0-0	-----	
43	24	GO TO PROGRAM CODE PARTITION AND AUTHORIZATION			
		Segment #1 (Circle numbers to program)			
		1	Reserved.		
		2	Enables "Go To Program Code" as an arm only code.		
		3	Enables "Go To Program Code" as an arm only after closing.		
		4	Enables "Go To Program Code" as a master arm/disarm code (can change user codes)		
		5	Enables "Go To Program Code" as an arm/disarm code.		
		6	Enables "Go To Program Code" to bypass zones.		
		7	Enables "Go To Program Code" opening and closing reports.		
8	Reserved.				

LOC	PG	DESCRIPTION	DEFAULT	DATA		
43	24	Segment #2 (Circle numbers to program)				
		1 Enables "Go To Program Code" for partition #1.				
		2 Enables "Go To Program Code" for partition #2.				
		3 Enables "Go To Program Code" for partition #3.				
		4 Enables "Go To Program Code" for partition #4.				
		5 Enables "Go To Program Code" for partition #5.				
		6 Enables "Go To Program Code" for partition #6.				
		7 Enables "Go To Program Code" for partition #7.				
		8 Enables "Go To Program Code" for partition #8.				
 44	24	DURESS CODE	15-15-15-15-15	-----		
45	24	AUXILIARY OUTPUTS 1-4 PARTITION SELECTION				
		Segments	1	2	3	4
		Partition #1	1	1	1	1
		Partition #2	2	2	2	2
		Partition #3	3	3	3	3
		Partition #4	4	4	4	4
		Partition #5	5	5	5	5
		Partition #6	6	6	6	6
		Partition #7	7	7	7	7
		Partition #8	8	8	8	8
46	24	AUXILIARY OUTPUTS 1-4 SPECIAL TIMING				
		Segments	1	2	3	4
		Auxiliary output timed in minutes.	1	1	1	1
		Auxiliary output to latch.	2	2	2	2
		Auxiliary output to stop timing upon user code entry.	3	3	3	3
		Auxiliary output to activate only between closing and opening time.	4	4	4	4
		Auxiliary output to activate only between opening and closing time.	5	5	5	5
		Invert auxiliary output (0 volts going to 12 volts when activated).	6	6	6	6
		Reserved	7	7	7	7
		Reserved	8	8	8	8
47	25	AUXILIARY OUTPUT #1, EVENT & TIME				
		Segment #1: Program the event number for output #1 here.	0=Burglary alarm			
		Segment #2: Program the timing for output #1 here.	10 seconds			
48	25	AUXILIARY OUTPUT #2, EVENT & TIME				
		Segment #1: Program the event number for output #2 here.	1=Fire alarm			
		Segment #2: Program the timing for output #2 here.	10 seconds			
49	25	AUXILIARY OUTPUT #3, EVENT & TIME				
		Segment #1: Program the event number for output #3 here.	2= 24 Hour Alarm			
		Segment #2: Program the timing for output #3 here.	10 seconds			
50	25	AUXILIARY OUTPUT #4, EVENT & TIME				
		Segment #1: Program the event number for output #4 here.	21-Armed State			
		Segment #2: Program the timing for output #4 here.	0=Follow condition			
 51	26	AUTOTEST CONTROL				
		Segment #1: Program a "1" if the interval is hours, a "0" if in days. Add a "2" to suppress the daily test or a "3" to suppress the hourly test.	1			
		Segment #2: Program the autotest interval from 1-255 days or hours.	24			
		Segment #3: Program the autotest report in 24-hour time format.	2			
		Segment #4: Program the autotest report time, minutes after the hour.	0			

LOC	PG	DESCRIPTION	DEFAULT	DATA
52	26	OPENING TIME		
		Segment #1: Program the hour of the opening time.	8	
		Segment #2: Program the minutes after the hour of the opening time.	0	
53	26	CLOSING TIME / AUTO ARMING TIME		
		Segment #1: Program the hour of the closing time / auto arming time.	20	
		Segment #2: Program the minutes after hour of closing / auto arming time.	0	

54	26	DAYS OF THE WEEK EACH PARTITION IS OPEN								
		Segments	1	2	3	4	5	6	7	8
		Sunday	1	1	1	1	1	1	1	1
		Monday	2	2	2	2	2	2	2	2
		Tuesday	3	3	3	3	3	3	3	3
		Wednesday	4	4	4	4	4	4	4	4
		Thursday	5	5	5	5	5	5	5	5
		Friday	6	6	6	6	6	6	6	6
		Saturday	7	7	7	7	7	7	7	7
		Reserved	8	8	8	8	8	8	8	8

55	26	DAYS OF THE WEEK "AUTO ARMING" WILL OCCUR IN PARTITIONS 1-8								
		Segments	1	2	3	4	5	6	7	8
		Sunday	1	1	1	1	1	1	1	1
		Monday	2	2	2	2	2	2	2	2
		Tuesday	3	3	3	3	3	3	3	3
		Wednesday	4	4	4	4	4	4	4	4
		Thursday	5	5	5	5	5	5	5	5
		Friday	6	6	6	6	6	6	6	6
		Saturday	7	7	7	7	7	7	7	7
		Disable Retry	8	8	8	8	8	8	8	8

COMMUNICATOR CODES FOR SLOW SPEED FORMATS ONLY

The digit programmed in each of the following locations will be sent as the upper HEX digit in place of the alarm event code. The zone ID or user ID will always be reported as the lower HEX digit (1-F). For example, if the zone ID or user ID is 15, the 4+2 lower digit will be "F" and if the zone ID or user ID is 16, the 4+2 lower digit will be "1".
NOTE: If Segments 2-8 are left as "0" (unprogrammed), they will follow the Segment 1 selection. If Segment 1 is left as "0" and the feature is enabled, the NX-8E will report "'A".

LOC	PG	DESCRIPTION	DEFAULT	DATA
56	27	RESTORE COMMUNICATOR CODE, SLOW SPEED FORMATS ONLY		
		Segment #1: Partition #1 Restore code	0	--
		Segment #2: Partition #2 Restore code	0	--
		Segment #3: Partition #3 Restore code	0	--
		Segment #4: Partition #4 Restore code	0	--
		Segment #5: Partition #5 Restore code	0	--
		Segment #6: Partition #6 Restore code	0	--
		Segment #7: Partition #7 Restore code	0	--
		Segment #8: Partition #8 Restore code	0	--

LOC	PG	DESCRIPTION	DEFAULT	DATA
57	27	BYPASS COMMUNICATOR CODE, SLOW SPEED FORMATS ONLY		
		Segment #1: Partition #1 Bypass code	0	--
		Segment #2: Partition #2 Bypass code	0	--
		Segment #3: Partition #3 Bypass code	0	--
		Segment #4: Partition #4 Bypass code	0	--
		Segment #5: Partition #5 Bypass code	0	--
		Segment #6: Partition #6 Bypass code	0	--
		Segment #7: Partition #7 Bypass code	0	--
		Segment #8: Partition #8 Bypass code	0	--
58	27	TAMPER COMMUNICATOR CODE, SLOW SPEED FORMATS ONLY		
		Segment #1: Partition #1 Tamper Code	0	--
		Segment #2: Partition #2 Tamper Code	0	--
		Segment #3: Partition #3 Tamper Code	0	--
		Segment #4: Partition #4 Tamper Code	0	--
		Segment #5: Partition #5 Tamper Code	0	--
		Segment #6: Partition #6 Tamper Code	0	--
		Segment #7: Partition #7 Tamper Code	0	--
		Segment #8: Partition #8 Tamper Code	0	--
59	27	TROUBLE COMMUNICATOR CODE, SLOW SPEED FORMATS ONLY		
		Segment #1: Partition #1 Trouble Code	0	--
		Segment #2: Partition #2 Trouble Code	0	--
		Segment #3: Partition #3 Trouble Code	0	--
		Segment #4: Partition #4 Trouble Code	0	--
		Segment #5: Partition #5 Trouble Code	0	--
		Segment #6: Partition #6 Trouble Code	0	--
		Segment #7: Partition #7 Trouble Code	0	--
		Segment #8: Partition #8 Trouble Code	0	--
60	27	SENSOR LOW BATTERY COMMUNICATOR CODE, SLOW SPEED FORMATS ONLY		
		Segment #1: Partition #1 Sensor Low Battery Code	0	--
		Segment #2: Partition #2 Sensor Low Battery Code	0	--
		Segment #3: Partition #3 Sensor Low Battery Code	0	--
		Segment #4: Partition #4 Sensor Low Battery Code	0	--
		Segment #5: Partition #5 Sensor Low Battery Code	0	--
		Segment #6: Partition #6 Sensor Low Battery Code	0	--
		Segment #7: Partition #7 Sensor Low Battery Code	0	--
		Segment #8: Partition #8 Sensor Low Battery Code	0	--
61	27	SENSOR MISSING COMMUNICATOR CODE, SLOW SPEED FORMATS ONLY		
		Segment #1: Partition #1 Sensor Missing Code	0	--
		Segment #2: Partition #2 Sensor Missing Code	0	--
		Segment #3: Partition #3 Sensor Missing Code	0	--
		Segment #4: Partition #4 Sensor Missing Code	0	--
		Segment #5: Partition #5 Sensor Missing Code	0	--
		Segment #6: Partition #6 Sensor Missing Code	0	--
		Segment #7: Partition #7 Sensor Missing Code	0	--
		Segment #8: Partition #8 Sensor Missing Code	0	--

LOC	PG	DESCRIPTION	DEFAULT	DATA
62	27	DURESS	0-0	--
63	27	AUXILIARY 1	0-0	--
64	28	AUXILIARY 2	0-0	--
65	28	KEYPAD PANIC	0-0	--
66	28	KEYPAD MULTIPLE CODE ENTRY TAMPER	0-0	--
67	28	BOX TAMPER / BOX TAMPER RESTORE	0-0-0-0	----
68	28	AC FAIL / AC RESTORE	0-0-0-0	----

LOC	PG	DESCRIPTION	DEFAULT	DATA
69	28	LOW BATTERY / LOW BATTERY RESTORE	0-0-0-0	----
70	28	POWER SHORT / POWER SHORT RESTORE	0-0-0-0	----
71	28	BELL TAMPER / BELL TAMPER RESTORE	0-0-0-0	----
72	28	TELEPHONE LINE CUT / LINE CUT RESTORE	0-0-0-0	----
73	28	GROUND FAULT / GROUND FAULT RESTORE	0-0-0-0	----
74	29	EXPANDER TROUBLE / EXP TROUBLE RESTORE	0-0-0-0	----
75	29	FAILURE TO COMMUNICATE	0-0	--
76	29	LOG FULL COMMUNICATOR CODE	0-0	--
77	29	OPENING CODE COMMUNICATOR CODE		
		Segment #1: Opening Code for Partition #1	0	--
		Segment #2: Opening Code for Partition #2	0	--
		Segment #3: Opening Code for Partition #3	0	--
		Segment #4: Opening Code for Partition #4	0	--
		Segment #5: Opening Code for Partition #5	0	--
		Segment #6: Opening Code for Partition #6	0	--
		Segment #7: Opening Code for Partition #7	0	--
		Segment #8: Opening Code for Partition #8	0	--
78	29	CLOSING COMMUNICATOR CODE		
		Segment #1: Closing Code for Partition #1	0	--
		Segment #2: Closing Code for Partition #2	0	--
		Segment #3: Closing Code for Partition #3	0	--
		Segment #4: Closing Code for Partition #4	0	--
		Segment #5: Closing Code for Partition #5	0	--
		Segment #6: Closing Code for Partition #6	0	--
		Segment #7: Closing Code for Partition #7	0	--
		Segment #8: Closing Code for Partition #8	0	--
79	29	AUTOTEST COMMUNICATOR CODE	0-0	--
80	29	RECENT CLOSING AND EXIT ERROR	0-0	--
81	29	START PROGRAMMING / END PROGRAMMING	0-0-0-0	----
82	29	END DOWNLOAD	0-0-0-0	XX--
83	29	CANCEL COMMUNICATOR CODE	0	--
84-87	29	RESERVED	0-0-0-0	Reserved
88	30	PARTITION 1, ACCOUNT CODE	10-10-10-10-10-10	-----
89	30	PARTITION 2, ACCOUNT CODE	10-10-10-10-10-10	-----
90	30	PARTITION 2, FEATURE AND REPORTING SELECTION		
		Segment #1		
		1 Quick Arm	5 Audible Panic	
		2 Re-Exit	6 Auxiliary 1	
		3 Auto Bypass	7 Auxiliary 2	
		4 Silent Panic	8 Multi Keypress Tamper	
		Segment #2		
		1 LED extinguish enable	5 Enables bypass toggle	
		2 Require user code for bypassing zones	6 Enables silent auto arm	
		3 Bypass sounder alert	7 Enables automatic instant	
		4 AC power/low battery sounder alert	8 Reserved	
		Segment #3		
		1 Open/Close	5 Tamper	
		2 Bypass	6 Cancel	
		3 Restore	7 Recent Closing	
		4 Trouble	8 Exit Error	
		Segment #4		
		1 Late to Close / Early to Open		
		2-8 Reserved		
		Segment #5 RESERVED		

LOC	PG	DESCRIPTION	DEFAULT	DATA	
91	30	PARTITION 2 ENTRY/EXIT TIMERS			
		Segment #1 (Entry Time #1)		0	--
		Segment #2 (Exit Time #1)		0	--
		Segment #3 (Entry Time #2)		0	--
		Segment #4 (Exit Time #2)		0	--
		Segment #5 & #6 RESERVED			
92	30	PARTITION 3, ACCOUNT CODE	10-10-10-10-10-10	-----	
93	30	PARTITION 3, FEATURE AND REPORTING SELECTION			
		Segment #1			
		1	Quick Arm	5	Audible Panic
		2	Re-Exit	6	Auxiliary 1
		3	Auto Bypass	7	Auxiliary 2
		4	Silent Panic	8	Multi Keypress Tamper
		Segment #2			
		1	LED extinguish enable	5	Enables bypass toggle
		2	Require user code for bypassing zones	6	Enables silent auto arm
		3	Bypass sounder alert	7	Enables automatic instant
		4	AC power/low battery sounder alert	8	Reserved
		Segment #3			
		1	Open/Close	5	Tamper
		2	Bypass	6	Cancel
		3	Restore	7	Recent Closing
4	Trouble	8	Exit Error		
Segment #4					
1	Late to Close / Early to Open				
2-8	Reserved				
Segment #5 RESERVED					
94	30	PARTITION 3 ENTRY/EXIT TIMERS			
		Segment #1 (Entry Time #1)		0	--
		Segment #2 (Exit Time #1)		0	--
		Segment #3 (Entry Time #2)		0	--
		Segment #4 (Exit Time #2)		0	--
		Segment #5 & #6 RESERVED			
95	31	PARTITION 4, ACCOUNT CODE	10-10-10-10-10-10	-----	
96	31	PARTITION 4, FEATURE AND REPORTING SELECTION			
		Segment #1			
		1	Quick Arm	5	Audible Panic
		2	Re-Exit	6	Auxiliary 1
		3	Auto Bypass	7	Auxiliary 2
		4	Silent Panic	8	Multi Keypress Tamper
		Segment #2			
		1	LED extinguish enable	5	Enables bypass toggle
		2	Require user code for bypassing zones	6	Enables silent auto arm
		3	Bypass sounder alert	7	Enables automatic instant
		4	AC power/low battery sounder alert	8	Reserved
		Segment #3			
		1	Open/Close	5	Tamper
		2	Bypass	6	Cancel
		3	Restore	7	Recent Closing
4	Trouble	8	Exit Error		
Segment #4					
1	Late to Close / Early to Open				
2-8	Reserved				
Segment #5 RESERVED					

LOC	PG	DESCRIPTION	DEFAULT	DATA
97	31	PARTITION 4, ENTRY/EXIT TIMERS		
		Segment #1 (Entry Time #1)	0	--
		Segment #2 (Exit Time #1)	0	--
		Segment #3 (Entry Time #2)	0	--
		Segment #4 (Exit Time #2)	0	--
		Segment #5 & #6 RESERVED		
98	31	PARTITION 5, ACCOUNT CODE	10-10-10-10-10-10	-----
99	31	PARTITION 5, FEATURE AND REPORTING SELECTION		
		Segment #1		
		1 Quick Arm	5 Audible Panic	
		2 Re-Exit	6 Auxiliary 1	
		3 Auto Bypass	7 Auxiliary 2	
		4 Silent Panic	8 Multi Keypress Tamper	
		Segment #2		
		1 LED extinguish enable	5 Enables bypass toggle	
		2 Require user code for bypassing zones	6 Enables silent auto arm	
		3 Bypass sounder alert	7 Enables automatic instant	
		4 AC power/low battery sounder alert	8 Reserved	
		Segment #3		
		1 Open/Close	5 Tamper	
		2 Bypass	6 Cancel	
		3 Restore	7 Recent Closing	
4 Trouble	8 Exit Error			
Segment #4				
1 Late to Close / Early to Open				
2-8 Reserved				
Segment #5 RESERVED				
100	31	PARTITION 5, ENTRY/EXIT TIMERS		
		Segment #1 (Entry Time #1)	0	--
		Segment #2 (Exit Time #1)	0	--
		Segment #3 (Entry Time #2)	0	--
		Segment #4 (Exit Time #2)	0	--
		Segment #5 & #6 RESERVED		
101	31	PARTITION 6, ACCOUNT CODE	10-10-10-10-10-10	-----
102	31	PARTITION 6, FEATURE AND REPORTING SELECTION		
		Segment #1		
		1 Quick Arm	5 Audible Panic	
		2 Re-Exit	6 Auxiliary 1	
		3 Auto Bypass	7 Auxiliary 2	
		4 Silent Panic	8 Multi Keypress Tamper	
		Segment #2		
		1 LED extinguish enable	5 Enables bypass toggle	
		2 Require user code for bypassing zones	6 Enables silent auto arm	
		3 Bypass sounder alert	7 Enables automatic instant	
		4 AC power/low battery sounder alert	8 Reserved	
		Segment #3		
		1 Open/Close	5 Tamper	
		2 Bypass	6 Cancel	
		3 Restore	7 Recent Closing	
4 Trouble	8 Exit Error			
Segment #4				
1 Late to Close / Early to Open				
2-8 Reserved				
Segment #5 RESERVED				

LOC	PG	DESCRIPTION	DEFAULT	DATA	
103	32	PARTITION 6, ENTRY/EXIT TIMERS			
		Segment #1 (Entry Time #1)		0	--
		Segment #2 (Exit Time #1)		0	--
		Segment #3 (Entry Time #2)		0	--
		Segment #4 (Exit Time #2)		0	--
Segment #5 & #6 RESERVED					
104	32	PARTITION 7, ACCOUNT CODE	10-10-10-10-10	-----	
105	32	PARTITION 7, FEATURE AND REPORTING SELECTION			
		Segment #1			
		1	Quick Arm	5	Audible Panic
		2	Re-Exit	6	Auxiliary 1
		3	Auto Bypass	7	Auxiliary 2
		4	Silent Panic	8	Multi Keypress Tamper
		Segment #2			
		1	LED extinguish enable	5	Enables bypass toggle
		2	Require user code for bypassing zones	6	Enables silent auto arm
		3	Bypass sounder alert	7	Enables automatic instant
		4	AC power/low battery sounder alert	8	Reserved
		Segment #3			
		1	Open/Close	5	Tamper
		2	Bypass	6	Cancel
		3	Restore	7	Recent Closing
4	Trouble	8	Exit Error		
Segment #4					
1	Late to Close / Early to Open				
2-8	Reserved				
Segment #5 RESERVED					
106	32	PARTITION 7, ENTRY/EXIT TIMERS			
		Segment #1 (Entry Time #1)		0	--
		Segment #2 (Exit Time #1)		0	--
		Segment #3 (Entry Time #2)		0	--
		Segment #4 (Exit Time #2)		0	--
Segment #5 & #6 RESERVED					
107	32	PARTITION 8, ACCOUNT CODE	10-10-10-10-10	-----	
108	32	PARTITION 8, FEATURE AND REPORTING SELECTION			
		Segment #1			
		1	Quick Arm	5	Audible Panic
		2	Re-Exit	6	Auxiliary 1
		3	Auto Bypass	7	Auxiliary 2
		4	Silent Panic	8	Multi Keypress Tamper
		Segment #2			
		1	LED extinguish enable	5	Enables bypass toggle
		2	Require user code for bypassing zones	6	Enables silent auto arm
		3	Bypass sounder alert	7	Enables automatic instant
		4	AC power/low battery sounder alert	8	Reserved
		Segment #3			
		1	Open/Close	5	Tamper
		2	Bypass	6	Cancel
		3	Restore	7	Recent Closing
4	Trouble	8	Exit Error		
Segment #4					
1	Late to Close / Early to Open				
2-8	Reserved				
Segment #5 RESERVED					

LOC	PG	DESCRIPTION	DEFAULT	DATA	
109	32	PARTITION 8, ENTRY/EXIT TIMERS			
		Segment #1 (Entry Time #1)	0	--	
		Segment #2 (Exit Time #1)	0	--	
		Segment #3 (Entry Time #2)	0	--	
		Segment #4 (Exit Time #2)	0	--	
		Segment #5 & #6 RESERVED			
110	33	ZONE TYPE 1 ALARM EVENT CODE	8	--	
111	33	ZONE TYPE 1 CHARACTERISTIC SELECT			
		Segment #1 (Circle numbers to program)			
		1 Fire (enable for fire zone).	5 Delay 1 zone (enable to follow Timer 1 Entry/Exit times).		
		2 24 Hour (enable for non-fire 24 hour zone).	6 Delay 2 zone (enable to follow Timer 2 Entry / Exit times).		
		3 Keyswitch zone.	7 Interior (Enable for auto bypass or stay arming).		
		4 Follower (enable for burg zones that are instant during non-entry times).	8 Local Only (enable if zone is not to be reported).		
		Segment #2 (Circle numbers to program)			
		1 Keypad audible on alarm.	5 Bypassable.		
		2 Yelping siren on alarm.	6 Group Shunt.		
		3 Temporal siren on alarm.	7 Force armable.		
		4 Chime.	8 Entry Guard.		
		Segment #3 (Circle numbers to program)			
		1 Fast Loop Response.	5 Dialer Delay zone.		
		2 Double End of Line Tamper zone.	6 Swinger zone.		
		3 Trouble zone (Day zone).	7 Restore reporting.		
4 Cross Zone.	8 Listen-In.				
Segment #4 (Circle numbers to program)					
1 Zone Activity Monitor.	5 Reserved.				
2 End of Line Resistor Defeat.	6 Reserved.				
3 Zone acts as <i>request to exit</i> input.	7 Reserved.				
4 Zone acts as access control input.	8 Reserved.				
Segment #5 - Reserved					

THE DEFAULTS LISTED IN THE ODD NUMBERED LOCATIONS BELOW REPRESENT THE THREE SEGMENTS OF EACH OF THOSE LOCATIONS. USE THE THREE SEGMENT CHARTS FROM LOCATION 111 TO UNDERSTAND THESE DEFAULTS.

LOC	PG	DESCRIPTION	DEFAULT	DATA
112	33	ZONE TYPE 2 ALARM EVENT CODE	2	--
113	33	ZONE TYPE 2 CHARACTERISTIC SELECT	2-125-78-0-0	-----
114	33	ZONE TYPE 3 ALARM EVENT CODE	7	--
115	33	ZONE TYPE 3 CHARACTERISTIC SELECT	5-1245-5678-0-0	-----
116	34	ZONE TYPE 4 ALARM EVENT CODE	5	--
117	34	ZONE TYPE 4 CHARACTERISTIC SELECT	45-125-5678-0-0	-----
118	34	ZONE TYPE 5 ALARM EVENT CODE	5	--
119	34	ZONE TYPE 5 CHARACTERISTIC SELECT	457-125-5678-0-0	-----
120	34	ZONE TYPE 6 ALARM EVENT CODE	4	--
121	34	ZONE TYPE 6 CHARACTERISTIC SELECT	0-1245-5678-0-0	-----
122	34	ZONE TYPE 7 ALARM EVENT CODE	0	--
123	34	ZONE TYPE 7 CHARACTERISTIC SELECT	2-0-78-0-0	-----
124	34	ZONE TYPE 8 ALARM EVENT CODE	1	--
125	34	ZONE TYPE 8 CHARACTERISTIC SELECT	1-13-378-0-0	-----
126	34	ZONE TYPE 9 ALARM EVENT CODE	7	--
127	34	ZONE TYPE 9 CHARACTERISTIC SELECT	6-1245-5678-0-0	-----
128	34	ZONE TYPE 10 ALARM EVENT CODE	2	--
129	34	ZONE TYPE 10 CHARACTERISTIC SELECT	24-5-78-0-0	-----

LOC	PG	DESCRIPTION	DEFAULT	DATA
130	34	ZONE TYPE 11 ALARM EVENT CODE	3	___
131	34	ZONE TYPE 11 CHARACTERISTIC SELECT	3-0-0-0-0	_____
132	35	ZONE TYPE 12 ALARM EVENT CODE	5	___
133	35	ZONE TYPE 12 CHARACTERISTIC SELECT	457-125-45678-0-0	_____
134	35	ZONE TYPE 13 ALARM EVENT CODE	4	___
135	35	ZONE TYPE 13 CHARACTERISTIC SELECT	0-12458-5678-0-0	_____
136	35	ZONE TYPE 14 ALARM EVENT CODE	7	___
137	35	ZONE TYPE 14 CHARACTERISTIC SELECT	5-12456-5678-0-0	_____
138	35	ZONE TYPE 15 ALARM EVENT CODE	5	___
139	35	ZONE TYPE 15 CHARACTERISTIC SELECT	457-1256-5678-0-0	_____
140	35	ZONE TYPE 16 ALARM EVENT CODE	4	___
141	35	ZONE TYPE 16 CHARACTERISTIC SELECT	0-12456-5678-0-0	_____
142	35	ZONE TYPE 17 ALARM EVENT CODE	7	___
143	35	ZONE TYPE 17 CHARACTERISTIC SELECT	5-1245-25678-0-0	_____
144	35	ZONE TYPE 18 ALARM EVENT CODE	5	___
145	35	ZONE TYPE 18 CHARACTERISTIC SELECT	457-125-25678-0-0	_____
146	36	ZONE TYPE 19 ALARM EVENT CODE	4	___
147	36	ZONE TYPE 19 CHARACTERISTIC SELECT	0-1245-25678-0-0	_____
148	36	ZONE TYPE 20 ALARM EVENT CODE	7	___
149	36	ZONE TYPE 20 CHARACTERISTIC SELECT	6-1245-25678-0-0	_____
150	36	ZONE TYPE 21 ALARM EVENT CODE	15	___
151	36	ZONE TYPE 21 CHARACTERISTIC SELECT	24-15-78	_____
152	36	ZONE TYPE 22 ALARM EVENT CODE	20	___
153	36	ZONE TYPE 22 CHARACTERISTIC SELECT	24-15-78	_____
154	36	ZONE TYPE 23 ALARM EVENT CODE	21	___
155	36	ZONE TYPE 23 CHARACTERISTIC SELECT	24-15-78	_____
156	36	ZONE TYPE 24 ALARM EVENT CODE	22	___
157	36	ZONE TYPE 24 CHARACTERISTIC SELECT	1-13-378	_____
158	36	ZONE TYPE 25 ALARM EVENT CODE	14	___
159	36	ZONE TYPE 25 CHARACTERISTIC SELECT	248-45-0-0-0	_____
160	37	ZONE TYPE 26 ALARM EVENT CODE	5	___
161	37	ZONE TYPE 26 CHARACTERISTIC SELECT	467-125-5678-0-0	_____
162	37	ZONE TYPE 27 ALARM EVENT CODE	5	___
163	37	ZONE TYPE 27 CHARACTERISTIC SELECT	457-1257-5678-0-0	_____
164	37	ZONE TYPE 28 ALARM EVENT CODE	7	___
165	37	ZONE TYPE 28 CHARACTERISTIC SELECT	6-12457-5678-0-0	_____
166	37	ZONE TYPE 29 ALARM EVENT CODE	5	___
167	37	ZONE TYPE 29 CHARACTERISTIC SELECT	457-125-5678-1-0	_____
168	37	ZONE TYPE 30 ALARM EVENT CODE	7	___
169	37	ZONE TYPE 30 CHARACTERISTIC SELECT	5-1245-5678-1-0	_____

170	37	ZONES 49-56, ZONE TYPES	6-6-6-6-6-6-6-6	-----						
171	37	ZONES 49-56, PARTITION SELECTION (Segment 1=Zone 49 thru Segment 8=Zone 56)								
		Segments	1	2	3	4	5	6	7	8
		Partition #1	1	1	1	1	1	1	1	1
		Partition #2	2	2	2	2	2	2	2	2
		Partition #3	3	3	3	3	3	3	3	3
		Partition #4	4	4	4	4	4	4	4	4
		Partition #5	5	5	5	5	5	5	5	5
		Partition #6	6	6	6	6	6	6	6	6
		Partition #7	7	7	7	7	7	7	7	7
		Partition #8	8	8	8	8	8	8	8	8

LOC	PG	DESCRIPTION	DEFAULT	DATA						
172	37	ZONES 57-64, ZONE TYPES	6-6-6-6-6-6-6-6	-----						
173	38	ZONES 57-64, PARTITION SELECTION (Segment 1=Zone 57 thru Segment 8=Zone 64)								
		Segments	1	2	3	4	5	6	7	8
		Partition #1	1	1	1	1	1	1	1	1
		Partition #2	2	2	2	2	2	2	2	2
		Partition #3	3	3	3	3	3	3	3	3
		Partition #4	4	4	4	4	4	4	4	4
		Partition #5	5	5	5	5	5	5	5	5
		Partition #6	6	6	6	6	6	6	6	6
		Partition #7	7	7	7	7	7	7	7	7
Partition #8	8	8	8	8	8	8	8	8		
174	38	ZONES 65-72, ZONE TYPES	6-6-6-6-6-6-6-6	-----						
175	38	ZONES 65-72, PARTITION SELECTION (Segment 1=Zone 65 thru Segment 8=Zone 72)								
		Segments	1	2	3	4	5	6	7	8
		Partition #1	1	1	1	1	1	1	1	1
		Partition #2	2	2	2	2	2	2	2	2
		Partition #3	3	3	3	3	3	3	3	3
		Partition #4	4	4	4	4	4	4	4	4
		Partition #5	5	5	5	5	5	5	5	5
		Partition #6	6	6	6	6	6	6	6	6
		Partition #7	7	7	7	7	7	7	7	7
Partition #8	8	8	8	8	8	8	8	8		
176	38	ZONES 73-80, ZONE TYPES	6-6-6-6-6-6-6-6	-----						
177	38	ZONES 73-80, PARTITION SELECTION (Segment 1=Zone 73 thru Segment 8=Zone 80)								
		Segments	1	2	3	4	5	6	7	8
		Partition #1	1	1	1	1	1	1	1	1
		Partition #2	2	2	2	2	2	2	2	2
		Partition #3	3	3	3	3	3	3	3	3
		Partition #4	4	4	4	4	4	4	4	4
		Partition #5	5	5	5	5	5	5	5	5
		Partition #6	6	6	6	6	6	6	6	6
		Partition #7	7	7	7	7	7	7	7	7
Partition #8	8	8	8	8	8	8	8	8		
178	38	ZONES 81-88, ZONE TYPES	6-6-6-6-6-6-6-6	-----						
179	38	ZONES 81-88, PARTITION SELECTION (Segment 1=Zone 81 thru Segment 8=Zone 88)								
		Segments	1	2	3	4	5	6	7	8
		Partition #1	1	1	1	1	1	1	1	1
		Partition #2	2	2	2	2	2	2	2	2
		Partition #3	3	3	3	3	3	3	3	3
		Partition #4	4	4	4	4	4	4	4	4
		Partition #5	5	5	5	5	5	5	5	5
		Partition #6	6	6	6	6	6	6	6	6
		Partition #7	7	7	7	7	7	7	7	7
Partition #8	8	8	8	8	8	8	8	8		

LOC	PG	DESCRIPTION	DEFAULT	DATA						
180	38	ZONES 89-96, ZONE TYPES	6-6-6-6-6-6-6-6	-----						
181	39	ZONES 89-96, PARTITION SELECTION (Segment 1=Zone 89 thru Segment 8=Zone 96)								
		Segments	1	2	3	4	5	6	7	8
		Partition #1	1	1	1	1	1	1	1	1
		Partition #2	2	2	2	2	2	2	2	2
		Partition #3	3	3	3	3	3	3	3	3
		Partition #4	4	4	4	4	4	4	4	4
		Partition #5	5	5	5	5	5	5	5	5
		Partition #6	6	6	6	6	6	6	6	6
		Partition #7	7	7	7	7	7	7	7	7
Partition #8	8	8	8	8	8	8	8	8		
182	39	ZONES 97-104, ZONE TYPES	6-6-6-6-6-6-6-6	-----						
183	39	ZONES 97-104, PARTITION SELECTION (Segment 1=Zone 97 thru Segment 8=Zone 104)								
		Segments	1	2	3	4	5	6	7	8
		Partition #1	1	1	1	1	1	1	1	1
		Partition #2	2	2	2	2	2	2	2	2
		Partition #3	3	3	3	3	3	3	3	3
		Partition #4	4	4	4	4	4	4	4	4
		Partition #5	5	5	5	5	5	5	5	5
		Partition #6	6	6	6	6	6	6	6	6
		Partition #7	7	7	7	7	7	7	7	7
Partition #8	8	8	8	8	8	8	8	8		
184	39	ZONES 105-112, ZONE TYPES	6-6-6-6-6-6-6-6	-----						
185	39	ZONES 105-112, PARTITION SELECTION (Segment 1=Zone 105 thru Segment 8=Zone 112)								
		Segments	1	2	3	4	5	6	7	8
		Partition #1	1	1	1	1	1	1	1	1
		Partition #2	2	2	2	2	2	2	2	2
		Partition #3	3	3	3	3	3	3	3	3
		Partition #4	4	4	4	4	4	4	4	4
		Partition #5	5	5	5	5	5	5	5	5
		Partition #6	6	6	6	6	6	6	6	6
		Partition #7	7	7	7	7	7	7	7	7
Partition #8	8	8	8	8	8	8	8	8		
186	39	ZONES 113-120, ZONE TYPES	6-6-6-6-6-6-6-6	-----						
187	39	ZONES 113-120, PARTITION SELECTION (Segment 1=Zone 113 thru Segment 8=Zone 120)								
		Segments	1	2	3	4	5	6	7	8
		Partition #1	1	1	1	1	1	1	1	1
		Partition #2	2	2	2	2	2	2	2	2
		Partition #3	3	3	3	3	3	3	3	3
		Partition #4	4	4	4	4	4	4	4	4
		Partition #5	5	5	5	5	5	5	5	5
		Partition #6	6	6	6	6	6	6	6	6
		Partition #7	7	7	7	7	7	7	7	7
Partition #8	8	8	8	8	8	8	8	8		

LOC	PG	DESCRIPTION	DEFAULT	DATA						
188	39	ZONES 121-128, ZONE TYPES	6-6-6-6-6-6-6-6	-----						
189	39	ZONES 121-128, PARTITION SELECTION (Segment 1=Zone 121 thru Segment 8=Zone 128)								
		Segments	1	2	3	4	5	6	7	8
		Partition #1	1	1	1	1	1	1	1	1
		Partition #2	2	2	2	2	2	2	2	2
		Partition #3	3	3	3	3	3	3	3	3
		Partition #4	4	4	4	4	4	4	4	4
		Partition #5	5	5	5	5	5	5	5	5
		Partition #6	6	6	6	6	6	6	6	6
		Partition #7	7	7	7	7	7	7	7	7
		Partition #8	8	8	8	8	8	8	8	8
190	40	ZONES 129-136, ZONE TYPES	6-6-6-6-6-6-6-6	-----						
191	40	ZONES 129-136, PARTITION SELECTION (Segment 1=Zone 129 thru Segment 8=Zone 136)								
		Segments	1	2	3	4	5	6	7	8
		Partition #1	1	1	1	1	1	1	1	1
		Partition #2	2	2	2	2	2	2	2	2
		Partition #3	3	3	3	3	3	3	3	3
		Partition #4	4	4	4	4	4	4	4	4
		Partition #5	5	5	5	5	5	5	5	5
		Partition #6	6	6	6	6	6	6	6	6
		Partition #7	7	7	7	7	7	7	7	7
		Partition #8	8	8	8	8	8	8	8	8
192	40	ZONES 137-144, ZONE TYPES	6-6-6-6-6-6-6-6	-----						
193	40	ZONES 137-144, PARTITION SELECTION (Segment 1=Zone 137 thru Segment 8=Zone 144)								
		Segments	1	2	3	4	5	6	7	8
		Partition #1	1	1	1	1	1	1	1	1
		Partition #2	2	2	2	2	2	2	2	2
		Partition #3	3	3	3	3	3	3	3	3
		Partition #4	4	4	4	4	4	4	4	4
		Partition #5	5	5	5	5	5	5	5	5
		Partition #6	6	6	6	6	6	6	6	6
		Partition #7	7	7	7	7	7	7	7	7
		Partition #8	8	8	8	8	8	8	8	8
194	40	ZONES 145-152, ZONE TYPES	6-6-6-6-6-6-6-6	-----						
195	40	ZONES 145-152, PARTITION SELECTION (Segment 1=Zone 145 thru Segment 8=Zone 152)								
		Segments	1	2	3	4	5	6	7	8
		Partition #1	1	1	1	1	1	1	1	1
		Partition #2	2	2	2	2	2	2	2	2
		Partition #3	3	3	3	3	3	3	3	3
		Partition #4	4	4	4	4	4	4	4	4
		Partition #5	5	5	5	5	5	5	5	5
		Partition #6	6	6	6	6	6	6	6	6
		Partition #7	7	7	7	7	7	7	7	7
		Partition #8	8	8	8	8	8	8	8	8

LOC	PG	DESCRIPTION	DEFAULT	DATA						
196	40	ZONES 153-160, ZONE TYPES	6-6-6-6-6-6-6	-----						
197	40	ZONES 153-160, PARTITION SELECTION (Segment 1=Zone 153 thru Segment 8=Zone 160)								
		Segments	1	2	3	4	5	6	7	8
		Partition #1	1	1	1	1	1	1	1	1
		Partition #2	2	2	2	2	2	2	2	2
		Partition #3	3	3	3	3	3	3	3	3
		Partition #4	4	4	4	4	4	4	4	4
		Partition #5	5	5	5	5	5	5	5	5
		Partition #6	6	6	6	6	6	6	6	6
		Partition #7	7	7	7	7	7	7	7	7
		Partition #8	8	8	8	8	8	8	8	8
198	41	ZONES 161-168, ZONE TYPES	6-6-6-6-6-6-6	-----						
199	41	ZONES 161-168, PARTITION SELECTION (Segment 1=Zone 161 thru Segment 8=Zone 168)								
		Segments	1	2	3	4	5	6	7	8
		Partition #1	1	1	1	1	1	1	1	1
		Partition #2	2	2	2	2	2	2	2	2
		Partition #3	3	3	3	3	3	3	3	3
		Partition #4	4	4	4	4	4	4	4	4
		Partition #5	5	5	5	5	5	5	5	5
		Partition #6	6	6	6	6	6	6	6	6
		Partition #7	7	7	7	7	7	7	7	7
		Partition #8	8	8	8	8	8	8	8	8
200	41	ZONES 169-176, ZONE TYPES	6-6-6-6-6-6-6	-----						
201	41	ZONES 169-176, PARTITION SELECTION (Segment 1=Zone 169 thru Segment 8=Zone 176)								
		Segments	1	2	3	4	5	6	7	8
		Partition #1	1	1	1	1	1	1	1	1
		Partition #2	2	2	2	2	2	2	2	2
		Partition #3	3	3	3	3	3	3	3	3
		Partition #4	4	4	4	4	4	4	4	4
		Partition #5	5	5	5	5	5	5	5	5
		Partition #6	6	6	6	6	6	6	6	6
		Partition #7	7	7	7	7	7	7	7	7
		Partition #8	8	8	8	8	8	8	8	8
202	41	ZONES 177-184, ZONE TYPES	6-6-6-6-6-6-6	-----						
203	41	ZONES 177-184, PARTITION SELECTION (Segment 1=Zone 177 thru Segment 8=Zone 184)								
		Segments	1	2	3	4	5	6	7	8
		Partition #1	1	1	1	1	1	1	1	1
		Partition #2	2	2	2	2	2	2	2	2
		Partition #3	3	3	3	3	3	3	3	3
		Partition #4	4	4	4	4	4	4	4	4
		Partition #5	5	5	5	5	5	5	5	5
		Partition #6	6	6	6	6	6	6	6	6
		Partition #7	7	7	7	7	7	7	7	7
		Partition #8	8	8	8	8	8	8	8	8

LOC	PG	DESCRIPTION	DEFAULT	DATA						
204	41	ZONES 185-192, ZONE TYPES	6-6-6-6-6-6-6-6	-----						
205	41	ZONES 185-192, PARTITION SELECTION (Segment 1=Zone 185 thru Segment 8=Zone 192)								
		Segments	1	2	3	4	5	6	7	8
		Partition #1	1	1	1	1	1	1	1	1
		Partition #2	2	2	2	2	2	2	2	2
		Partition #3	3	3	3	3	3	3	3	3
		Partition #4	4	4	4	4	4	4	4	4
		Partition #5	5	5	5	5	5	5	5	5
		Partition #6	6	6	6	6	6	6	6	6
		Partition #7	7	7	7	7	7	7	7	7
Partition #8	8	8	8	8	8	8	8	8		
206	42	DAYS OF THE WEEK "AUTO DISARMING" WILL OCCUR IN PARTITIONS 1-8								
		Segments	1	2	3	4	5	6	7	8
		Sunday	1	1	1	1	1	1	1	1
		Monday	2	2	2	2	2	2	2	2
		Tuesday	3	3	3	3	3	3	3	3
		Wednesday	4	4	4	4	4	4	4	4
		Thursday	5	5	5	5	5	5	5	5
		Friday	6	6	6	6	6	6	6	6
		Saturday	7	7	7	7	7	7	7	7
Reserved	8	8	8	8	8	8	8	8		
207	42	SERIAL PORT ENABLE 0 = Disabled 1 = Home Automation Protocol Enabled 2 = Serial Printer Mode	0	-						
208	42	SERIAL PORT BAUD RATE 0 = 2400 (2.4K) 3 = 19200 (19.2K) 1 = 4800 (4.8K) 4 = 38400 (38.4K) 2 = 9600 (9.6K) 5-7 = Reserved	2							
209	42	HOME AUTOMATION PROTOCOL 1 = LED Off = Binary LED On = ASCII 2 = Enables serial port supervision 3-8 = Reserved	Off							
210	42	NX-8E TRANSITION-BASED BROADCASTS								
		Segment #1	Segment #2							
		1 = Reserved 2 = Interface Configuration 3-4 = Reserved 5 = Zone Status Message 6 = Zones Snapshot Message 7 = Partition Status Message 8 = Partitions Snapshot Message	1 = System Status Message 2 = X-10 Message Received 3 = Log Event Message 4 = Keypad Message Received 5 -8 = Reserved							

211	43	NX-584 COMMAND/REQUEST ENABLE																																																																																		
		Segment #1	Segment #2																																																																																	
		1 = Reserved 2 = Interface Configuration Request 3 = Reserved 4 = Zone Name Request 5 = Zone Status Request 6 = Zones Snapshot Request 7 = Partition Status Request 8 = Partitions Snapshot Request	1 = System Status Request 2 = Send X-10 Message 3 = Log Event Request 4 = Send Keypad Text Message 5 = Keypad Terminal Mode Request 6-8 = Reserved																																																																																	
		Segment #3	Segment #4																																																																																	
		1 = Program Data Request 2 = Program Data Command 3 = User Information Request with PIN 4 = User Information Request without PIN 5 = Set User Code Command with PIN 6 = Set User Code Command without PIN 7 = Set User Authorization Comm with PIN 8 = Set User Authorization Comm without PIN	1-2 = Reserved 3 = Store Communication Event Command 4 = Set Clock / Calendar Command 5 = Primary Keypad Function with PIN 6 = Primary Keypad Function without PIN 7 = Secondary Keypad Function 8 = Zone Bypass Toggle																																																																																	
212	44	LCD KEYPAD ADDRESS FOR NX-584 192																																																																																		
		<table border="1"> <thead> <tr> <th>KP</th> <th>PART 1</th> <th>PART 2</th> <th>PART 3</th> <th>PART 4</th> <th>PART 5</th> <th>PART 6</th> <th>PART 7</th> <th>PART 8</th> </tr> </thead> <tbody> <tr> <td>1</td> <td>192</td> <td>193</td> <td>194</td> <td>195</td> <td>196</td> <td>197</td> <td>198</td> <td>199</td> </tr> <tr> <td>2</td> <td>200</td> <td>201</td> <td>202</td> <td>203</td> <td>204</td> <td>205</td> <td>206</td> <td>207</td> </tr> <tr> <td>3</td> <td>208</td> <td>209</td> <td>210</td> <td>211</td> <td>212</td> <td>213</td> <td>214</td> <td>215</td> </tr> <tr> <td>4</td> <td>216</td> <td>217</td> <td>218</td> <td>219</td> <td>220</td> <td>221</td> <td>222</td> <td>223</td> </tr> <tr> <td>5</td> <td>224</td> <td>225</td> <td>226</td> <td>227</td> <td>228</td> <td>229</td> <td>230</td> <td>231</td> </tr> <tr> <td>6</td> <td>232</td> <td>233</td> <td>234</td> <td>235</td> <td>236</td> <td>237</td> <td>238</td> <td>239</td> </tr> <tr> <td>7</td> <td>240</td> <td>241</td> <td>242</td> <td>243</td> <td>244</td> <td>245</td> <td>246</td> <td>247</td> </tr> <tr> <td>8</td> <td>248</td> <td>249</td> <td>250</td> <td>251</td> <td>252</td> <td>253</td> <td>254</td> <td>255</td> </tr> </tbody> </table>		KP	PART 1	PART 2	PART 3	PART 4	PART 5	PART 6	PART 7	PART 8	1	192	193	194	195	196	197	198	199	2	200	201	202	203	204	205	206	207	3	208	209	210	211	212	213	214	215	4	216	217	218	219	220	221	222	223	5	224	225	226	227	228	229	230	231	6	232	233	234	235	236	237	238	239	7	240	241	242	243	244	245	246	247	8	248	249	250	251	252	253	254	255
KP	PART 1	PART 2	PART 3	PART 4	PART 5	PART 6	PART 7	PART 8																																																																												
1	192	193	194	195	196	197	198	199																																																																												
2	200	201	202	203	204	205	206	207																																																																												
3	208	209	210	211	212	213	214	215																																																																												
4	216	217	218	219	220	221	222	223																																																																												
5	224	225	226	227	228	229	230	231																																																																												
6	232	233	234	235	236	237	238	239																																																																												
7	240	241	242	243	244	245	246	247																																																																												
8	248	249	250	251	252	253	254	255																																																																												
213		RESERVED																																																																																		

XIII. NX-8E WIRING DIAGRAM

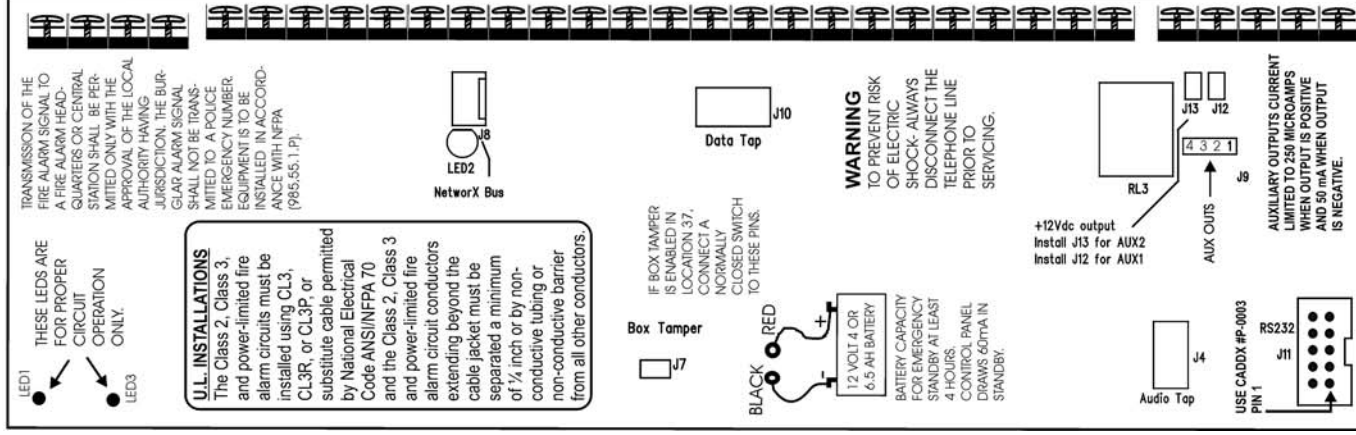
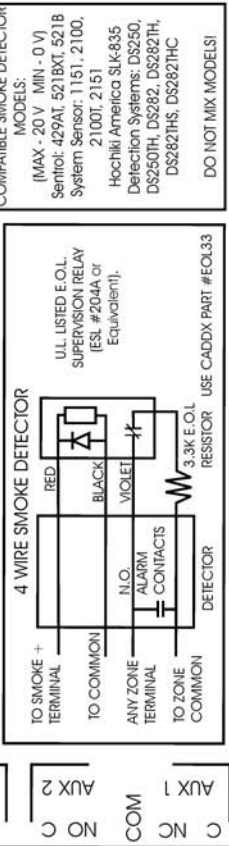
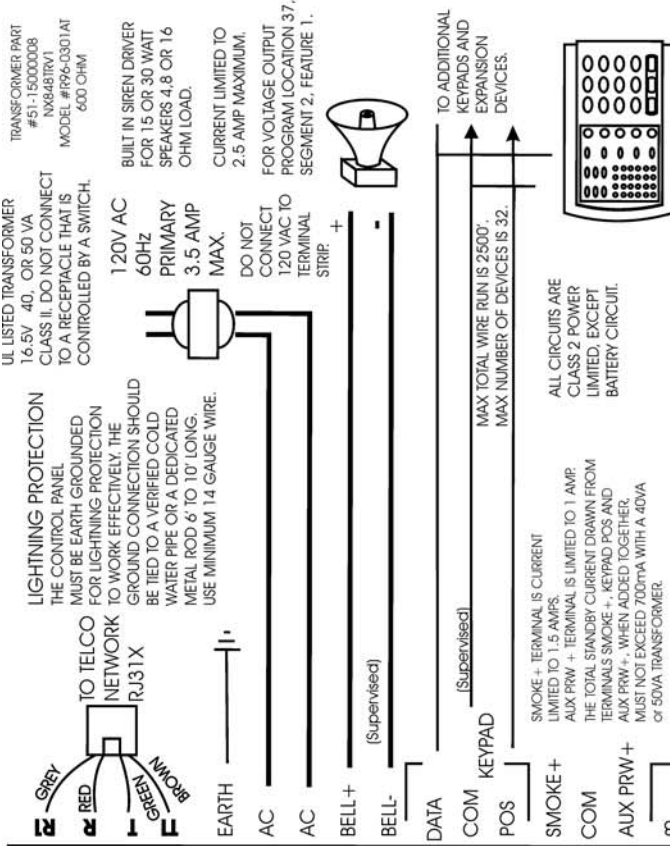
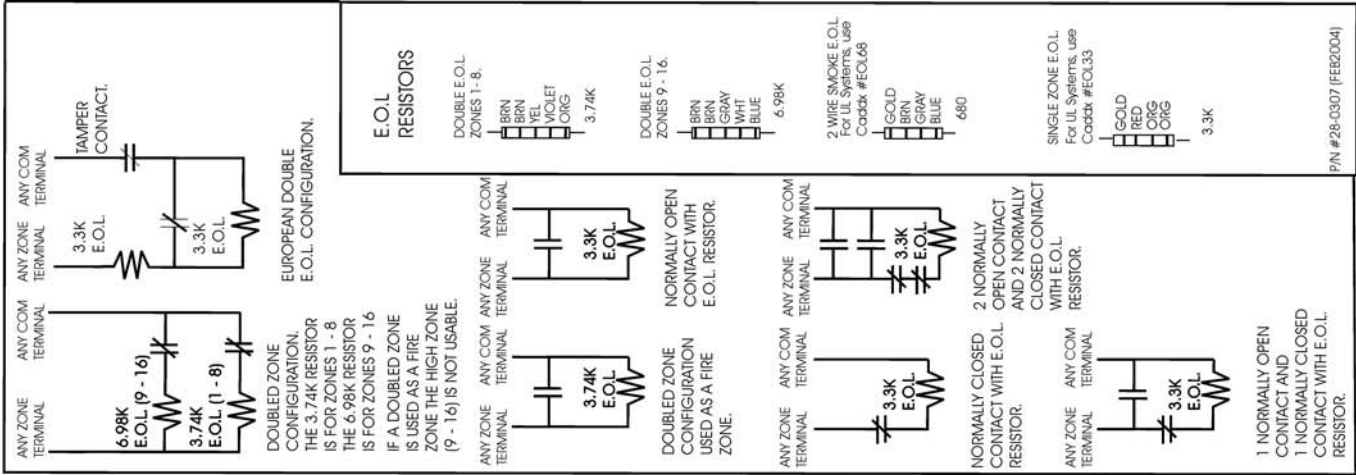

XIV. TERMINAL DESCRIPTIONS

TERMINAL	DESCRIPTION	
R1	House Telephone Ring (Grey).	
R	Telephone Ring (Red).	
T	Telephone Tip (Green).	
T1	House Telephone Tip (Brown).	
EARTH	Earth Ground. Connect to a cold water pipe or a 6 to 10 foot driven rod.	
AC	AC input. Connect to a 16.5V, 40VA or 50 VA Class II U.L. approved transformer.	
BELL + & BELL -	If used as a siren output (default), the speaker rating should be 15 watt at 8 or 16 ohm, or 30/40 watt at 4, 8, or 16 ohms. If voltage output is selected in location 37, this output becomes voltage output, 12VDC, 1 Amp maximum load. NOTE: A 3.3K Ω resistor may be required across the bell terminals when a 12 VDC siren is used. If no resistor is used, you may experience voltage leakage into the siren, which will cause these devices to output a small signal.	
KP DATA	Connect to the data terminal on the keypads and the expanders. Maximum number of devices (keypads + expanders) is 32. See "Maximum Wire Run" chart below.	
KP COM	Connect to the Common terminal on the keypads and the expanders.	
KP POS	Connect to the POS terminal on the keypads and the expanders. Individually, this terminal is limited to 1 Amp. Combined, this terminal and AUX PWR + are limited to 2 amps total current.	
SMOKE+	Smoke detector power 12VDC, 1.5 amps maximum (For those jurisdictions which allow the Priority zone to be used with smoke detectors.)	
COM	Connect negative wire of powered devices such as motion detectors and smoke detectors.	
AUX PWR+	Connect positive wire of all powered devices except smoke detectors and keypads. Individually, this terminal is limited to 1 Amp. Combined, this terminal and KP POS are limited to 2 amps total current.	
ZONE 8	Connect to one side of zone 8 loop. Connect the other side to com terminal. Open or short causes alarm. Zone 8 may be used for a two-wire smoke detector using a 680 Ω E.O.L. resistor. Connect one side to AUX PWR+ ONLY if using 2-wire smoke. Refer to wiring diagram. Program location 37, segment 6, option 1.	
COM	Common (-) terminal for zones 7 & 8. (See the wiring diagram for examples.)	
ZONE 7	Connect to one side of zone 7 loop. Connect the other side to COM terminal. Open or short causes alarm.	
ZONE 6 - ZONE 1	Connect as described for zones 7 & 8. Only zone 8 can be a two-wire zone. (See the wiring diagram for examples.)	
RELAY 2	C	Closed dry contact rated 1 Amp at 30 Volts.
	NO	Normally open dry contact rated 1 Amp at 30 Volts.
	COM	Common used to ground any devices connected to relays.
RELAY 1	NC	Normally closed dry contact rated 1 Amp at 30 Volts
	C	Closed dry contact rated 1 Amp at 30 Volts
(See terminal drawing)	AUX 1- AUX 4	Connect negative lead of low current device [relay, LED (install 1k Ω resistor in series with LED), etc.]. Connect positive lead of device to AUX PWR +. Current is limited to 50mA when output is negative, and 250 μ A when output is positive. Part number #8920 is 4-wire cable.

NOTE: These terminals can be set for 12VDC. Install J12 for AUX1 and J13 for AUX2 (See terminal drawing.)

KEYPAD MAXIMUM WIRE RUN

(Note: These numbers are for one keypad at the end of the wire. When connecting more than one keypad to the end of the wire, a higher gauge wire will be required.)

Length in feet	WHEN CONNECTED TO NX-8E	WHEN CONNECTED TO NX-320E
	Wire Gauge	Wire Gauge
250	24	22
500	20	18
1000	18	16
1500	16	14
2500	14	12

ZONE WORKSHEET

1		49		97		145	
2		50		98		146	
3		51		99		147	
4		52		100		148	
5		53		101		149	
6		54		102		150	
7		55		103		151	
8		56		104		152	
9		57		105		153	
10		58		106		154	
11		59		107		155	
12		60		108		156	
13		61		109		157	
14		62		110		158	
15		63		111		159	
16		64		112		160	
17		65		113		161	
18		66		114		162	
19		67		115		163	
20		68		116		164	
21		69		117		165	
22		70		118		166	
23		71		119		167	
24		72		120		168	
25		73		121		169	
26		74		122		170	
27		75		123		171	
28		76		124		172	
29		77		125		173	
30		78		126		174	
31		79		127		175	
32		80		128		176	
33		81		129		177	
34		82		130		178	
35		83		131		179	
36		84		132		180	
37		85		133		181	
38		86		134		182	
39		87		135		183	
40		88		136		184	
41		89		137		185	
42		90		138		186	
43		91		139		187	
44		92		140		188	
45		93		141		189	
46		94		142		190	
47		95		143		191	
48		96		144		192	

XV. APPENDIX 1

REPORTING FIXED CODES IN CONTACT ID AND SIA

The table lists the event codes sent for the following reports (if enabled) when using CONTACT ID or SIA formats.

<u>REPORT</u>	<u>CONTACT ID</u>	<u>SIA</u>
MANUAL TEST.....	601.....	RX
AUTOTEST.....	602.....	RP
OPEN (user number).....	401.....	OP
CLOSE (user number).....	401.....	CL
CANCEL (user number).....	406.....	OC
DOWNLOAD COMPLETE.....	412.....	RS
START PROGRAM.....	627.....	LB
END PROGRAM.....	628.....	LX
GROUND FAULT.....	310.....	GF
GROUND FAULT RESTORE.....	310.....	GK
RECENT CLOSE (user number).....	401.....	CR
EXIT ERROR (user number).....	457.....	EE
EVENT LOG FULL.....	605.....	JL
FAIL TO COMMUNICATE.....	354.....	RT
EXPANDER TROUBLE (device number).....	333.....	ET
EXPANDER RESTORE (device number).....	333.....	ER
TELEPHONE FAULT.....	351.....	LT
TELEPHONE RESTORE.....	351.....	LR
SIREN TAMPER (device number).....	321.....	YA
SIREN RESTORE (device number).....	321.....	YH
AUX POWER OVER CURRENT (device number).....	312.....	YP
AUX POWER RESTORE (device number).....	312.....	YQ
LOW BATTERY (device number).....	309.....	YT
LOW BATTERY RESTORE (device number).....	309.....	YR
AC FAIL (device number).....	301.....	AT
AC RESTORE (device number).....	301.....	AR
BOX TAMPER (device number).....	137.....	TA
BOX TAMPER RESTORE (device number).....	137.....	TR
KEYPAD TAMPER.....	137.....	TA
KEYPAD PANIC (audible).....	120.....	PA
KEYPAD PANIC (silent).....	121.....	HA
DURESS.....	121.....	HA
KEYPAD AUXILIARY 1.....	110.....	FA
KEYPAD AUXILIARY 2.....	100.....	MA
RF SENSOR LOST (zone number).....	381.....	*T
RF SENSOR RESTORE (zone number).....	381.....	*R
SENSOR LOW BATTERY (zone number).....	384.....	XT
SENSOR BATTERY RESTORE (zone number).....	384.....	XR
ZONE TROUBLE (zone number).....	380.....	*T
ZONE TROUBLE RESTORE (zone number).....	380.....	*R
ZONE TAMPER (zone number).....	137.....	TA
ZONE TAMPER RESTORE (zone number).....	137.....	TR
ZONE BYPASS (zone number).....	570.....	*B
BYPASS RESTORE (zone number).....	570.....	*U
EARLY OPEN/LATE CLOSE.....	451.....	OK
FAIL TO CLOSE.....	454.....	CI
ZONE ACTIVITY FAULT.....	391.....	NA
ZONE ACTIVITY RESTORE.....	391.....	NS
CLEAN ME ALARM.....	393.....	YX
CLEAN ME RESTORE.....	393.....	YZ
FORCED DOOR.....	423.....	DF
FORCED DOOR RESTORE.....	423.....	DR

THE NUMBER IN PARENTHESES FOLLOWING THE EVENT IS THE NUMBER THAT WILL BE REPORTED AS THE ZONE NUMBER. IF THERE ARE NO PARENTHESES, THE ZONE WILL BE "0". SEE PAGE 71 FOR THE DEVICE NUMBERS.

* The character transmitted in this slot will be the first character from the event code of the zone that is bypassed or in trouble. (See locations 110 - 141)

XVI. APPENDIX 2

REPORTING ZONE CODES IN SIA OR CONTACT ID

The NX-8E has the ability to report SIA level 1 transmissions to either or both phone numbers. Each report in SIA consists of an Event Code and a Zone or User ID. The Zone ID will be the zone number that is in alarm. The event code will come from the chart below and be programmed in the zone type event code.

<u>Programmed Event Code</u>	<u>SIA Code</u>	<u>Description</u>
0	HA	Holdup Alarm
1	FA	Fire Alarm
2	PA	Panic alarm
3	BA	Burglary Alarm
4	BA	Burglary Alarm
5	BA	Burglary Alarm
6	UA	Untyped Alarm
7	BA	Burglary Alarm
8	BA	Burglary Alarm
9	UA	Untyped Alarm
10	HA	Holdup Alarm
11	MA	Medical Alarm
12	PA	Panic alarm
13	TA	Tamper Alarm
14	RP	Periodic Test
15	GA	Gas Alarm
16	KA	Heat Alarm
17	WA	Water Alarm
18	QA	Emergency Alarm
19	SA	Sprinkler Alarm
20	ZA	Freeze Alarm
21	KH	High Temp Alarm
22	FA	Manual Fire Alarm

The NX-8E has the ability to report Ademco Contact ID transmissions. Each report in Contact ID consists of an Event Code and a Zone ID. The zone ID is the zone that created the alarm. The event code will come from the chart below and be programmed in the zone type event code.

<u>Programmed Event Code</u>	<u>Contact ID Code</u>	<u>Description</u>
0	122	Silent Panic
1	110	Fire Alarm
2	120	Panic alarm
3	130	Burglary Alarm
4	131	Perimeter Alarm
5	132	Interior Alarm
6	133	24 Hour Burglary
7	134	Entry Alarm
8	135	Day/Night Alarm
9	150	Non Burglary 24 Hour
10	121	Duress Alarm
11	100	Medical Alarm
12	123	Audible Panic Alarm
13	137	Tamper Alarm
14	602	Periodic Test
15	151	Gas Detected
16	158	High Temp
17	154	Water Leakage
18	140	General Alarm
19	140	General Alarm
20	159	Low Temp
21	158	High Temp Alarm
22	115	Manual Fire Alarm

XVII. APPENDIX 3

EXPANDER NUMBERS FOR REPORTING EXPANDER TROUBLE

The tables below list the device numbers that will be reported for trouble conditions.

Device	Device # reported
NX-8E Control Panel	0
NX-534E Two Way Listen-In	64
NX-540E "Operator"	40
NX-591E Cellemetry Interface	76
NX-870E Fire Supervision	9

See page 69 for possible report codes.

KEYPADS

KEYPAD	PART 1	PART 2	PART 3	PART 4	PART 5	PART 6	PART 7	PART 8
1	192	193	194	195	196	197	198	199
2	200	201	202	203	204	205	206	207
3	208	209	210	211	212	213	214	215
4	216	217	218	219	220	221	222	223
5	224	225	226	227	228	229	230	231
6	232	233	234	235	236	237	238	239
7	240	241	242	243	244	245	246	247
8	248	249	250	251	252	253	254	255

HARDWIRE EXPANDER (NX-216E)

Starting zone number	Expander # reported	Starting zone number	Expander # reported
Zone 09 (All switches off)	22	Zone 97 (Switches 3 & 4 on)	100
Zone 09 (Switch 1 on)	23	Zone 105 (Switches 1, 3 & 4 on)	101
Zone 17 (Switch 2 on)	16	Zone 113 (Switches 2, 3 & 4 on)	102
Zone 25 (Switches 1 & 2 on)	17	Zone 121 (Switches 1, 2, 3 & 4 on)	103
Zone 33 (Switch 3 on)	18	Zone 129 (Switch 5 on)	104
Zone 41 (Switches 1 & 3 on)	19	Zone 137 (Switches 1 & 5 on)	105
Zone 49 (Switches 2 & 3 on)	20	Zone 145 (Switches 2 & 5 on)	106
Zone 57 (Switches 1, 2 & 3 on)	21	Zone 153 (Switches 1, 2 & 5 on)	107
Zone 65 (Switch 4 on)	96	Zone 161 (Switches 3 & 5 on)	108
Zone 73 (Switches 1 & 4 on)	97	Zone 169 (Switches 1, 3 & 5 on)	109
Zone 81 (Switches 2 & 4 on)	98	Zone 177 (Switches 2, 3 & 5 on)	110
Zone 89 (Switches 1, 2 & 4 on)	99	Zone 185 (Switches 1, 2, 3 & 5 on)	111

REMOTE POWER SUPPLY (NX-320E)

Switch Setting	Address
All switches off	84
Switch 1 on	85
Switch 2 on	86
Switch 1 & 2 on	87
Switch 3 on	88
Switch 1 & 3 on	89
Switch 2 & 3 on	90
Switches 1, 2, & 3 on	91

WIRELESS RECEIVER (NX-448E)

Switch Setting	Expander # reported
All switches off	35
Switch 1 on	36
Switch 2 on	37
Switches 1 & 2 on	38
Switch 3 on	39
Switches 1 & 3 on	32
Switches 2 & 3 on	33
Switch 1, 2 & 3 on	34

OUTPUT MODULE (NX-508E)

Switch Setting	Address	Switch Setting	Address
Switch 1 & 2 on	24	Switch 1,2,&3 on	28
Switch 3 on	25	All switches off	29
Switch 1 & 3 on	26	Switch 1 on	30
Switch 2 & 3 on	27	Switch 2 on	31

XVIII. APPENDIX 4

USER ID OR ZONE ID HEX DIGIT FOR 4+2 FORMATS

The following appendix applies only to slow formats (locations 56- 83 lower digit). The digit programmed in the locations will be sent as the upper HEX digit in place of the alarm event code. The zone ID or user ID will always be reported as the lower HEX digit (1-F) as shown in the chart below. For example, if the zone ID or user ID is 15, the 4+2 lower digit will be "F" and if the zone ID or user ID is 166, the 4+2 digit will be "1". Use the chart shown below for convenience. **NOTE:** If Segments 2-8 are left as "0" (unprogrammed), they will follow the Segment 1 selection. If Segment 1 is left as "0" and the feature is enabled in Location 23, the NX-8E will report "A".

ZONE USER	HEX	ZONE USER	HEX	ZONE USER	HEX	ZONE USER	HEX	ZONE USER	HEX	ZONE USER	HEX
1	1	41	B	81	6	121	1	161	B	201	6
2	2	42	C	82	7	122	2	162	C	202	7
3	3	43	D	83	8	123	3	163	D	203	8
4	4	44	E	84	9	124	4	164	E	204	9
5	5	45	F	85	A	125	5	165	F	205	A
6	6	46	1	86	B	126	6	166	1	206	B
7	7	47	2	87	C	127	7	167	2	207	C
8	8	48	3	88	D	128	8	168	3	208	D
9	9	49	4	89	E	129	9	169	4	209	E
10	A	50	5	90	F	130	A	170	5	210	F
11	B	51	6	91	1	131	B	171	6	211	1
12	C	52	7	92	2	132	C	172	7	212	2
13	D	53	8	93	3	133	D	173	8	213	3
14	E	54	9	94	4	134	E	174	9	214	4
15	F	55	A	95	5	135	F	175	A	215	5
16	1	56	B	96	6	136	1	176	B	216	6
17	2	57	C	97	7	137	2	177	C	217	7
18	3	58	D	98	8	138	3	178	D	218	8
19	4	59	E	99	9	139	4	179	E	219	9
20	5	60	F	100	A	140	5	180	F	220	A
21	6	61	1	101	B	141	6	181	1	221	B
22	7	62	2	102	C	142	7	182	2	222	C
23	8	63	3	103	D	143	8	183	3	223	D
24	9	64	4	104	E	144	9	184	4	224	E
25	A	65	5	105	F	145	A	185	5	225	F
26	B	66	6	106	1	146	B	186	6	226	1
27	C	67	7	107	2	147	C	187	7	227	2
28	D	68	8	108	3	148	D	188	8	228	3
29	E	69	9	109	4	149	E	189	9	229	4
30	F	70	A	110	5	150	F	190	A	230	5
31	1	71	B	111	6	151	1	191	B	231	6
32	2	72	C	112	7	152	2	192	C	232	7
33	3	73	D	113	8	153	3	193	D	233	8
34	4	74	E	114	9	154	4	194	E	234	9
35	5	75	F	115	A	155	5	195	F	235	A
36	6	76	1	116	B	156	6	196	1	236	B
37	7	77	2	117	C	157	7	197	2	237	C
38	8	78	3	118	D	158	8	198	3	238	D
39	9	79	4	119	E	159	9	199	4	239	E
40	A	80	5	120	F	160	A	200	5	240	F

XIX. TELEPHONE COMPANY INTERFACE INFORMATION

TELEPHONE CONNECTION REQUIREMENTS

Except for telephone company provided ringers, all connections to the telephone network shall be made through standard plugs and standard telephone company provided jacks or equivalent in such a manner as to allow for immediate disconnection of the terminal equipment. Standard jacks shall be so arranged that if the plug connected thereto is withdrawn, no interference to the operation of the equipment at the customer's premises, which remains connected to the telephone network, shall occur by reason of such withdrawal.

INCIDENCE OF HARM

Should terminal equipment or protective circuitry cause harm to the telephone network, the telephone company shall, where practical, notify the customer that temporary discontinuance of service may be required. However, where prior notice is not practical, the telephone company may temporarily discontinue service if such action is deemed reasonable in the circumstances. In the case of such temporary discontinuance, the telephone company shall promptly notify the customer who will be given the opportunity to correct the situation. The customer also has the right to bring a complaint to the FCC if he feels the disconnection is not warranted.

CHANGES IN TELEPHONE COMPANY EQUIPMENT OR FACILITIES

The telephone company may make changes in its communications facilities, equipment, operations, or procedures where such action is reasonably required and proper in its business. Should any such change render the customers terminal equipment incompatible with the telephone company facilities, the customer shall be given adequate notice to make modifications to maintain uninterrupted service.

GENERAL

The FCC prohibits customer-provided terminal equipment to be connected to party lines.

IMPORTANCE OF THE RINGER EQUIVALENCE NUMBER

The Ringer Equivalence Number (REN) of this device is 0.1B. This number is a representation of the electrical load that it applies to your telephone line.

MALFUNCTION OF THE EQUIPMENT

In the event that the device should fail to operate properly, the customer shall disconnect the equipment from the telephone line to determine if it is the customers' equipment that is not functioning properly. If the problem is with the device, the customer shall discontinue use until it is repaired.

EQUIPMENT INFORMATION

MANUFACTURER OF CONNECTING EQUIPMENT: **CADDX CONTROLS, INC.**
FCC REGISTRATION NUMBER: GCQUSA-31771-AL-T, RINGER EQUIVALENCE: 0.1 B

INDUSTRY CANADA INFORMATION

NOTICE: The Industry Canada label identifies certified equipment. This certification means that the equipment meets telecommunications network protective, operational and safety requirements as prescribed in the appropriate Terminal Equipment Technical Requirements document(s). The Department does not guarantee the equipment will operate to the user's satisfaction.

Before installing this equipment, users should ensure that it is permissible to be connected to the facilities of the local telecommunications company. The equipment must also be installed using an acceptable method of connection. The customer should be aware that compliance with the above conditions might not prevent degradation of service in some situations.

Repairs to certified equipment should be coordinated by a representative designated by the supplier. Any repairs or alternations made by the user to this equipment, or equipment malfunctions, may give the telecommunications company cause to request the user to disconnect the equipment.

Users should ensure for their protection that the electrical ground connections of the power utility, telephone lines and internal metallic water pipe system, if present, are connected together. This precaution may be particularly important in rural areas.

Caution: Users should not attempt to make such connections themselves, but should contact the appropriate electrical inspection authority, or electrician, as appropriate.

The Ringer Equivalence Number (REN) of this device is 0.1B. This number is a representation of the electrical load that it applies to your telephone line. **NOTICE:** The Ringer Equivalence Number (REN) assigned to each terminal device provides an indication of the maximum number of terminals allowed to be connected to a telephone interface. The termination on an interface may consist of any combination of devices subject only to the requirement that the sum of the Ringer Equivalence Numbers of all the devices does not exceed 5.

XX. NOTICES

(Applies to products which have the CE mark attached)

DECLARATION OF CONFORMITY

Manufacturer's Name: Caddx Controls
Manufacturer's Address: 1420 North Main Street
Gladewater Texas 75647

EU Representative: Interlogix Europe

Product Identification

Product: NetworX
Model Numbers: NX-8E
Brand: CADDX

R&TTE Directive

See EMC and LVD tests below

EMC Directive

EN50081-1
EN50130-4
EN55022
EN60950
EN61000-3-2
EN61000-3-3

LVD Directive

EN 60950: 1999-4 3rd edition

Means of Conformity

We declare under our sole responsibility that this product is in conformity with Directive 1999/5/EC (R&TTE); Directive 73/23/EEC (LVD); and Directive 89/336/EEC (EMC) and based on test results using (non)-harmonized standards in accordance with the Directives mentioned.

Additional Tests

This equipment has been tested and found to comply with the following standards (which are no longer required for compliance).

Network Compatibility Declaration

We declare under our sole responsibility that this product is designed to work with the networks in the countries marked with a check (✓) and may have interworking problems with the countries that are not checked. Due to the inherent differences in the individual PSTNs, certain software settings may need to be adjusted on a country-to-country basis. If it is desired to use this equipment on a network other than the one on which it was originally installed, you should contact your equipment supplier.

<input checked="" type="checkbox"/> Austria	<input type="checkbox"/> Liechtenstein
<input checked="" type="checkbox"/> Belgium	<input checked="" type="checkbox"/> Luxembourg
<input checked="" type="checkbox"/> Denmark	<input checked="" type="checkbox"/> Netherlands
<input checked="" type="checkbox"/> Finland	<input checked="" type="checkbox"/> Norway
<input checked="" type="checkbox"/> France	<input checked="" type="checkbox"/> Poland
<input checked="" type="checkbox"/> Germany	<input checked="" type="checkbox"/> Portugal
<input checked="" type="checkbox"/> Greece	<input checked="" type="checkbox"/> Spain
<input checked="" type="checkbox"/> Iceland	<input checked="" type="checkbox"/> Sweden
<input checked="" type="checkbox"/> Ireland	<input checked="" type="checkbox"/> Switzerland
<input checked="" type="checkbox"/> Italy	<input checked="" type="checkbox"/> United Kingdom

Telecom Approval Notice

This equipment has been approved in accordance with the Council Decision 98/482/EC for pan-European, single terminal connection to the public switched telephone network (PSTN). However, due to the differences between the individual PSTNs provided in different countries, the approval does not, of itself, give an unconditional assurance of successful operation on every PSTN network termination point. In the event of problems, you should contact your equipment supplier in the first instance.

Electrical Requirements

This device automatically adjusts to voltages within the range of **230 V 50/60 Hz**.
Fuse: **Type T 200mA 250 VAC**

XXI. UNDERWRITERS LABORATORIES INFORMATION

The NetworX NX-8E holds the following listings from Underwriters Laboratories (US and Canadian):

UL609 CAN/ULC-S303-M91	Local Grade A Mercantile, Police Station Connect with Basic Line Security * requires #NX-003-C enclosure
UL985 CAN/ULC-S545-M89	Household Fire
UL1023 ORD-C1023-1974	Household Burglary
UL1610 CAN/ULC-S304-M88	Grade B & C Central Station Burglar Alarm Unit
UL1637	Home Health Care Signaling

WHEN INSTALLING AN NX-8E IN COMPLIANCE WITH UNDERWRITERS LABORATORIES, THE FOLLOWING INSTRUCTIONS MUST BE OBSERVED:

- Initiating and indicating devices must be rated at 11.5 to 12.4 V DC residential, 12.0 V DC commercial.
- When using partitioning in Commercial Burglary applications, the main control must be protected by a 24-hour alarm circuit.
- Force Arming and Auto Arming shall not be enabled.
- For residential fire applications, the indicating devices shall be a Wheelock 34T-12 or equivalent.
- The "Listen-In" feature shall not be enabled.
- The Siren/Bell Test shall be enabled. The auxiliary outputs controlling the audible device require a minimum cutoff time of 15 minutes for commercial burglary, 4 minutes for residential applications, or 30 minutes for Commercial Burglary for Canada.
- For residential fire installations, the Dynamic Battery Test time cannot exceed four (4) hours.
- Ringback shall be enabled on UL commercial burglary installations.
- On commercial burglary installations, the fire initiating circuits shall not be connected.
- The Entry-Guard feature shall be disabled.
- Group Bypassing shall be disabled.
- Total current draw from aux power connections at terminal positions POS, AUX PWR, and SMOKE PWR must not exceed 400 mA.
- Remote Downloading shall not be used on UL listed systems.
- For residential burglary applications, the maximum entry and exit delay times shall be 45 and 60 seconds respectively. The exit delay time shall not exceed 60 seconds for commercial burglar alarm applications.
- The keyswitch option shall not be used.
- The telephone line monitor shall be enabled.
- The Telephone Line Cut delay shall not exceed 90 seconds.
- 24-hour communicator test transmission is required.
- For 24 hours of standby power using a 7.0 AH battery, limit auxiliary power load to 140 mA.
- For 24 hours of standby power using a 17.2 AH battery, limit auxiliary power load to 400 mA.
- The silent keypad option shall not be enabled.
- UL has only verified compatibility with the following listed DACRs and formats: Sure-Gard SG-MLR2-DG: 2,9,10,12,13,14; Silent Knight 9000 - 2,12; FBI - CP220FBI, 13; and Ademco 685: 2,11,12, and 13.
- For burglary installations, cross-zoned detectors shall overlap 100 percent in the area of coverage and similar coverage areas must be used. For example, interior protection is cross-zoned with interior protection, and so on.
- Expander trouble must activate the siren (Loc. 37, Segment 2, LED 2)
- For UL 1637, expander trouble must activate keypad sounder (Loc. 39, Segment 1, LED 8)
- If the Late to Close/Early to Open feature is enabled, the Opening and Closing reports shall be enabled (Loc. 23, Seg. 4, Option 1 and Loc. 23, Seg. 3, Option 1).
- For Canadian installations, the class II transformer secure tab shall not be employed.

MINIMUM SYSTEM CONFIGURATIONS FOR UL INSTALLATIONS **(Residential Fire, Residential Burglary, Commercial Burglary)**

- The NetworX NX-8E panel is necessary to initiate Residential and Commercial installations.
- At least one compatible keypad is needed for all applications.
- At least one bell fixture is required for all applications, except Grade C Central Station. For Grade A Local, the AD10-12 bell and Grade A bell housing shall be used.
- Commercial UL applications require #NX-003-C metal enclosure. Supplied screws to be used.
- A minimum of two (2) keypads is required for Home Health applications and each keypad must be set to a unique address.
- The wireless devices are only UL listed for residential applications.
- The DACT shall be enabled for all commercial burglary applications.

STANDBY TIME	TOTAL AUXILIARY CURRENT	STANDBY BATTERY CAPACITY	ALARM CURRENT
24 hours	1.9 Amps	51 AH	600 mA
	1.25 Amps	34 AH	1 Amp
	600 mA	17 AH	1 Amp
48 hours	900 mA	51 AH	1 Amp
	600 mA	34 AH	1 Amp
	300 mA	17 AH	1 Amp
72 hours	600 mA	51 AH	1 Amp
	400 mA	34 AH	1 Amp
	200 mA	17 AH	1 Amp

- Calculations based on three 17-Amp batteries.

XXII. SIA SYSTEM REQUIREMENTS (ANSI / SIA CP-01)

Important Note: UL requirements take priority over SIA requirements

To meet SIA CP-01 requirements –

- Minimum System Requirements: 1 control panel; 2 keypads (or 1 keypad per partition for multi-partitioned systems)
- Remote arming shall NOT be enabled in SIA classified installations.
- Off-premise transmission must be in the SIA format.
- The Abort window and Entry Delay must not exceed 1 minute.
- CAUTION – A call waiting cancel on a non-call waiting line will prevent successful connection to the central station.

CP-01 Feature Description	Feature Description as shown in manual	Program Loc	Seg / Opt	Factory Default	CP-01 Required Setting
Exit Time	Exit 1 Delay	24	2	60	45 – 240 sec.
	Exit 2 Delay	24	4	60	45 – 240 sec.
Progress Annunciation / Disable – for Silent Exit	Silent Keypad Option	* 9 3	2	All annunciators enabled	Allowed (individual keypads may be disabled)
Exit Time Restart	This feature is non-programmable in the panel.				Enabled
Auto Stay Arm on Unvacated Premises	Auto Bypass	23	1 / 3	Enabled	Enabled
Exit Time and Progress Annunciation / Disable – for Remote Arm	This feature is non-programmable in the panel. -- Exit time and progress are always enabled.				Enabled (may be disabled for remote arming)
Entry Delay(s)	Entry 1 Delay	24	1	30	30 – 240 sec.
	Entry 2 Delay	24	3	30	30 – 240 sec.
Abort Window – for Non-Fire Zones	Dialer Delay	40	8	30	Enabled (may be disabled by zone/ zone type)
Abort Window Time – for Non-Fire Zones	Dialer Delay	40	8	30	15 – 45 sec.
Abort Annunciation	This feature is non-programmable in the panel. -- Flashing Cancel LED goes off when disarming.				Enabled
Cancel Annunciation	Cancel	23	3 / 6	Enabled	Enabled
Duress Feature	Duress	44		Disabled	Disabled
Cross Zoning	2 Trips on Cross Zone	37	5 / 4	Disabled	Required
	Keypad sounds on Cross Zone trip	39	5	Disabled	
	Zone Type Characteristic	111	3 / 4	Disabled	
Programmable Cross Zoning Time	Cross Zone Time	40	6	5 minutes	Allowed
Swinger Shutdown	Swinger Shutdown Count	38	n/a	Enabled for 1 trip	For all non-fire zones, shut down at 1–2 trips
Swinger Shutdown Disable	Swinger Shutdown Count	38	n/a	Enabled for 1 trip	Allowed
Fire Alarm Verification	Fire Alarm Verification Time	40	9	Disabled	Required (depends on panel & sensors)
Call Waiting Cancel	Must be programmed as part of the phone number	0	n/a	n/a	Required (depends on user phone line)
<i>Default Changes (from prior versions):</i>	Recent Closing	23	3 / 7	Enabled	
	Exit Error	23	3 / 8	Enabled	
	Power Up Delay	40	3	60 sec.	

NOTE:
Combined Abort window and Entry Delay must not exceed 1 minute.

XXIII. SPECIFICATIONS

OPERATING POWER	16.5 VAC, 40 or 50 VA Transformer
AUXILIARY POWER w/40 or 50 VA Transformer w/NX-320E Power Supply	12 VDC Regulated 2 AMP 12 VDC Regulated 2 AMPS + Control Panel Power
LOOP RESISTANCE Standard Loop 2-Wire Smokes	300 Ohms Maximum 30 Ohms Maximum
BUILT-IN SIREN DRIVER	2-tone (Temporal and Yelp)
LOOP RESPONSE	Selectable 50mS or 500mS
OPERATING TEMPERATURE	32 to 120 degrees F
LED KEYPAD Current Draw Zones Normal w/o Sounder Dimensions	130 mA max. 55 mA 6.4" Wide 4.0" High 1.1" Deep
NX-148E LCD KEYPAD Current Draw w/o Sounder Dimensions	110 mA max. 75 mA 6.4" Wide 5.3" High 1.0" Deep
METAL ENCLOSURE DIMENSION	11.25" Wide 11.25" High 3.50" Deep
SHIPPING WEIGHT	9 lbs.



1420 NORTH MAIN STREET
GLADEWATER, TEXAS 75647

Main
Outside the US
Main Fax

800-727-2339
903-845-6941
903-845-6811

Technical Support
Sales & Literature
www.gesecurity.com

888-437-3287
800-547-2556