

SPACE REQUIREMENTS AND PLANNING

Front Figure

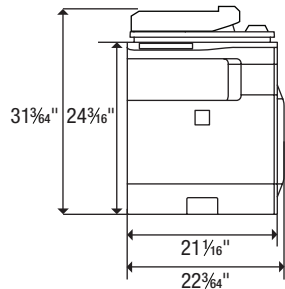

Main Unit + Paper Feed Unit 2

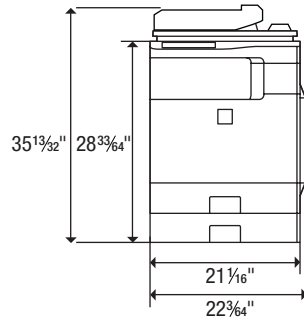

Main Unit + Paper Feed Unit 2 + Stackable Cabinet + Base Plate

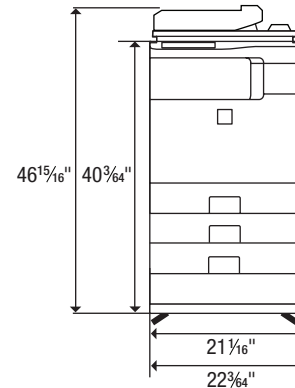

Main Unit + Paper Feed Unit 2 + 3 + 4 + Base Plate

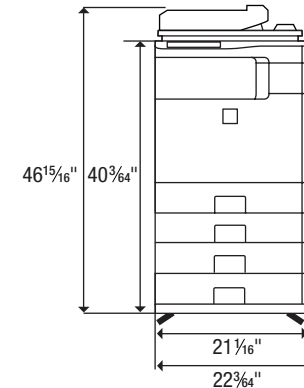

1 Main Unit + Inner Finisher

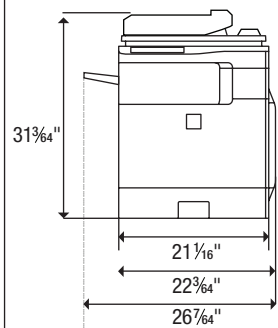

2 Overhead view

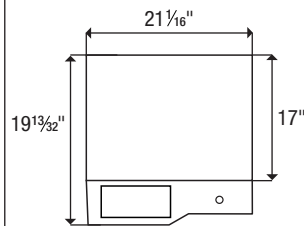

3

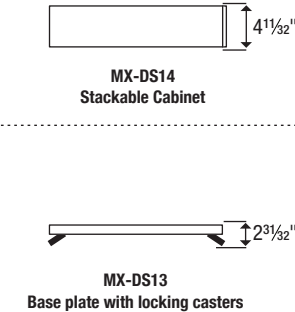

Plan ahead to ensure your installation is a great success! Check the latest information on these products and have the following items available prior to installation.

- Verify power dedication and check for power stability. The MX-C402SC/MX-B402SC Document Systems require AC 100-127 VAC, 60 HZ, 12 Amps power source.
- Confirm that you have the latest firmware available to upgrade your MX-C402SC/MX-B402SC Document System immediately.
- Some accessories require a product key for operation. You should obtain the accessory Application Code, machine's serial number and register online prior to arrival.
- Verify that the customer has enough supplies on-hand to complete a large rush job. After-hours printing and/or holiday work may take place following an installation.

MX-C402SC

MX-C40NTB Black Toner
 MX-C40NTC Cyan Toner
 MX-C40NTM Magenta Toner
 MX-C40NTY Yellow Toner

MX-C40NVB Black Developer
 MX-C40NVC Cyan Developer
 MX-C40NVM Magenta Developer
 MX-C40NVY Yellow Developer

MX-C40NRB Black Drum
 MX-C40NRS Color Drum
 (Cyan/Magenta/Yellow)
 (requires one per color)

MX-B402SC

MX-B42NT1 Black Toner

MX-B42NV1 Black Developer

MX-C40NRB Black Drum

- Check to see if My Sharp™ online training is set up for the end-user.



Design and specifications are subject to change without notice. All product dimensions listed are approximate. Sharp, My Sharp and all related trademarks are trademarks or registered trademarks of Sharp Corporation and/or affiliated companies. PCL® is a registered trademark of Hewlett-Packard Company and PostScript® is a registered trademark of Adobe Systems Inc. All other trademarks are the property of their respective owners.

For complete installation procedures please contact your Authorized Sharp servicing dealer.

PRODUCT CONFIGURATION

MX-C402SC/MX-B402SC — 8.5" (MX-C402SC)/7" (MX-B402SC) W-VGA Color Touch Panel, 1 GHz (MX-C402SC)/800 MHz (MX-B402SC) multitasking controller, 80 GB hard drive with document filing system, retractable QWERTY keyboard, PCL® 5e / PCL 6 / PostScript® 3 network printing, Scan² single-pass dual-sided color scanning, network scanning, 100-sheet double-sided single-pass feeder, auto duplexing, one 500-sheet paper drawer and 100-sheet bypass tray, Sharp OSA® technology – Application Communication & External Accounting modules. **MX-C402SC:** Includes developer and drums. Toner cartridges sold separately. **MX-B402SC:** Drum included. Toner and developer sold separately.

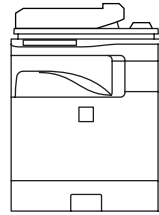

MX-C402SC/MX-B402SC
Multifunctional Digital Document System

1 CHOOSE CONFIGURATION TYPE

CABINET-TOP CONFIGURATION

OR

FLOOR STANDING CONSOLE CONFIGURATION

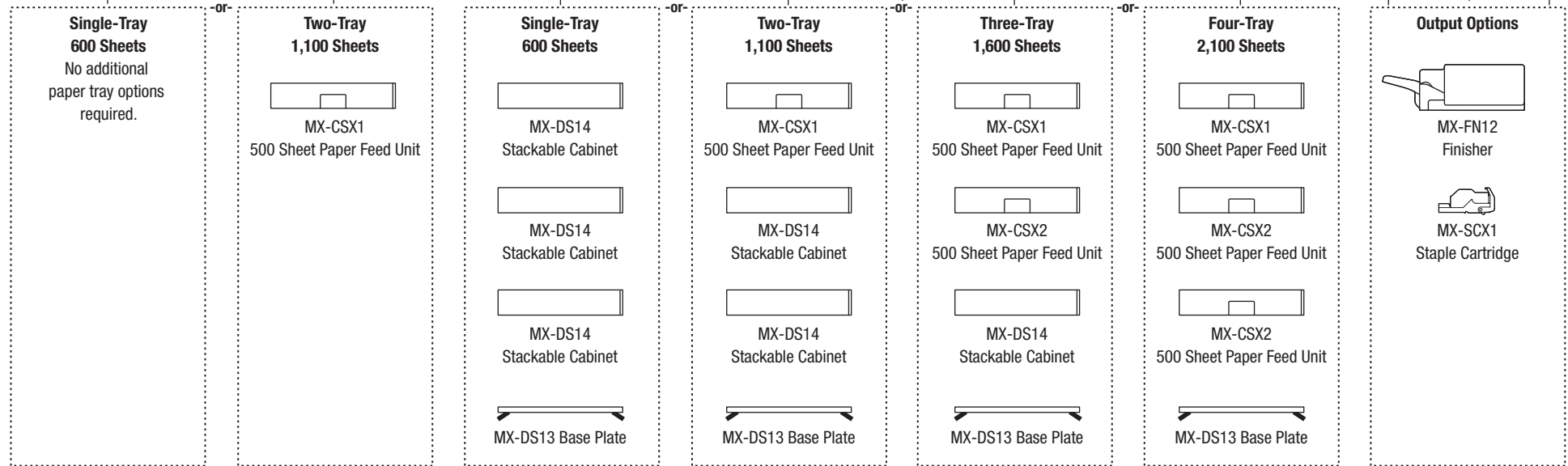

3 CHOOSE CONNECTIVITY OPTIONS

