

PRODUCT CONFIGURATION

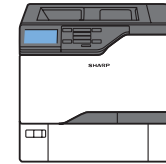

MX-C507P
Desktop Printer
Single Drawer (included)

MX-C507P Printer

Base model includes 4.3 inch color touch screen, wired connectivity, PCL 5e/6/XL, PostScript 3™ printing system, auto duplexing 1 x 550 sheet paper drawer, 100 sheet bypass tray. Includes toner (starter size 7K each) and developer included.

CHOOSE PAPER FEED OPTIONS

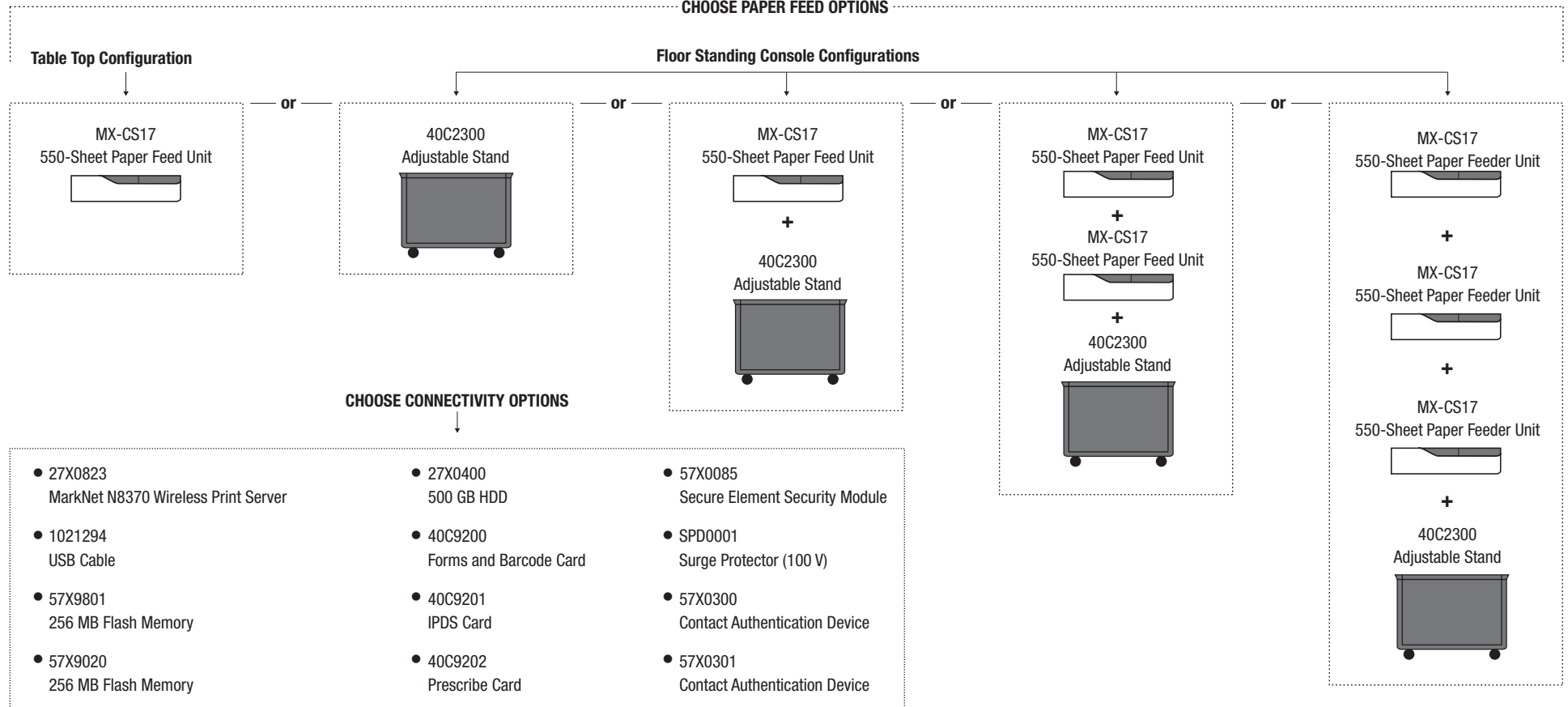

SPACE REQUIREMENTS AND PLANNING

MX-C507P
(standard drawer,
table top)
650-sheet maximum

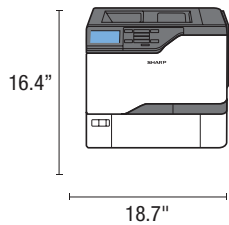

MX-C507P+ MX-CS17
(1 additional drawer,
table top)
1,200-sheet maximum

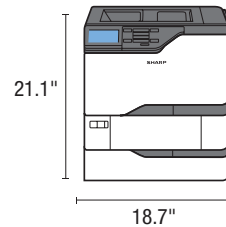

MX-C507P+ 40C2300
(standard drawer,
low floor standing)
650-sheet maximum

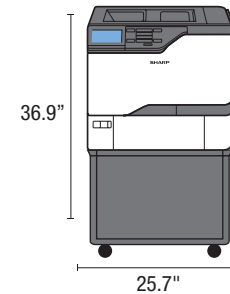

**MX-C507P+
2 x MX-CS17 + 40C2300**
(2 additional drawers,
floor standing)
1,750-sheet maximum

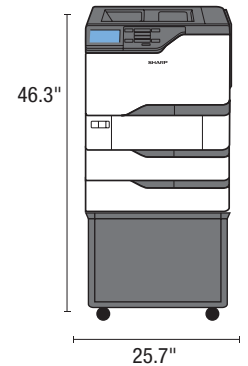

Overhead View with Stand

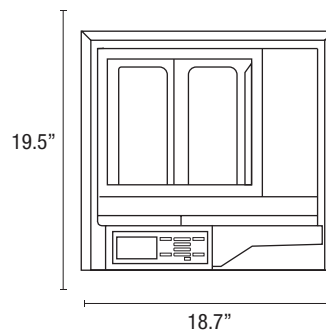

Design and specifications are subject to change without notice. All product dimensions listed are approximate.

Plan ahead to ensure your installation is a great success! Check the latest information on these products and have the following items available prior to installation.

- **Firmware:** Check the Sharp-PC Service site to make sure the machine and accessories have the latest firmware prior to installation at the customer site.
- **Power Source:** Verify the power source at the customer site. Requires 110-127 V AC @ 60 HZ with a 15 A receptacle outlet and circuit breaker.
- **Product Keys:** Obtain application codes for any accessories that may require a product key prior to arrival at the customer site.
- **Supplies:** Verify that the customer has enough supplies on hand. Starter toner included.

MX-C51TB Black Toner Cartridge

MX-C51TC Cyan Toner Cartridge

MX-C51TM Magenta Toner Cartridge

MX-C51TY Yellow Toner Cartridge

MX-C50DU-B Black Imaging Kit (includes drum/developer)

MX-C50DU-S Cyan/Magenta/Yellow (includes drum/developer)