

INSTALLATION INSTRUCTIONS

1 Install Track

Center track in opening width. Backset the front edge of track 1/2" from desired location of door face. Fasten track with screws provided. For 2 panel doors, position track with the track socket closest to jamb to which doors will open. Be sure tracks are in line & plumb.

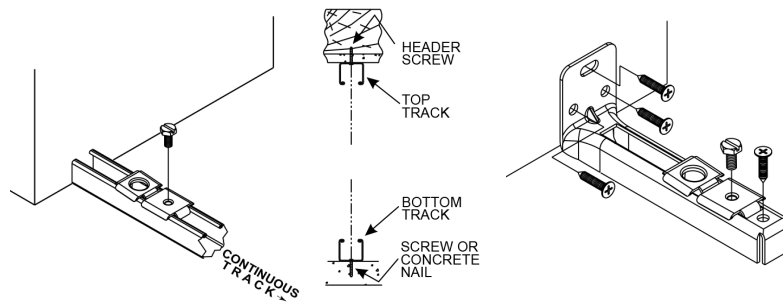

Optional Bottomless Track Bracket

For optional bottomless track bracket, set bracket on floor directly below top track. Fasten bracket to the wall using three #10 x 1 1/4" pan head screws. Secure to floor using a #10 x 1 1/4" pan head screw.

2 Adjustable Lower Pivot

Lay metal door face down on a surface that will not damage the door face. Locate the adjustable lower pivot assembly. Loosen the rod clamp screw and screw adjustable lower pivot until nylon bushing is approximately 1/4" below the bottom of the door.

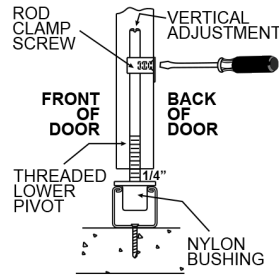

3 Installation

Lift one panel set into opening and insert adjustable lower pivot into bottom track socket. Center top spring guide under top track socket and tap guide until it releases into socket. Center remaining guides above and below track groove and tap guides to release into track.

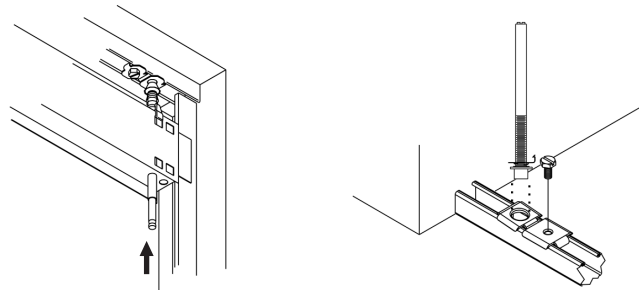

4 Adjustment

To make tops of doors parallel to top track, begin adjustment with doors in closed position. Loosen the upper or lower track sockets and slide in desired direction. To make the height of the panels even, raise or lower doors by adjusting the adjustable lower pivot in desired direction. Be sure to tighten the rod clamp assembly when adjustments are complete.

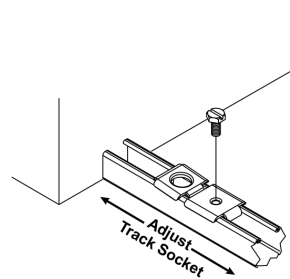

Be sure to tighten the rod clamp assembly when adjustments are complete.

5 Attach Handle

If predrilled hole exists, insert the screw from the back side of the door and positively fasten the handle from the front. If hole does not exist, using a metal drill bit, drill a 3/16" hole in the proper location based on the door type as illustrated below.

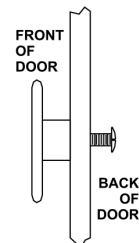
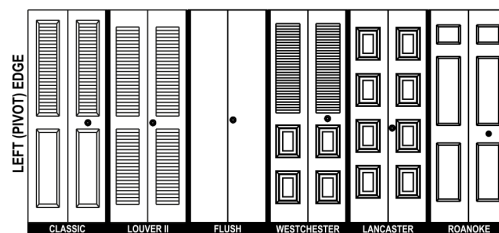

6 Track Bumpers

Track bumpers are used to lightly tension the door to keep it in the closed position. The track bumpers are self centering and are pre-installed in the top and bottom tracks.

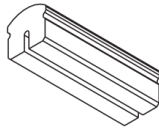

7 Plastic Bumpers

The self adhesive plastic bumpers may be used between the panels to fine tune panel alignment. They may be moved up, down, in, or out to achieve proper alignment.

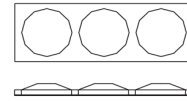

8 Changing handing on 2 Panel Units

To change the handing on a 2 panel door, lay the metal door face down on a surface that will not damage the door face. Move the adjustable lower pivot from the inside hole on one side to the inside hole on opposite side of the door. Move the bottom spring loaded guide from outside hole to outside hole on opposite side. Move the top spring guides over one hole location to match the bottom adjustable lower pivot and spring guide setup.

