

The ACC closet system can be used in any room in the home or office. The configurations are limited only by your professional knowledge and imagination. Closets, pantries, store rooms and garage storage systems are only a few of the possible applications for this product when finished ends and no back are required.

All pricing is based upon 3/4" white, two sided, fused melamine with 1mm thick, white PVC edge banding on three sides of panels and four sides of doors and drawer fronts. Doors and drawer fronts can be upgraded to 3mm PVC edge banding which is available in a variety of colors to customize your installation.

INSTALLATION INSTRUCTIONS

1. MEASURE AND CUT WALL RAIL TO LENGTH OF INSTALLATION AS NECESSARY.
2. FASTEN WALL RAIL TO EACH WALL STUD AT THE PROPER HEIGHT ABOVE FLOOR FOR YOUR SPECIFIC PANEL LENGTH WITH A 2 1/2 - 3" GRABBER SCREW. MAKE SURE THAT THE RAIL IS LEVEL.
3. INSTALL HANGING BRACKET IN PRE BORED 5mm HOLES AT TOP OF EACH PANEL. INSTALL CONNECTING SCREWS OR DOUBLE ENDED BOLTS FOR FIXED SHELVES ON CENTER PANELS (CCP). ATTACH DRAWER SLIDES TO PANELS IF APPLICABLE.
4. HANG FIRST END PANEL ON THE RAIL (CEL or CER). PLACE CENTER PANELS IN APPROXIMATE LOCATION, INSERT FIXED SHELF CAM AND TWIST CAM WITH SCREWDRIVER TO SECURE BOTH PANELS. REPEAT PROCESS WITH ALL OTHER FS's IN THAT COLUMN.
5. ADJUST HANGING BRACKETS TO LEVEL AND PLUMB YOUR INSTALLATION.
6. CUT PLASTIC WALL RAIL COVER TO LENGTH AND SNAP ON OVER THE WALL RAIL.
7. SECURE PANELS TO WALL USING CORNER BLOCK. (zip-it drywall anchors come in handy)
8. INSERT ADJUSTABLE SHELF FITTING INTO SHELF EDGE. INSERT SHELF REST INTO SYSTEM HOLES IN PANELS AND PLACE SHELF OVER SHELF REST AND PUSH GENTLY TO SEAT REST INTO FITTING.

PUT YOUR CLOTHES AWAY AND ENJOY!

**ALPHA
CABINET
COMPONENTS**

CLOSET COMPONENT AND HARDWARE DESCRIPTIONS

End Panels & Center Panels, include;

- 1mm white PVC banding on front, top & bottom edges.
- One white epoxy coated Hanging Bracket.
- 5mm System holes to accommodate Drawers, Shelves, Closet Rod, Door Hinge Plates, and other accessories.
- Center Panels are bored through the panel to receive a Double Ended Bolt for fixed shelves, a 15mm or 10mm Euro Screw for Drawer Slides depending on whether they are side by side or not.

PLEASE SPECIFY WHICH LENGTH AND STYLE OF SCREW YOU REQUIRE FOR YOUR INSTALLATION!
ALSO, PLEASE SPECIFY HOW MANY FEET OF WALL RAIL AND RAIL COVER THAT YOU REQUIRE.

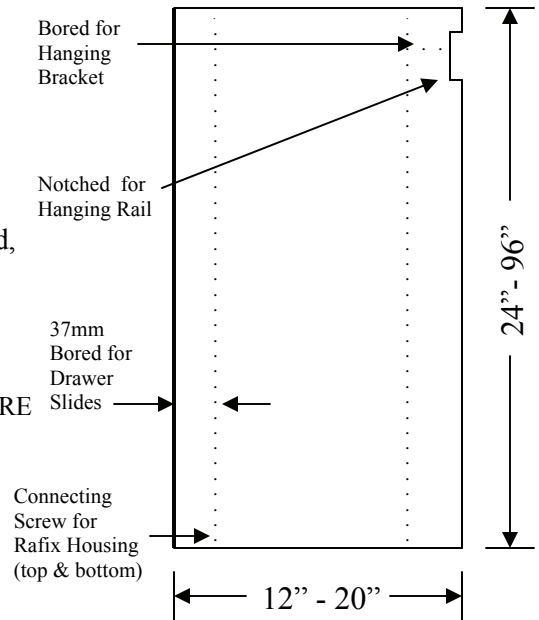

Fixed Shelves & Adjustable Shelves include;

- 1mm white PVC banding on the front edge.
- 20mm holes for Rafix Housing (fixed) or Rasant Tab (adjustable) shelves, with fittings included.
- Rafix and Rasant fittings must be on bottom of shelf or fitting will dislodge from hole when weight is applied.

THE ONLY DIFFERENCE BETWEEN AN FS AND AS IS THE FITTING WHICH INSERTS INTO THE 20mm HOLE.

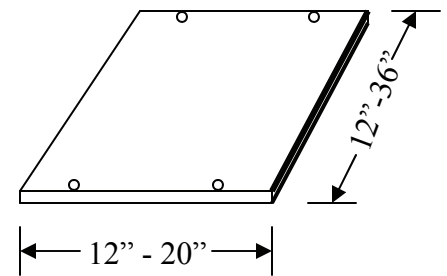

Drawer Boxes with Drawer Fronts include;

- 3/4 inch two sided white melamine drawer box with white .018 inch (0.5mm) PVC banding on top edge, bored for Conformat screw assembly.
- Drawer Boxes come in three heights, 4 inch, 6 inch and 9 inch.
- Corresponding drawer Front heights are 6 1/8 inch, 8 11/16 inch and 11 3/16 inch.
- Drawer Fronts come standard with white 1mm PVC edge and can be upgraded to 3mm PVC of any color.
- Drawers can be put in any location on the system.
- Drawer Fronts overlay panels, and fixed shelves by 7.5mm each side.

The reveals are 11.5mm on the sides, 4mm top & bottom (2mm up & down from center of system hole)

PLEASE SPECIFY THE LENGTH OF DRAWER SLIDES REQUIRED; 20 inch, 18 inch, 16 inch, 14 inch, 12 inch ACCORDING TO YOUR PANEL DEPTH.

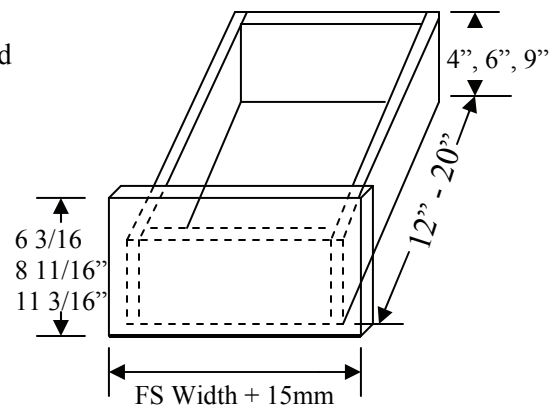

Closet Doors include;

- 3/4 inch two sided white melamine slab door with 1mm white .018 inch (0.5mm) or 3mm PVC edge banding. All doors are pre bored for Blum concealed hinges. Doors can be installed anywhere on the system between fixed or adjustable shelves. Door heights are as follows;
- 18 inch = 476mm - 18 3/4 inch high
- 21 inch = 540mm - 21 1/4 inch high
- 24 inch = 604mm - 23 3/4 inch high
- 27 inch = 668mm - 26 1/4 inch high
- 30 inch = 732mm - 28 13/16 inch high

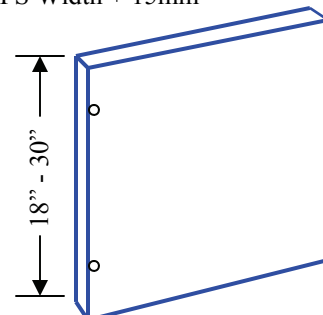

CLOSET ORDER FORM

<u>Company Name:</u>		
<u>Address:</u>		
<u>City:</u>	<u>State:</u>	<u>Zip:</u>
<u>Phone:</u>	<u>Fax:</u>	
<u>Ship To:</u>		
<u>Address:</u>		
<u>City:</u>	<u>State:</u>	<u>Zip:</u>
<u>Date:</u>	<u>Job Name:</u>	

ALL PANELS, SHELVES, DOORS AND DRAWER FRONTS ARE BANDED IN WHITE 1MM PVC
 ALL PANELS ARE BORED FOR DOORS & DRAWERS WITH REVEALS BASED ON THE 32mm SYSTEM IN HEIGHT
 SEE PANEL HEIGHT CHART ON EACH PAGE

Services & Hardware		Qty.
Contact Name:		
8' Closet Rod- 2.00 / ft.		
Rod Supports- 1.35 / pair		
8' Wall Rail - 4.85 / each		
8' Wall Rail Cover - 1.25 each		
Double Ended Bolt - .25 each		
15mm Connecting Screw - .10 / each		
Blum 1/2 Cranked Hinge & Plate - 3.00 ea.		
Blum 230M Drawer Slide 18" - 3.00 / pair		
Blum 230M Drawer Slide 16" - 3.00 / pair		
Blum 230M Drawer Slide 14" - 3.00 / pair		
Blum 230M Drawer Slide 12" - 3.00 / pair		

HANGING BRACKETS, 8MM CONNECTING SCREWS, FIXED AND ADJUSTABLE SHELF FITTINGS ARE INCLUDED IN COMPONENT PRICE. CHECK YOUR LAYOUT FOR CONNECTING SCREW TYPE AND LENGTH CAREFULLY!

	QTY	CEL	QTY	CER	QTY	CCP	QTY	CFS	QTY	CAS
1										
2										
3										
4										
5										
6										
7										
8										
9										
10										
11										
12										
13										
14										

	QTY.	Doors	QTY.	Doors	QTY.	DRW's & DF's	QTY.	DRW's & DF's
1			6		1		6	
2			7		2		7	
3			8		3		8	
4			9		4		9	
5			10		5		10	

**ALPHA
CABINET
COMPONENTS**

20" deep Closet Panels

Panel Heights

Nominal Height	Actual Millimeters	Actual Inches
24"	595mm	23 7/16"
30"	755mm	29 3/4"
36"	915mm	36"
42"	1075mm	42 5/16"
48"	1203mm	47 3/8"
60"	1523mm	59 15/16"
72"	1843mm	72 9/16"
84"	2131mm	83 7/8"
96"	2419mm	95 1/4"

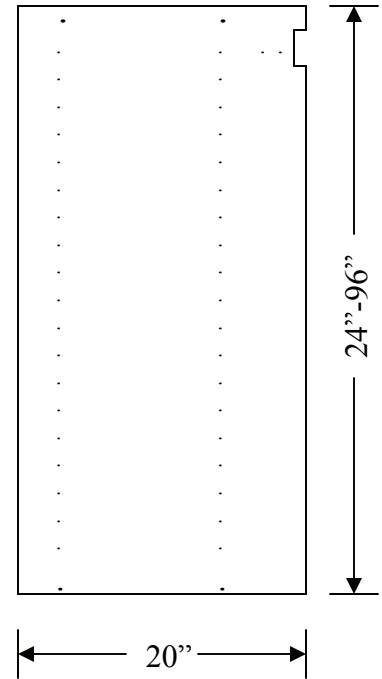

20" Closet End Panels		
CEL 24 20	CER 24 20	12.22
CEL 30 20	CER 30 20	13.51
CEL 36 20	CER 36 20	14.80
CEL 42 20	CER 42 20	16.45
CEL 48 20	CER 48 20	18.10
CEL 60 20	CER 60 20	21.45
CEL 72 20	CER 72 20	24.80
CEL 84 20	CER 84 20	28.15
CEL 96 20	CER 96 20	31.90

20" Closet Center Panels		
CCP 24 20		15.22
CCP 30 20		16.51
CCP 36 20		17.80
CCP 42 20		19.45
CCP 48 20		21.10
CCP 60 20		24.45
CCP 72 20		27.80
CCP 84 20		31.15
CCP 96 20		34.50

20" Closet Fixed & Adjustable Shelves		
CFS 12 20	CAS 12 20	9.02
CFS 15 20	CAS 15 20	9.81
CFS 18 20	CAS 18 20	10.62
CFS 21 20	CAS 21 20	11.43
CFS 24 20	CAS 24 20	12.23
CFS 27 20	CAS 27 20	13.03
CFS 30 20	CAS 30 20	13.84
CFS 33 20	CAS 33 20	14.64
CFS 36 20	CAS 36 20	15.44

**ALPHA
CABINET
COMPONENTS**

Drawer Box & Drawer Fronts

for
20" deep Panels

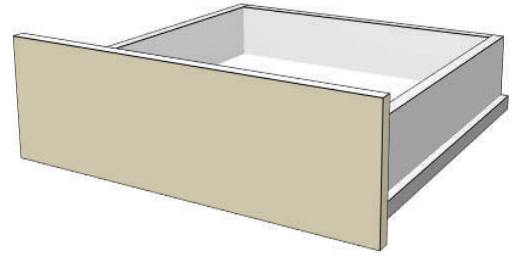

Drawer Front Heights are;

4" DRW = 6 1/8"

6" DRW = 8 11/16"

9" DRW = 11 3/16"

Order Drawer the same width as Fixed

Shelf when ordering non standard widths

Drawer Box and Drawer Front with 1mm Banding

4" high x 20" deep

DRW 12 4 20	15.38
DRW 15 4 20	16.62
DRW 18 4 20	17.84
DRW 21 4 20	19.09
DRW 24 4 20	20.32
DRW 27 4 20	21.57
DRW 30 4 20	22.78
DRW 33 4 20	24.00
DRW 36 4 20	25.25

6" high X 20" deep

DRW 12 6 20	16.81
DRW 15 6 20	18.34
DRW 18 6 20	19.97
DRW 21 6 20	21.70
DRW 24 6 20	23.54
DRW 27 6 20	25.51
DRW 30 6 20	27.59
DRW 33 6 20	29.70
DRW 36 6 20	31.75

9" high x 20" deep

DRW 12 9 20	19.29
DRW 15 9 20	21.16
DRW 18 9 20	23.04
DRW 21 9 20	24.91
DRW 24 9 20	26.79
DRW 27 9 20	28.67
DRW 30 9 20	30.54
DRW 33 9 20	32.50
DRW 36 9 20	34.30

Drawer Box and Drawer Front with 3mm Banding

4" high x 20" deep

DRW 12 4 20-3	20.53
DRW 15 4 20-3	21.82
DRW 18 4 20-3	23.09
DRW 21 4 20-3	24.38
DRW 24 4 20-3	25.66
DRW 27 4 20-3	26.96
DRW 30 4 20-3	28.22
DRW 33 4 20-3	29.50
DRW 36 4 20-3	30.75

6" high x 20" deep

DRW 12 6 20-3	22.04
DRW 15 6 20-3	23.65
DRW 18 6 20-3	25.35
DRW 21 6 20-3	27.15
DRW 24 6 20-3	29.07
DRW 27 6 20-3	31.11
DRW 30 6 20-3	33.27
DRW 33 6 20-3	35.45
DRW 36 6 20-3	37.60

9" high x 20" deep

DRW 12 9 20-3	24.61
DRW 15 9 20-3	26.57
DRW 18 9 20-3	28.55
DRW 21 9 20-3	30.53
DRW 24 9 20-3	32.51
DRW 27 9 20-3	34.49
DRW 30 9 20-3	36.46
DRW 33 9 20-3	38.45
DRW 36 9 20-3	40.45

**ALPHA
CABINET
COMPONENTS**

18" deep Closet Panels

Panel Heights

Nominal Height	Actual Millimeters	Actual Inches
24"	595mm	23 7/16"
30"	755mm	29 3/4"
36"	915mm	36"
42"	1075mm	42 5/16"
48"	1203mm	47 3/8"
60"	1523mm	59 15/16"
72"	1843mm	72 9/16"
84"	2131mm	83 7/8"
96"	2419mm	95 1/4"

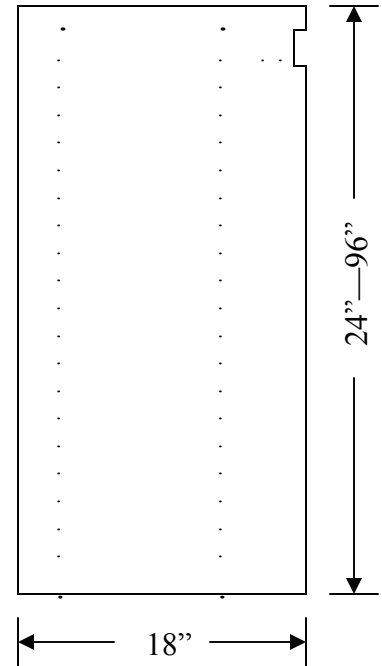

18" Closet End Panels	
CEL 24 18 CER 24 18	10.90
CEL 30 18 CEP 30 18	12.46
CEL 36 18 CER 36 18	14.02
CEL 42 18 CER 42 18	15.58
CEL 48 18 CER 48 18	17.14
CEL 60 18 CER 60 18	20.26
CEL 72 18 CER 72 18	23.38
CEL 84 18 CER 84 18	26.50
CEL 96 18 CER 96 18	29.80

18" Closet Center Panels	
CCP 24 18	13.90
CCP 30 18	15.46
CCP 36 18	17.02
CCP 42 18	18.58
CCP 48 18	20.14
CCP 60 18	23.36
CCP 72 18	26.38
CCP 84 18	29.50
CCP 96 18	32.80

18" Closet Fixed & Adjustable Shelves	
CFS 12 18 CAS 12 18	7.97
CFS 15 18 CAS 15 18	8.76
CFS 18 18 CAS 18 18	9.57
CFS 21 18 CAS 21 18	10.38
CFS 24 18 CAS 24 18	11.18
CFS 27 18 CAS 27 18	11.98
CFS 30 18 CAS 30 18	12.79
CFS 33 18 CAS 33 18	13.60
CFS 36 18 CAS 36 18	14.40

**ALPHA
CABINET
COMPONENTS**

Drawer Box & Drawer Fronts

for
18" deep Panels

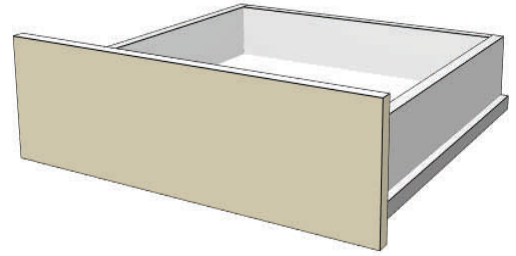

Drawer Front Heights are;

4" DRW = 6 1/8"

6" DRW = 8 11/16"

9" DRW = 11 3/16"

Order Drawer the same width as Fixed

Shelf when ordering non standard widths

Drawer Box and Drawer Front with 1mm Banding

4" high x 18" deep

6" high X 18" deep

9" high x 18" deep

DRW 12 4 18	14.97
DRW 15 4 18	16.17
DRW 18 4 18	17.35
DRW 21 4 18	18.56
DRW 24 4 18	19.75
DRW 27 4 18	20.96
DRW 30 4 18	22.14
DRW 33 4 18	23.35
DRW 36 4 18	24.55

DRW 12 6 18	16.36
DRW 15 6 18	17.85
DRW 18 6 18	19.43
DRW 21 6 18	21.11
DRW 24 6 18	22.89
DRW 27 6 18	24.79
DRW 30 6 18	26.80
DRW 33 6 18	28.82
DRW 36 6 18	30.85

DRW 12 9 18	18.75
DRW 15 9 18	20.57
DRW 18 9 18	22.40
DRW 21 9 18	24.22
DRW 24 9 18	26.05
DRW 27 9 18	27.88
DRW 30 9 18	29.70
DRW 33 9 18	31.55
DRW 36 9 18	33.40

Drawer Box and Drawer Front with 3mm Banding

4" high x 18" deep

6" high x 18" deep

9" high x 18" deep

DRW 12 4 18-3	20.12
DRW 15 4 18-3	21.37
DRW 18 4 18-3	22.60
DRW 21 4 18-3	23.85
DRW 24 4 18-3	25.09
DRW 27 4 18-3	26.35
DRW 30 4 18-3	27.58
DRW 33 4 18-3	28.81
DRW 36 4 18-3	30.05

DRW 12 6 18-3	21.59
DRW 15 6 18-3	23.16
DRW 18 6 18-3	24.81
DRW 21 6 18-3	26.56
DRW 24 6 18-3	28.42
DRW 27 6 18-3	30.39
DRW 30 6 18-3	32.48
DRW 33 6 18-3	34.60
DRW 36 6 18-3	36.70

DRW 12 9 18-3	24.07
DRW 15 9 18-3	25.98
DRW 18 9 18-3	27.91
DRW 21 9 18-3	29.84
DRW 24 9 18-3	31.77
DRW 27 9 18-3	33.70
DRW 30 9 18-3	35.62
DRW 33 9 18-3	37.55
DRW 36 9 18-3	39.50

**ALPHA
CABINET
COMPONENTS**

16" deep Closet Panels

Panel Heights

Nominal Height	Actual Millimeters	Actual Inches
24"	595mm	23 7/16"
30"	755mm	29 3/4"
36"	915mm	36"
42"	1075mm	42 5/16"
48"	1203mm	47 3/8"
60"	1523mm	59 15/16"
72"	1843mm	72 9/16"
84"	2131mm	83 7/8"
96"	2419mm	95 1/4"

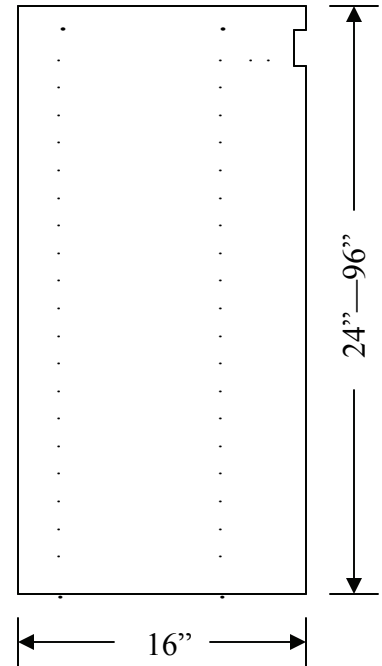

<i>16" Closet End Panels</i>	
CEL 24 16 CER 24 16	10.45
CEL 30 16 CER 30 16	11.90
CEL 36 16 CER 36 16	13.35
CEL 42 16 CER 42 16	14.80
CEL 48 16 CER 48 16	16.25
CEL 60 16 CER 60 16	19.14
CEL 72 16 CER 72 16	22.04
CEL 84 16 CER 84 16	24.94
CEL 96 16 CER 96 16	27.80

<i>16" Closet Center Panels</i>	
CCP 24 30	13.45
CCP 30 16	14.90
CCP 36 16	16.35
CCP 42 16	17.80
CCP 48 16	19.25
CCP 60 16	22.14
CCP 72 16	25.04
CCP 84 16	27.94
CCP 96 16	30.85

<i>16" Closet Fixed & Adjustable Shelves</i>	
CFS 12 16 CAS 12 16	7.72
CFS 15 16 CAS 15 16	8.46
CFS 18 16 CAS 18 16	9.21
CFS 21 16 CAS 21 16	9.95
CFS 24 16 CAS 24 16	10.68
CFS 27 16 CAS 27 16	11.42
CFS 30 16 CAS 30 16	12.16
CFS 33 16 CAS 33 16	12.90
CFS 36 16 CAS 36 16	13.65

**ALPHA
CABINET
COMPONENTS**

Drawer Box & Drawer Fronts

for
16" deep Panels

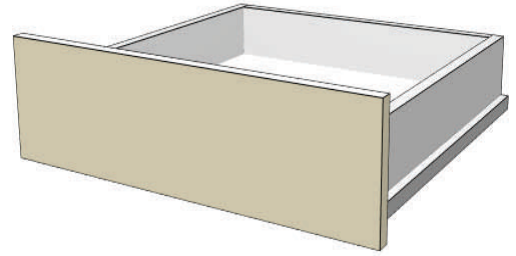

Drawer Front Heights are;

4" DRW = 6 1/8"

6" DRW = 8 11/16"

9" DRW = 11 3/16"

Order Drawer the same width as Fixed

Shelf when ordering non standard widths

Drawer Box and Drawer Front with 1mm Banding

4" high x 16" deep

DRW 12 4 16	14.97
DRW 15 4 16	16.17
DRW 18 4 16	17.35
DRW 21 4 16	18.56
DRW 24 4 16	19.75
DRW 27 4 16	20.96
DRW 30 4 16	22.14
DRW 33 4 16	23.32
DRW 36 4 16	24.50

6" high X 16" deep

DRW 12 6 16	16.36
DRW 15 6 16	17.85
DRW 18 6 16	19.43
DRW 21 6 16	21.11
DRW 24 6 16	22.89
DRW 27 6 16	24.79
DRW 30 6 16	26.80
DRW 33 6 16	28.81
DRW 36 6 16	30.82

9" high x 16" deep

DRW 12 9 16	18.75
DRW 15 9 16	20.57
DRW 18 9 16	22.40
DRW 21 9 16	24.22
DRW 24 9 16	26.05
DRW 27 9 16	27.88
DRW 30 9 16	29.70
DRW 33 9 16	31.52
DRW 36 9 16	33.35

Drawer Box and Drawer Front with 3mm Banding

4" high x 16" deep

DRW 12 4 16-3	20.12
DRW 15 4 16-3	21.37
DRW 18 4 16-3	22.60
DRW 21 4 16-3	23.85
DRW 24 4 16-3	25.09
DRW 27 4 16-3	26.35
DRW 30 4 16-3	27.58
DRW 33 4 16-3	28.80
DRW 36 4 16-3	30.05

6" high x 16" deep

DRW 12 6 16-3	21.59
DRW 15 6 16-3	23.16
DRW 18 6 16-3	24.81
DRW 21 6 16-3	26.56
DRW 24 6 16-3	28.42
DRW 27 6 16-3	30.39
DRW 30 6 16-3	32.48
DRW 33 6 16-3	34.57
DRW 36 6 16-3	36.66

9" high x 16" deep

DRW 12 9 16-3	24.07
DRW 15 9 16-3	25.98
DRW 18 9 16-3	27.91
DRW 21 9 16-3	29.84
DRW 24 9 16-3	31.77
DRW 27 9 16-3	33.70
DRW 30 9 16-3	35.62
DRW 33 9 16-3	37.55
DRW 36 9 16-3	39.50

**ALPHA
CABINET
COMPONENTS**

14" deep Closet Panels

Panel Heights

Nominal Height	Actual Millimeters	Actual Inches
24"	595mm	23 7/16"
30"	755mm	29 3/4"
36"	915mm	36"
42"	1075mm	42 5/16"
48"	1203mm	47 3/8"
60"	1523mm	59 15/16"
72"	1843mm	72 9/16"
84"	2131mm	83 7/8"
96"	2419mm	95 1/4"

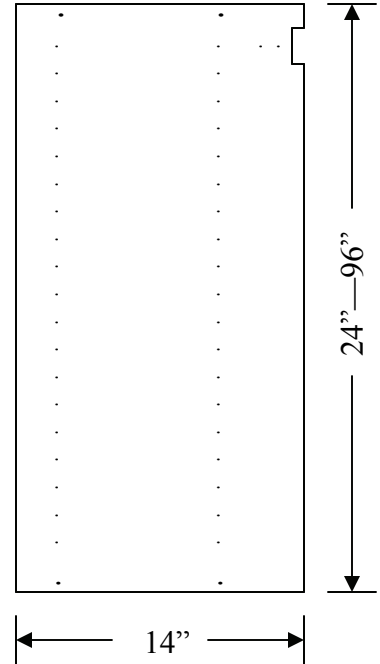

<i>14" Closet End Panels</i>	
CEL 24 14 CER 24 14	10.02
CEL 30 14 CER 30 14	11.35
CEL 36 14 CER 36 14	12.68
CEL 42 14 CER 42 14	14.02
CEL 48 14 CER 48 14	15.36
CEL 60 14 CER 60 14	18.03
CEL 72 14 CER 72 14	20.70
CEL 84 14 CER 84 14	23.38
CEL 96 14 CER 96 14	26.10

<i>14" Closet Center Panels</i>	
CCP 24 14	13.02
CCP 30 14	14.35
CCP 36 14	15.68
CCP 42 14	17.02
CCP 48 14	18.36
CCP 60 14	21.03
CCP 72 14	23.70
CCP 84 14	26.38
CCP 96 14	29.10

<i>14" Closet Fixed & Adjustable Shelves</i>	
CFS 12 14 CAS 12 14	6.77
CFS 15 14 CAS 15 14	7.45
CFS 18 14 CAS 18 14	8.12
CFS 21 14 CAS 21 14	8.81
CFS 24 14 CAS 24 14	9.49
CFS 27 14 CAS 27 14	10.16
CFS 30 14 CAS 30 14	10.84
CFS 33 14 CAS 33 14	11.52
CFS 36 14 CAS 36 14	12.20

**ALPHA
CABINET
COMPONENTS**

Drawer Box & Drawer Fronts

for
14" deep Panels

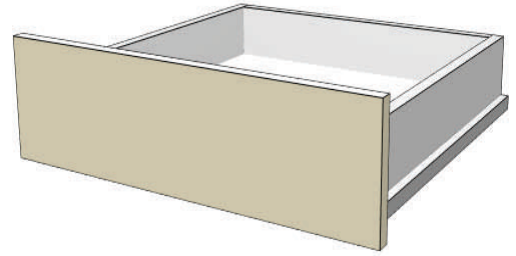

Drawer Front Heights are;

4" DRW = 6 1/8"

6" DRW = 8 11/16"

9" DRW = 11 3/16"

Order Drawer the same width as Fixed

Shelf when ordering non standard widths

Drawer Box and Drawer Front with 1mm Banding

4" high x 14" deep

DRW 12 4 14	14.97
DRW 15 4 14	16.17
DRW 18 4 14	17.35
DRW 21 4 14	18.56
DRW 24 4 14	19.75
DRW 27 4 14	20.96
DRW 30 4 14	22.14
DRW 33 4 14	23.32
DRW 36 4 14	24.50

6" high X 14" deep

DRW 12 6 14	16.36
DRW 15 6 14	17.85
DRW 18 6 14	19.43
DRW 21 6 14	21.11
DRW 24 6 14	22.89
DRW 27 6 14	24.79
DRW 30 6 14	26.80
DRW 33 6 14	28.81
DRW 36 6 14	30.82

9" high x 14" deep

DRW 12 9 14	18.75
DRW 15 9 14	20.57
DRW 18 9 14	22.40
DRW 21 9 14	24.22
DRW 24 9 14	26.05
DRW 27 9 14	27.88
DRW 30 9 14	29.70
DRW 33 9 14	31.52
DRW 36 9 14	33.35

Drawer Box and Drawer Front with 3mm Banding

4" high x 14" deep

DRW 12 4 14-3	20.12
DRW 15 4 14-3	21.37
DRW 18 4 14-3	22.60
DRW 21 4 14-3	23.85
DRW 24 4 14-3	25.09
DRW 27 4 14-3	26.35
DRW 30 4 14-3	27.58
DRW 33 4 14-3	28.80
DRW 36 4 14-3	30.05

6" high x 14" deep

DRW 12 6 14-3	21.59
DRW 15 6 14-3	23.16
DRW 18 6 14-3	24.81
DRW 21 6 14-3	26.56
DRW 24 6 14-3	28.42
DRW 27 6 14-3	30.39
DRW 30 6 14-3	32.48
DRW 33 6 14-3	34.57
DRW 36 6 14-3	36.66

9" high x 14" deep

DRW 12 9 14-3	24.07
DRW 15 9 14-3	25.98
DRW 18 9 14-3	27.91
DRW 21 9 14-3	29.84
DRW 24 9 14-3	31.77
DRW 27 9 14-3	33.70
DRW 30 9 14-3	35.62
DRW 33 9 14-3	37.58
DRW 36 9 14-3	39.50

**ALPHA
CABINET
COMPONENTS**

12" deep Closet Panels

Panel Heights

Nominal Height	Actual Millimeters	Actual Inches
24"	595mm	23 7/16"
30"	755mm	29 3/4"
36"	915mm	36"
42"	1075mm	42 5/16"
48"	1203mm	47 3/8"
60"	1523mm	59 15/16"
72"	1843mm	72 9/16"
84"	2131mm	83 7/8"
96"	2419mm	95 1/4"

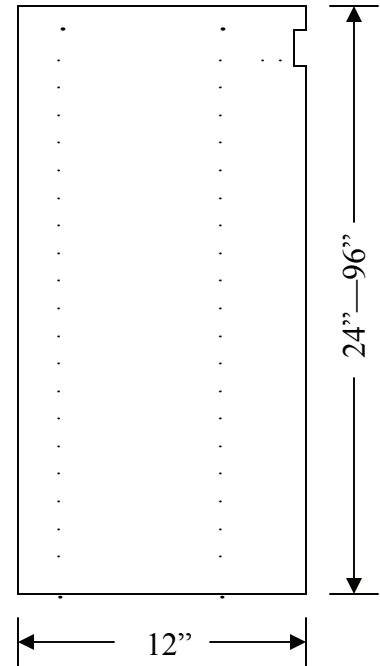

12" Closet End Panels	
CEL 24 12 CER 24 12	9.00
CEL 30 12 CER 30 12	10.50
CEL 36 12 CER 36 12	12.00
CEL 42 12 CER 42 12	13.25
CEL 48 12 CER 48 12	14.56
CEL 60 12 CER 60 12	17.00
CEL 72 12 CER 72 12	19.50
CEL 84 12 CER 84 12	21.88
CEL 96 12 CER 96 12	24.26

12" Closet Center Panels	
CCP 24 12	12.00
CCP 30 12	13.50
CCP 36 12	15.00
CCP 42 12	16.25
CCP 48 12	17.56
CCP 60 12	20.00
CCP 72 12	22.5
CCP 84 12	24.88
CCP 96 12	27.26

12" Closet Fixed & Adjustable Shelves	
CFS 12 12 CAS 12 12	5.88
CFS 15 12 CAS 15 12	6.45
CFS 18 12 CAS 18 12	7.05
CFS 21 12 CAS 21 12	7.67
CFS 24 12 CAS 24 12	8.30
CFS 27 12 CAS 27 12	8.90
CFS 30 12 CAS 30 12	9.53
CFS 33 12 CAS 33 12	10.16
CFS 36 12 CAS 36 12	10.80

**ALPHA
CABINET
COMPONENTS**

Drawer Box & Drawer Fronts

for
12" deep Panels

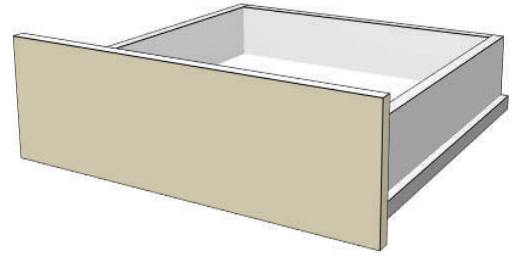

Drawer Front Heights are;

4" DRW = 6 1/8"

6" DRW = 8 11/16"

9" DRW = 11 3/16"

Order Drawer the same width as Fixed

Shelf when ordering non standard widths

Drawer Box and Drawer Front with 1mm Banding

4" high x 12" deep

6" high X 12" deep

9" high x 12" deep

DRW 12 4 12	14.97
DRW 15 4 12	16.17
DRW 18 4 12	17.35
DRW 21 4 12	18.56
DRW 24 4 12	19.75
DRW 27 4 12	20.96
DRW 30 4 12	22.14
DRW 33 4 12	23.32
DRW 36 4 12	24.50

DRW 12 6 12	16.36
DRW 15 6 12	17.85
DRW 18 6 12	19.43
DRW 21 6 12	21.11
DRW 24 6 12	22.89
DRW 27 6 12	24.79
DRW 30 6 12	26.80
DRW 33 6 12	28.81
DRW 36 6 12	30.82

DRW 12 9 12	18.75
DRW 15 9 12	20.57
DRW 18 9 12	22.40
DRW 21 9 12	24.22
DRW 24 9 12	26.05
DRW 27 9 12	27.88
DRW 30 9 12	29.70
DRW 33 9 12	31.52
DRW 36 9 12	33.35

Drawer Box and Drawer Front with 3mm Banding

4" high x 12" deep

6" high x 12" deep

9" high x 12" deep

DRW 12 4 12-3	20.12
DRW 15 4 12-3	21.37
DRW 18 4 12-3	22.60
DRW 21 4 12-3	23.85
DRW 24 4 12-3	25.09
DRW 27 4 12-3	26.35
DRW 30 4 12-3	27.58
DRW 33 4 12-3	28.80
DRW 36 4 12-3	30.05

DRW 12 6 12-3	20.12
DRW 15 6 12-3	21.37
DRW 18 6 12-3	22.60
DRW 21 6 12-3	23.85
DRW 24 6 12-3	25.09
DRW 27 6 12-3	26.35
DRW 30 6 12-3	27.58
DRW 33 6 12-3	28.80
DRW 36 6 12-3	30.05

DRW 12 9 12-3	24.07
DRW 15 9 12-3	25.98
DRW 18 9 12-3	27.91
DRW 21 9 12-3	29.84
DRW 24 9 12-3	31.77
DRW 27 9 12-3	33.70
DRW 30 9 12-3	35.62
DRW 33 9 12-3	37.58
DRW 36 9 12-3	39.50

Actual door heights are listed above each column.
Door heights are in 32mm increments to fit anywhere
on the system.

DOOR with 1MM PVC Edge

18 3/4" high (476mm)

21 1/4" high (540mm)

23 3/4" high (604mm)

D 12 18	9.47	D 12 21	10.21	D 12 24	10.78
D 15 18	10.40	D 15 21	11.13	D 15 24	11.85
D 18 18	11.33	D 18 21	12.13	D 18 24	12.93
D 21 18	14.58	D 21 21	15.59	D 21 24	17.20
2D 21 18	17.52	2D 21 21	18.70	2D 21 24	20.17
2D 24 18	18.94	2D 24 21	20.42	2D 24 24	21.56
2D 27 18	19.38	2D 27 21	21.21	2D 27 24	22.33
2D 30 18	20.80	2D 30 21	22.26	2D 30 24	23.39

DOOR with 3mm PVC Edge

18 3/4" high (476mm)

21 1/4" high (540mm)

23 3/4" high (604mm)

D 12 18-3	15.47	D 12 18-3	16.21	D 12 21-3	16.78
D 15 18-3	16.40	D 15 18-3	17.13	D 15 21-3	17.85
D 18 18-3	17.33	D 18 18-3	18.13	D 18 21-3	18.93
D 21 18-3	20.58	D 21 21-3	21.59	D 21 21-3	23.20
2D 21 18-3	26.52	2D 21 21-3	27.70	2D 21 21-3	29.17
2D 24 18-3	27.94	2D 24 21-3	29.42	2D 24 21-3	30.56
2D 27 18-3	28.38	2D 27 21-3	30.21	2D 27 21-3	31.33
2D 30 18-3	29.80	2D 30 21-3	31.26	2D 30 21-3	32.39

*Actual door heights are listed above each column.
Door heights are in 32mm increments to fit anywhere
on the system.*

DOOR with 1MM PVC Edge

26 1/4" high (668mm)

D 12 27	11.60
D 15 27	12.76
D 18 27	13.92
D 21 27	16.70
2D 21 27	21.70
2D 24 27	23.01
2D 27 27	24.00
2D 30 27	25.17

28 13/16" high (732mm)

D 12 30	12.43
D 15 30	13.68
D 18 30	14.92
D 21 30	18.21
2D 21 30	23.21
2D 24 30	24.45
2D 27 30	25.69
2D 30 30	29.95

DOOR with 3mm PVC Edge

26 1/4" high (668mm)

D 12 27-3	17.60
D 15 27-3	18.76
D 18 27-3	19.92
D 21 27-3	23.70
2D 21 27-3	30.69
2D 24 27-3	31.95
2D 27 27-3	33.01
2D 30 27-3	34.17

28 13/16" high (732mm)

D 12 30-3	18.43
D 15 30-3	19.68
D 18 30-3	20.92
D 21 30-3	24.21
2D 21 30-3	32.21
2D 24 30-3	33.35
2D 27 30-3	34.69
2D 30 30-3	35.95