



[BCIS Home](#) |
 [Log In](#) |
 [User Registration](#) |
 [Hot Topics](#) |
 [Submit Surcharge](#) |
 [Stats & Facts](#) |
 [Publications](#) |
 [FBC Staff](#) |
 [BCIS Site Map](#) |
 [Links](#) |
 [Search](#)



Product Approval
USER: Public User

[Product Approval Menu](#) >
 [Product or Application Search](#) >
 [Application List](#) >
 [Application Detail](#)



FL #	FL11020-R3								
Application Type	Revision								
Code Version	2017								
Application Status	Approved								
Comments	Archived								
Product Manufacturer	Elite Aluminum Corporation								
Address/Phone/Email	4650 Lyons Technology Parkway Coconut Creek, FL 33073 (954) 949-3200 dk@dokimengineering.net								
Authorized Signature	Frank Bennardo frank@engineeringexpress.com								
Technical Representative	Bruce Peacock								
Address/Phone/Email	4650 Lyons Technology Parkway Coconut Creek, FL 33073 (954) 949-3200 bpeacock@elitealuminum.com								
Quality Assurance Representative									
Address/Phone/Email									
Category	Windows								
Subcategory	Horizontal Slider								
Compliance Method	Evaluation Report from a Florida Registered Architect or a Licensed Florida Professional Engineer Evaluation Report - Hardcopy Received								
Florida Engineer or Architect Name who developed the Evaluation Report	Frank L. Bennardo								
Florida License	PE-0046549								
Quality Assurance Entity	QAI Laboratories								
Quality Assurance Contract Expiration Date	04/30/2021								
Validated By	Troy Bishop, P.E. Validation Checklist - Hardcopy Received								
Certificate of Independence	FL11020_R3_COI_Indep1.pdf FL11020_R3_COI_Indep2.pdf								
Referenced Standard and Year (of Standard)	<table border="0"> <thead> <tr> <th><u>Standard</u></th> <th><u>Year</u></th> </tr> </thead> <tbody> <tr> <td>TAS 201</td> <td>1994</td> </tr> <tr> <td>TAS 202</td> <td>1994</td> </tr> <tr> <td>TAS 203</td> <td>1994</td> </tr> </tbody> </table>	<u>Standard</u>	<u>Year</u>	TAS 201	1994	TAS 202	1994	TAS 203	1994
<u>Standard</u>	<u>Year</u>								
TAS 201	1994								
TAS 202	1994								
TAS 203	1994								
Equivalence of Product Standards Certified By									
Sections from the Code									

Product Approval Method Method 1 Option D

Date Submitted 08/15/2017

Date Validated 08/28/2017

Date Pending FBC Approval 08/29/2017

Date Approved 10/10/2017

Summary of Products

FL #	Model, Number or Name	Description
11020.1	Elite 3000 Horizontal Sliding Window, LMI	Elite 3000 Horizontal Sliding Window Large Missile Impact Resistant
Limits of Use Approved for use in HVHZ: Yes Approved for use outside HVHZ: Yes Impact Resistant: Yes Design Pressure: +60/-65 Other: Refer to engineering drawing for limitations of use.		Installation Instructions FL11020_R3_II_Dwg1 .pdf Verified By: Frank L. Bennardo #PE0046549 Created by Independent Third Party: Yes Evaluation Reports FL11020_R3_AE_Eval1.pdf Created by Independent Third Party: Yes
11020.2	Elite 3000 Horizontal Sliding Window, NI	Elite 3000 Horizontal Sliding Window Non-Impact Resistant
Limits of Use Approved for use in HVHZ: Yes Approved for use outside HVHZ: Yes Impact Resistant: No Design Pressure: +55/-55 Other: Refer to engineering drawing for limitations of use.		Installation Instructions FL11020_R3_II_Dwg2 .pdf Verified By: Frank L. Bennardo # PE0046549 Created by Independent Third Party: Yes Evaluation Reports FL11020_R3_AE_Eval2.pdf Created by Independent Third Party: Yes

[Back](#) [Next](#)

Contact Us :: 2601 Blair Stone Road, Tallahassee FL 32399 Phone: 850-487-1824

The State of Florida is an AA/EEO employer. [Copyright 2007-2013 State of Florida](#), :: [Privacy Statement](#) :: [Accessibility Statement](#) :: [Refund Statement](#)

Under Florida law, email addresses are public records. If you do not want your e-mail address released in response to a public-records request, do not send electronic mail to this entity. Instead, contact the office by phone or by traditional mail. If you have any questions, please contact 850.487.1395. *Pursuant to Section 455.275(1), Florida Statutes, effective October 1, 2012, licensees licensed under Chapter 455, F.S. must provide the Department with an email address if they have one. The emails provided may be used for official communication with the licensee. However email addresses are public record. If you do not wish to supply a personal address, please provide the Department with an email address which can be made available to the public. To determine if you are a licensee under Chapter 455, F.S., please click [here](#).



Credit Card
Safe



ELITE 3000 HORIZONTAL SLIDING WINDOW

LARGE MISSILE IMPACT RESISTANT

LARGE MISSILE IMPACT APPROVED
MAXIMUM ALLOWABLE DESIGN PRESSURES

+ 60 PSF
- 65 PSF

DESIGN NOTES:

POSITIVE AND NEGATIVE DESIGN PRESSURES CALCULATED FOR USE WITH THIS SYSTEM SHALL BE DETERMINED BY OTHERS ON A JOB-SPECIFIC BASIS IN ACCORDANCE WITH THE ACCORDANCE WITH ASSESSMENT AND TESTING REQUIREMENTS AS DETERMINED IN THE DESIGN DOCUMENTS. THE POSITIVE AND NEGATIVE DESIGN PRESSURE CAPACITY SHALL BE LESS THAN OR EQUAL TO THE POSITIVE OR NEGATIVE DESIGN PRESSURE CAPACITY VALUES LISTED HEREIN FOR ANY ASSEMBLY AS SHOWN.

GENERAL NOTES:

- THIS SYSTEM DESCRIBED HEREIN HAS BEEN DESIGNED AND TESTED IN ACCORDANCE WITH THE FLORIDA BUILDING CODE SIXTH EDITION (2017) PER TAS 201 / 202 / 203 STANDARDS FOR USE WITHIN AND OUTSIDE THE HIGH VELOCITY HURRICANE ZONE 1B.
- DESIGN PRESSURES NOTED HEREIN ARE BASED ON MAXIMUM TESTED PRESSURES DIVIDED BY A 1.5 SAFETY FACTOR.
- UNITS GLAZED WITH 3/4" LAMINATED GLASS (LAMINATED WITH 1/8" SAFEX HP INTERLAYER) ARE LARGE MISSILE IMPACT RESISTANT AND DO NOT REQUIRE IMPACT RESISTANT SHUTTERS. THIS PRODUCT IS APPROVED FOR OX, XO, AND XX.
- CONSIDERATIONS:
- SEALANT BEHIND SEAL OF FRAME CORNER SHALL BE SEALED WITH STRUCTURAL SILICONE.
- MULTIPLE UNITS MAY BE INSTALLED USING STRUCTURAL MULLIONS OR OTHER STRUCTURAL SUPPORTS PER SEPARATE CERTIFICATION.
- NO 33-1/3% INCREASE IN ALLOWABLE STRESS HAS BEEN USED IN THE DESIGN OF ANCHORS OR FASTENERS.
- ANCHOR AND FASTENER DETAIL SHALL BE 3/4" O.C. AND 1/4" DIA. UNLESS OTHERWISE NOTED.
- THE ARCHITECT/ENGINEER OF RECORD FOR THE PROJECT, SUPERSTRUCTURE WITH WHICH THIS DESIGN IS USED SHALL BE RESPONSIBLE FOR PROVIDING THE CONDITIONS PERMITTED CONTRACTOR, WOOD BUGS (BY OTHERS) SHALL BE ANCHORED PROPERLY TO THE EXISTING STRUCTURE.
- THE CONTRACTOR IS RESPONSIBLE FOR OBTAINING ALL NECESSARY PERMITS AND APPROVALS FOR A SPECIFIC SITE. FOR SITE CONDITIONS WHICH DO NOT PROVIDE INFORMATION WHICH THIS DESIGN IS USED SHALL BE RESPONSIBLE FOR PROVIDING THE CONDITIONS PERMITTED CONTRACTOR, WOOD BUGS (BY OTHERS) SHALL BE ANCHORED PROPERLY TO THE EXISTING STRUCTURE.
- ALL ALUMINUM EXTRUSION SHALL BE EQUIVALENT TO OR GREATER THAN THE MINIMUM INFORMATION TEMPERAS AS SPECIFIED IN THE BILL OF MATERIALS. SEE SHEET 3 FOR MORE INFORMATION.
- GLAZING DETAILS ILLUSTRATED HEREIN UTILIZE 0.100" SAFEX HP INTERLAYER BY EASTMAN CHEMICAL COMPANY (NOA# 14-0423.16).
- ALL ULTRACONS SPECIFIED HEREIN REFER TO ELCO CARBON STEEL ULTRACONS FASTENED TO THICK 3.515 PSI MIN. NON-CRACKED CONCRETE OR ASTM C-90 BLOCK, HOLLOW OR GROUT FILLED PER MANUFACTURER'S RECOMMENDATIONS.
- ALL FASTENERS TO BE 1/4" SAE GRADE 5 CARBON STEEL UNLESS NOTED OTHERWISE. FASTENERS SHALL BE CADMIUM-PLATED OR OTHERWISE ALUMINUM RESISTANT MATERIAL AND SHALL COMPLY WITH SPECIFICATIONS FOR APPLICABLE FEDERAL, STATE, AND LOCAL CODES.
- ALL 3/4" OR 1/2" POP NUTS BE USED PER MANUFACTURER ASSEMBLY PER APPROVED TEST REPORTS.
- THE CONTRACTOR IS RESPONSIBLE TO INSULATE ALL MEMBERS FROM DISSIPILAR MATERIALS TO PREVENT ELECTROLYSIS.
- USE OF THIS SPECIFICATION AND HERE TO VALIDATES STRUCTURAL DESIGN AS SHOWN ONLY. THIS ENGINEER FOR ALL COST & DAMAGES IN CONNECTION WITH THE DESIGN AND CONSTRUCTION PRACTICES BEYOND THAT WHICH IS CALLED FOR BY LOCAL, STATE, & FEDERAL CODES & EXCEPT AS NOTED IN THIS PLAN.
- EXCEPT AS NOTED OTHERWISE, ALL DIMENSIONS ARE IN FEET AND INCHES. APPROXIMATIONS ARE INTENDED.
- ALTERATIONS, ADDITIONS, OR OTHER MARKINGS TO THIS DOCUMENT ARE NOT PERMITTED AND INVALIDATE THIS CERTIFICATION. PRODUCT SHALL BE PERMANENTLY LABELED WITH A MINIMUM OF ONE LABEL PER WINDOW ALLOWING THE FOLLOWING: ELITE ALUMINUM CORPORATION COCONUT CREEK, FLORIDA TAS 201/202/203 / ASTM E1300-04 APPROVED BY FLORIDA BUILDING COMMISSION FLORIDA PRODUCT APPROVAL NUMBER F-14142a (THIS PRODUCT HAS BEEN TESTED PER THE TEST STANDARDS LISTED ABOVE AS REFERENCED IN THESE TEST REPORTS #HETI-04-1405 AND HETI-04-1916 BY HURRICANE ENGINEERING AND TESTING, INC.) SAFEGUARDS MUST BE OBSERVED (NOT IN THIS CERTIFICATION)

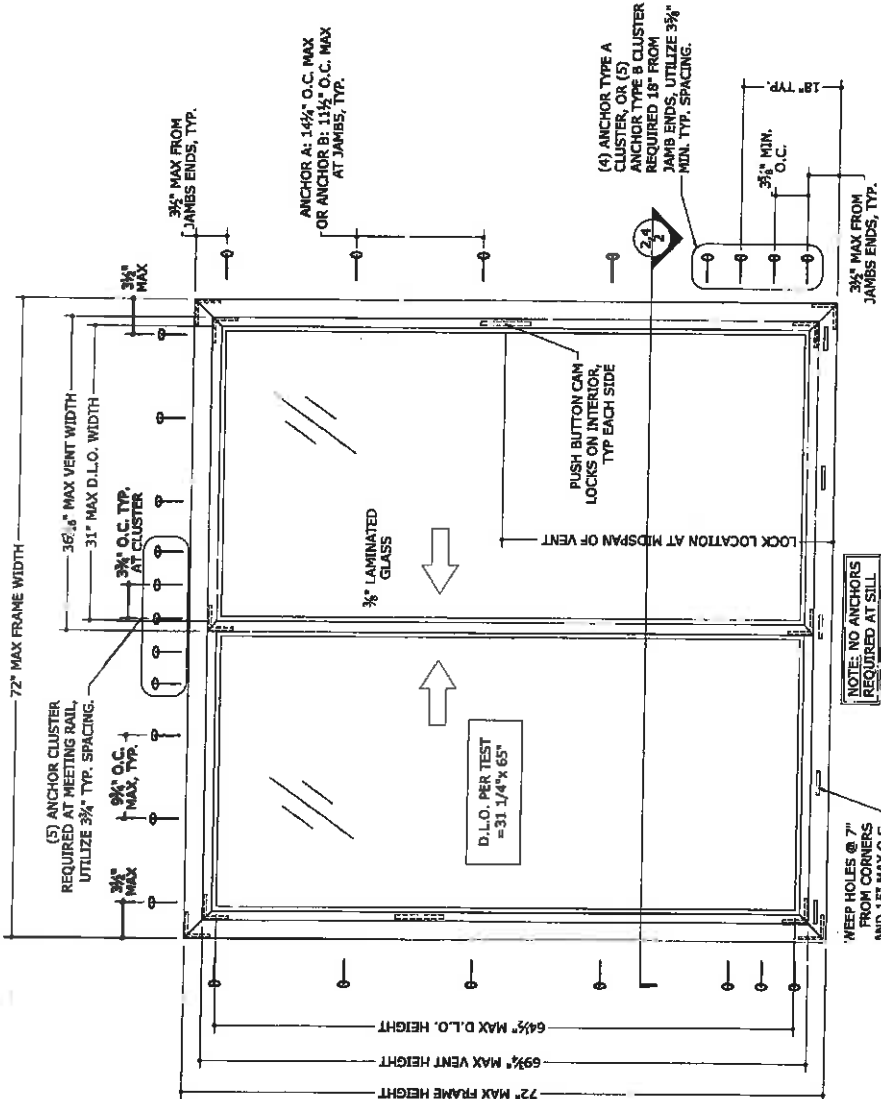

1 TYPICAL EXTERIOR ELEVATION
 INTERIOR ELEV.
 N.T.S.

FRANK L. BERNARDO, P.E.
 # FD080149
 BE 19729/2017
 No. 1185783
 160 SW 12th Avenue, #106
 Deerfield Beach, FL 33442
 Tel: (561) 426-7777
 Fax: (561) 426-7777
 E: HELLO@ENGINEERINGEXPRESS.COM
 WWW.ENGINEERINGEXPRESS.COM
 CERT. OF AUTH. # 1120, 1

ELITE CORPORATION
 Building Innovation
 4650 Lyons Technology Parkway
 Coconut Creek, FL 33073
 ELITE 3000 XX HORIZONTAL SLIDING WINDOW
 LARGE MISSILE IMPACT RESISTANT
 FLORIDA STATEMENT APPROVAL - FL#1120, 1

QUANTITY	1	14-142a
DATE	08/15/2017	
PROJECT	ELITE 3000 XX HORIZONTAL SLIDING WINDOW	
DESCRIPTION	LARGE MISSILE IMPACT RESISTANT	
SCALE	N.T.S.	
DRAWN	14-142a	
CHECKED		
DATE		
BY		
DATE		

1
 3

FRANK L. BENVENUTO, P.E.
 STATE OF FLORIDA
 PROFESSIONAL ENGINEER
 No. PE046549
 EXP. 08/31/2017
 WWW.ENGINEERINGPRESS.COM
 CERT. OF AUTH. #8888
 E. HELLER ENGINEERING PRESS, INC.
 P.O. BOX 1000
 DEERFIELD BEACH, FL 33442
 (561) 351-0000 FAX (561) 351-0000

ELITE ALUMINUM CORPORATION
 Building Innovation
 495 Lyons Technology Parkway
 Coconut Creek, FL 33073
 ELITE 3000 XX HORIZONTAL SLIDING WINDOW
 LARGE MESSLE IMPACT RESISTANT
 FLORIDA STATEWIDE APPROVAL-FL-11020.1

NO.	REV.	DATE	DESCRIPTION
1	0	08/15/17	ISSUED FOR PERMIT
2	1	07/28/17	REVISED PER PERMIT
3	1	12/21/16	REVISED PER PERMIT
4	1	08/15/17	REVISED PER PERMIT

14-14428
 PANEL DIMENSIONS (TYP.)

2

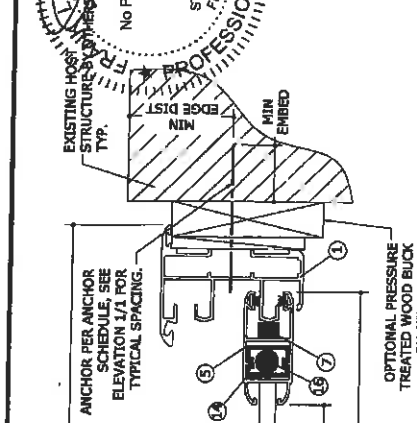

ANCHOR SCHEDULE:

ANCHOR TYPE	ANCHOR DESCRIPTION
"A"	<ul style="list-style-type: none"> 5/16" Ø ELCO ULTRACON (1 1/2" MIN ENBED TO 3" MIN. THICK 3515 PSI MIN. NON-CRACKED CONCRETE, 2 1/2" MIN. EDGE DISTANCE), OR 2x4" MIN ENBED TO GROUT FILLED BLOCK, 4" MIN. EDGE DISTANCE) 3/4" Ø SHS INTO 6063-T6 MIN. ALUMINUM OR A36 MIN. STEEL (1/8" MIN. THICKNESS), PROVIDE (5) PINCHES MIN. PAST THREAD PLANE.
"B"	<ul style="list-style-type: none"> 3/4" Ø LAG SCREW INTO 2x WOOD BUCK OR WOOD STRUCTURE (2x4" MIN. THREAD PENETRATION, 7/8" MIN. EDGE DISTANCE).

ANCHOR NOTES:

- SEE EXTERIOR ELEVATION 1/1 FOR ANCHOR LOCATIONS AND/OR SPACING.
- ANCHORS SHALL BE INSTALLED IN ACCORDANCE WITH MANUFACTURERS' RECOMMENDATIONS.
- PROVIDE 3/4" MIN. EDGE DISTANCE TO ALUMINUM SUBSTRATE AND 1/2" MIN. EDGE DISTANCE TO STEEL.
- ALL CONCRETE ANCHORS SHALL BE INSTALLED TO NON-CRACKED CONCRETE ONLY.
- WOOD HOST STRUCTURE SHALL BE "SOUTHERN PINE-0-55 OR GREATER DENSITY.
- MINIMUM ENBEDMENT SHALL BE AS NOTED IN ANCHOR SCHEDULE. MINIMUM ENBEDMENT AND EDGE DISTANCE EXCLUDES STUCCO, FOAM, BRICK AND OTHER WALL FINISHES.
- WHERE EXISTING STRUCTURE IS WOOD FRAMING, FASTENERS ARE INTO ADEQUATE WOOD FRAMING MEMBERS, NOT INTO PLYWOOD.
- WOOD BUCKS (BY OTHERS) SHALL BE ANCHORED PROPERLY TO TRANSFER LOADS TO THE EXISTING STRUCTURE.

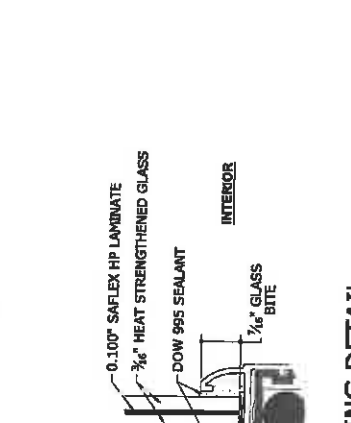

3 GLAZING DETAIL
 2 N.T.S.
 VERT SECT

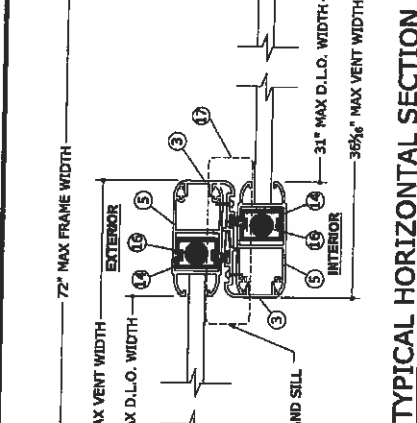

ANCHOR SCHEDULE:

ANCHOR TYPE	ANCHOR DESCRIPTION
"A"	<ul style="list-style-type: none"> 5/16" Ø ELCO ULTRACON (1 1/2" MIN ENBED TO 3" MIN. THICK 3515 PSI MIN. NON-CRACKED CONCRETE, 2 1/2" MIN. EDGE DISTANCE), OR 2x4" MIN ENBED TO GROUT FILLED BLOCK, 4" MIN. EDGE DISTANCE) 3/4" Ø SHS INTO 6063-T6 MIN. ALUMINUM OR A36 MIN. STEEL (1/8" MIN. THICKNESS), PROVIDE (5) PINCHES MIN. PAST THREAD PLANE.
"B"	<ul style="list-style-type: none"> 3/4" Ø LAG SCREW INTO 2x WOOD BUCK OR WOOD STRUCTURE (2x4" MIN. THREAD PENETRATION, 7/8" MIN. EDGE DISTANCE).

ANCHOR NOTES:

- SEE EXTERIOR ELEVATION 1/1 FOR ANCHOR LOCATIONS AND/OR SPACING.
- ANCHORS SHALL BE INSTALLED IN ACCORDANCE WITH MANUFACTURERS' RECOMMENDATIONS.
- PROVIDE 3/4" MIN. EDGE DISTANCE TO ALUMINUM SUBSTRATE AND 1/2" MIN. EDGE DISTANCE TO STEEL.
- ALL CONCRETE ANCHORS SHALL BE INSTALLED TO NON-CRACKED CONCRETE ONLY.
- WOOD HOST STRUCTURE SHALL BE "SOUTHERN PINE-0-55 OR GREATER DENSITY.
- MINIMUM ENBEDMENT SHALL BE AS NOTED IN ANCHOR SCHEDULE. MINIMUM ENBEDMENT AND EDGE DISTANCE EXCLUDES STUCCO, FOAM, BRICK AND OTHER WALL FINISHES.
- WHERE EXISTING STRUCTURE IS WOOD FRAMING, FASTENERS ARE INTO ADEQUATE WOOD FRAMING MEMBERS, NOT INTO PLYWOOD.
- WOOD BUCKS (BY OTHERS) SHALL BE ANCHORED PROPERLY TO TRANSFER LOADS TO THE EXISTING STRUCTURE.

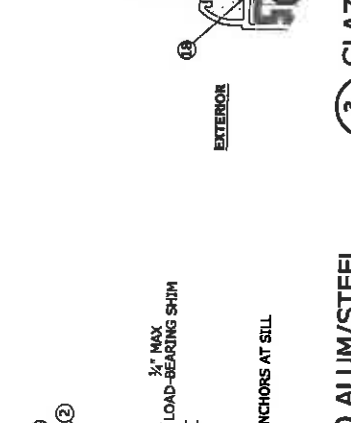

4 ALTERNATE CONN TO ALUM/STEEL
 2 N.T.S.
 VERT SECT

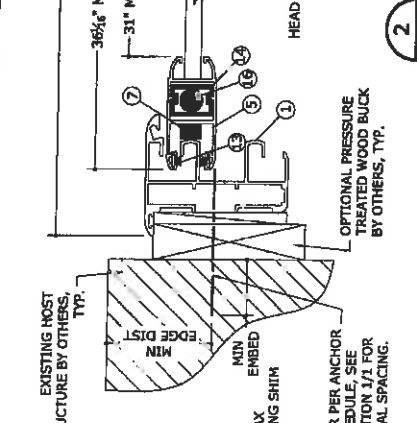

ANCHOR SCHEDULE:

ANCHOR TYPE	ANCHOR DESCRIPTION
"A"	<ul style="list-style-type: none"> 5/16" Ø ELCO ULTRACON (1 1/2" MIN ENBED TO 3" MIN. THICK 3515 PSI MIN. NON-CRACKED CONCRETE, 2 1/2" MIN. EDGE DISTANCE), OR 2x4" MIN ENBED TO GROUT FILLED BLOCK, 4" MIN. EDGE DISTANCE) 3/4" Ø SHS INTO 6063-T6 MIN. ALUMINUM OR A36 MIN. STEEL (1/8" MIN. THICKNESS), PROVIDE (5) PINCHES MIN. PAST THREAD PLANE.
"B"	<ul style="list-style-type: none"> 3/4" Ø LAG SCREW INTO 2x WOOD BUCK OR WOOD STRUCTURE (2x4" MIN. THREAD PENETRATION, 7/8" MIN. EDGE DISTANCE).

ANCHOR NOTES:

- SEE EXTERIOR ELEVATION 1/1 FOR ANCHOR LOCATIONS AND/OR SPACING.
- ANCHORS SHALL BE INSTALLED IN ACCORDANCE WITH MANUFACTURERS' RECOMMENDATIONS.
- PROVIDE 3/4" MIN. EDGE DISTANCE TO ALUMINUM SUBSTRATE AND 1/2" MIN. EDGE DISTANCE TO STEEL.
- ALL CONCRETE ANCHORS SHALL BE INSTALLED TO NON-CRACKED CONCRETE ONLY.
- WOOD HOST STRUCTURE SHALL BE "SOUTHERN PINE-0-55 OR GREATER DENSITY.
- MINIMUM ENBEDMENT SHALL BE AS NOTED IN ANCHOR SCHEDULE. MINIMUM ENBEDMENT AND EDGE DISTANCE EXCLUDES STUCCO, FOAM, BRICK AND OTHER WALL FINISHES.
- WHERE EXISTING STRUCTURE IS WOOD FRAMING, FASTENERS ARE INTO ADEQUATE WOOD FRAMING MEMBERS, NOT INTO PLYWOOD.
- WOOD BUCKS (BY OTHERS) SHALL BE ANCHORED PROPERLY TO TRANSFER LOADS TO THE EXISTING STRUCTURE.

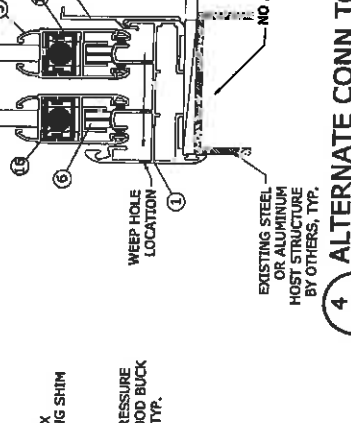

1 TYPICAL VERTICAL SECTION
 2 N.T.S.
 VERT SECT

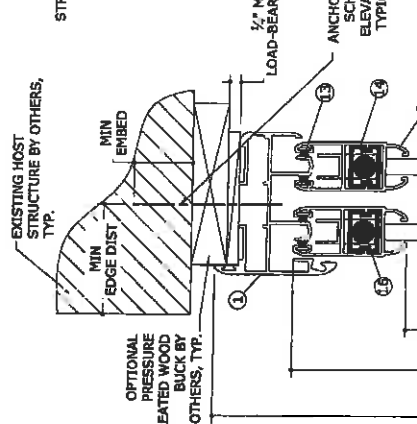

ANCHOR SCHEDULE:

ANCHOR TYPE	ANCHOR DESCRIPTION
"A"	<ul style="list-style-type: none"> 5/16" Ø ELCO ULTRACON (1 1/2" MIN ENBED TO 3" MIN. THICK 3515 PSI MIN. NON-CRACKED CONCRETE, 2 1/2" MIN. EDGE DISTANCE), OR 2x4" MIN ENBED TO GROUT FILLED BLOCK, 4" MIN. EDGE DISTANCE) 3/4" Ø SHS INTO 6063-T6 MIN. ALUMINUM OR A36 MIN. STEEL (1/8" MIN. THICKNESS), PROVIDE (5) PINCHES MIN. PAST THREAD PLANE.
"B"	<ul style="list-style-type: none"> 3/4" Ø LAG SCREW INTO 2x WOOD BUCK OR WOOD STRUCTURE (2x4" MIN. THREAD PENETRATION, 7/8" MIN. EDGE DISTANCE).

ANCHOR NOTES:

- SEE EXTERIOR ELEVATION 1/1 FOR ANCHOR LOCATIONS AND/OR SPACING.
- ANCHORS SHALL BE INSTALLED IN ACCORDANCE WITH MANUFACTURERS' RECOMMENDATIONS.
- PROVIDE 3/4" MIN. EDGE DISTANCE TO ALUMINUM SUBSTRATE AND 1/2" MIN. EDGE DISTANCE TO STEEL.
- ALL CONCRETE ANCHORS SHALL BE INSTALLED TO NON-CRACKED CONCRETE ONLY.
- WOOD HOST STRUCTURE SHALL BE "SOUTHERN PINE-0-55 OR GREATER DENSITY.
- MINIMUM ENBEDMENT SHALL BE AS NOTED IN ANCHOR SCHEDULE. MINIMUM ENBEDMENT AND EDGE DISTANCE EXCLUDES STUCCO, FOAM, BRICK AND OTHER WALL FINISHES.
- WHERE EXISTING STRUCTURE IS WOOD FRAMING, FASTENERS ARE INTO ADEQUATE WOOD FRAMING MEMBERS, NOT INTO PLYWOOD.
- WOOD BUCKS (BY OTHERS) SHALL BE ANCHORED PROPERLY TO TRANSFER LOADS TO THE EXISTING STRUCTURE.

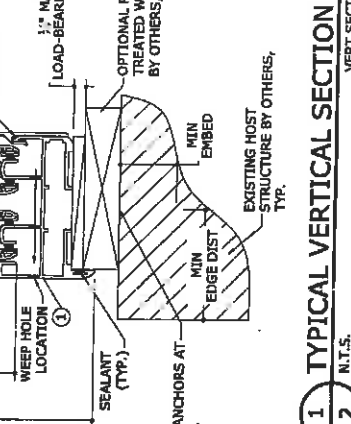

2 TYPICAL VERTICAL SECTION
 2 N.T.S.
 VERT SECT

FRANK L. BEITZ
 No. PE 0004640
 STATE OF FLORIDA
 PROFESSIONAL ENGINEER

ELITE ENGINEERING
 160 SW 12TH AVENUE, SUITE 106
 DEERFIELD BEACH, FL 33442
 Tel: (561) 351-0560 Fax: (561) 351-0543
 E: HELLO@ENGINEERINGEXPRESS.COM
 WWW.ENGINEERINGEXPRESS.COM

ELITE ALUMINUM
 Building Innovation
ELITE
 Panel Products
 4650 Lyons Technology Parkway
 Coconut Creek, FL 33073
 ELITE 3000 XX HORIZONTAL SLIDING WINDOW
 LARGE MISSILE IMPACT RESISTANT
 FLORIDA STATEWIDE APPROVAL-FL#11020.1

REV	DATE	DESCRIPTION
01	06/22/04	INITIALS
02	08/17/04	REVISED FOR PERMITS
03	08/17/04	REVISED FOR PERMITS
04	08/17/04	REVISED FOR PERMITS
05	08/17/04	REVISED FOR PERMITS
06	08/17/04	REVISED FOR PERMITS
07	08/17/04	REVISED FOR PERMITS
08	08/17/04	REVISED FOR PERMITS
09	08/17/04	REVISED FOR PERMITS
10	08/17/04	REVISED FOR PERMITS
11	08/17/04	REVISED FOR PERMITS
12	08/17/04	REVISED FOR PERMITS
13	08/17/04	REVISED FOR PERMITS
14	08/17/04	REVISED FOR PERMITS
15	08/17/04	REVISED FOR PERMITS
16	08/17/04	REVISED FOR PERMITS
17	08/17/04	REVISED FOR PERMITS
18	08/17/04	REVISED FOR PERMITS

Bill of Materials

PART #	DESCRIPTION	MATERIAL	REMARKS
1	26210 FRAME STILE & RAIL	6063-T6	
2	26203 SILL RISER	6063-T6	
3	26225 INTERLOCK ADAPTER*	6063-T6	
4	26218 CAST CORNER LOCK	6063-T6	
5	26211 VENT STILES & RAILS	6063-T6	BY ALSHIN
6	26080 TANDEM ROLLER ASSEMBLY 5245	POLYPROPYLENE	BY ALSHIN
7	26219 SECURITY BLOCK	POLYPROPYLENE	BY PALMAT
8	26223 LATCH HOOK	STAINLESS STEEL	BY YADD
9	26223 KEYSER	NYLON	BY YADD
10	26223 KEYSER	6063-T6	BY YADD
11	26222 WEBS COVER	PLASTIC	BY ALSHIN
12	26221 PLASTIC CAP	PLASTIC	BY PALMAT
13	26207 WOOD PILE WITH FIB W21275NFK	ULTRAFAB	BY PALMAT
14	26207 WOOD PILE WITH FIB W21275NFK	ULTRAFAB	BY PALMAT
15	26223 LATCH HOOK	6063-T6	BY THE LOCKEREN CO.
16	26223 ALUM ROD INSERT	6063-T6	BY YADD
17	26220 1.94"X0.59"X0.41 HIGH PER END	6061-T6	ULTRAFAB
18	1/2" SETTING BLOCK 2" LONG 80 DIAMETER MIN.	(2) PER GLASS AT 1/4 POINTS	ULTRAFAB

BILL OF MATERIALS NOTE:
 * ADHERED TO FRAME WITH SILICONE AND ATTACHED WITH #10x1-1/4" SMS, 1-7/16" FROM EACH END AND 18" O.C. FOR THE BALANCE.
 ** ATTACHED WITH #10x2" SMS, (1) AT EACH END AND 18" O.C. FOR THE BALANCE.

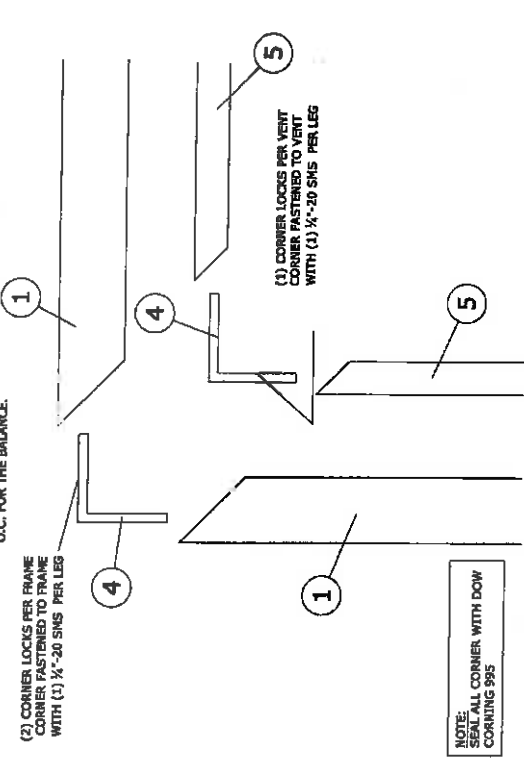

NOTE:
 SEAL ALL CORNER WITH DOW CORNING 995

1 CORNER ASSEMBLY DETAIL
 N.T.S.
 3 ELEV VIEW

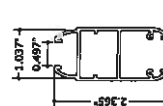

5 VENT STILES & RAILS
 N.T.S.
 6063-T6 ALUM

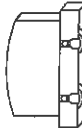

6 TANDEM ROLLER ASSEMBLY
 N.T.S.
 POLYPROPYLENE



14 VENT FRAME INSERT
 N.T.S.
 6063-T6 ALUM



16 ALUM ROD INSERT
 N.T.S.
 6061-T6 ALUM

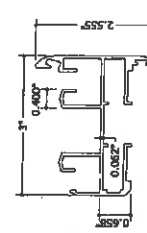

1 FRAME STILE & RAIL
 N.T.S.
 6063-T6 ALUM

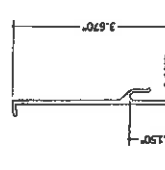

2 SILL RISER
 N.T.S.
 6063-T6 ALUM

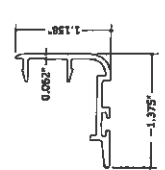

3 INTERLOCK ADAPTOR
 N.T.S.
 6063-T6 ALUM

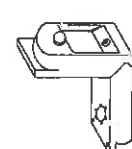

4 CAST CORNER LOCK
 N.T.S.
 DIE CAST ALUM



P.E.R.T.

**ENGINEERING EXPRESS®
PRODUCT EVALUATION REPORT**

**ENGINEERING EXPRESS® EXPERT
PRODUCT EVALUATION REPORT**

August 11, 2017

Application Number: FL# 11020.1-R3
FLB Project Number: 14-1442a

Product Manufacturer: Elite Aluminum Corp.
Manufacturer Address: 4650 Lyons Technology Parkway
Coconut Creek, FL 33073

Product Name & Description: Elite 3000 Horizontal Sliding Window, LMI
Elite 3000 Horizontal Sliding Window Large Missile Impact Resistant

Scope of Evaluation:

This Product Evaluation Report is being issued in accordance with the requirements of the Florida Department of Business and Professional Regulation (Florida Building Commission) Rule Chapter 61G20-3.005, F.A.C., for statewide acceptance per Method 1(d). The product noted above has been tested and/or evaluated as summarized herein to show compliance with the Florida Building Code Sixth Edition (2017) and is, for the purpose intended, at least equivalent to that required by the Code. Re-evaluation of this product shall be required following pertinent Florida Building Code modifications or revisions.

Substantiating Data:

• **PRODUCT EVALUATION DOCUMENTS**

FLB drawing #14-1442a titled "Elite 3000 Horizontal Sliding Window, Large Missile Impact Resistant", sheets 1-3, prepared by Engineering Express, signed & sealed by Frank L. Bennardo, P.E. is an integral part of this Evaluation Report.

• **TEST REPORTS**

Uniform static structural performance has been tested in accordance with TAS 202 test standards per test report(s) #HETI-04-1405 by Hurricane Engineering & Testing, Inc (HETI). Signed and sealed by Ivonne Ghia, P.E.

Large missile impact resistance and cyclic loading performance have been tested in accordance with TAS 201 & 203 test standards per test report(s) #HETI-04-1916 by Hurricane Engineering & Testing, Inc (HETI). Signed and sealed by Ivonne Ghia, P.E.

• **STRUCTURAL ENGINEERING CALCULATIONS**

Structural engineering calculations have been prepared which evaluate the product based on comparative and/or rational analysis to qualify the following design criteria:

1. Anchor Spacing
2. Maximum Allowable Size/Pressure Combinations
3. Glass Capacity
4. Anchor Capacity

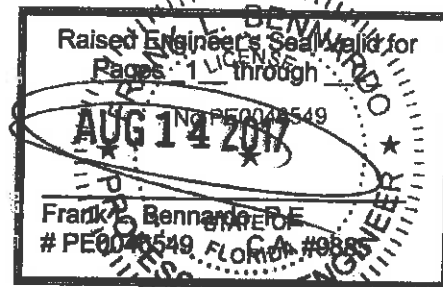

160 SW 12TH AVENUE SUITE 106, DEERFIELD BEACH, FLORIDA 33442
PHONE: (954) 354-0660 - FAX: (954) 354-0443
ENGINEERINGEXPRESS.COM

E.X.P.E.R.T. PRODUCT EVALUATION REPORT (CONTINUED)

No 33% increase in allowable stress has been used in the design of this product.

Impact Resistance:

Large Missile Impact Resistance has been demonstrated as evidenced in previously listed test reports, and is accounted for in the engineering design of this product.

Wind Load Resistance

This product has been designed to resist wind loads as indicated in the span schedule(s) on the Product Evaluation Document (i.e. engineering drawing).

Installation

The product listed above shall be installed in strict compliance with the Product Evaluation Document (i.e. engineering drawing), along with all components noted therein.

The product components shall be of the material specified in the Product Evaluation Document (i.e. engineering drawing).

Limitations & Conditions of Use:

Use of this product shall be in strict accordance with the Product Evaluation Document (i.e. engineering drawing) as noted herein.

All supporting host structures shall be designed to resist all superimposed loads and shall be of a material listed in this product's respective anchor schedule. Host structure conditions which are not accounted for in this product's respective anchor schedule shall be designed for on a site-specific basis by a registered professional engineer.

All components which are permanently installed shall be protected against corrosion, contamination, and other such damage at all times.

This product has been designed for use within and outside the High Velocity Hurricane Zone (HVHZ).



August 11, 2017

Florida Department of Business and Professional Regulation
1940 North Monroe Street, Tallahassee FL 32399

Regarding: Elite Aluminum Corp.
Elite 3000 Horizontal Sliding Window, NI
Project #14-1442b

To Whom It May Concern:

Please be advised that the below-signed engineer does not have nor will acquire a financial interest in the company manufacturing or distributing the product(s) for which an evaluation report or validation certification has been prepared, as referenced above. This engineer is not owned, operated, nor controlled by the manufacturer or distributor noted above and does not have any financial interest in any other entity involved in the approval process of the above-noted product(s).

Respectfully,

~~AUG 14 2017~~

Frank L. Bennardo, P.E.
Frank L. Bennardo, P.E., Inc.
FL PE 0046549
Cert of Auth #9885

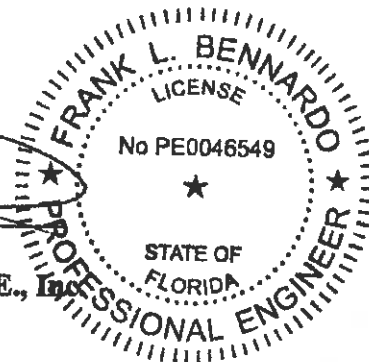



August 11, 2017

Florida Department of Business and Professional Regulation
1940 North Monroe Street, Tallahassee FL 32399

Regarding: Elite Aluminum Corp.
Elite 3000 Horizontal Sliding Window, LMI
Project #14-1442a

To Whom It May Concern:

Please be advised that the below-signed engineer does not have nor will acquire a financial interest in the company manufacturing or distributing the product(s) for which an evaluation report or validation certification has been prepared, as referenced above. This engineer is not owned, operated, nor controlled by the manufacturer or distributor noted above and does not have any financial interest in any other entity involved in the approval process of the above-noted product(s).

Respectfully,

AUG 14 2017

Frank L. Bennardo, P.E.
Frank L. Bennardo, P.E., Inc.
FL PE 0046549
Cert of Auth #9885

