

Cargo Box BRA220R Installation Instructions



These instructions are for the installation and use of the Inno carrier system attachment. After reading this manual, keep it in a safe place along with the installation instructions for the rest of your carrier system.

PRECAUTIONS

Do not overload your cargo box. Maximum load capacity varies by vehicle. Check the appropriate limits for your car in the Fit Guide and your vehicle owner's manual and determine your maximum loading capacity with the formula below.

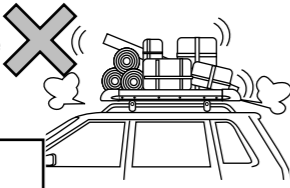

Use the lower of the 2 options below

Max load of cargo box 110 lbs	OR	Max load of vehicle or cross bar	-	Weight of cargo box
----------------------------------	----	----------------------------------	---	---------------------

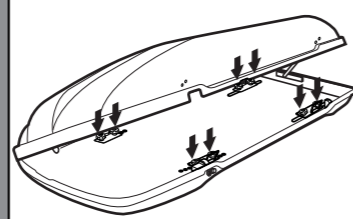

Before driving the vehicle, shake the rack in all directions to ensure that there is no looseness in any of the mounting knobs and screws. Retighten any loose knobs or screws.

The Cargo box includes the parts listed below. Verify that they are included with the carrier you have purchased. In the event any of these is missing, contact our service center as listed at the end of this manual.

NO.	Parts	Qty
①	Rooftop Box	1
②	Knob	8
③	U-Bolt	4
④	Plate	4
⑤	Strap	2
⑥	Strap Hook	2
⑦	Hole Covering	6
⑧	Molding	2
⑨	Key	2
⑩	Manual Instruction	1

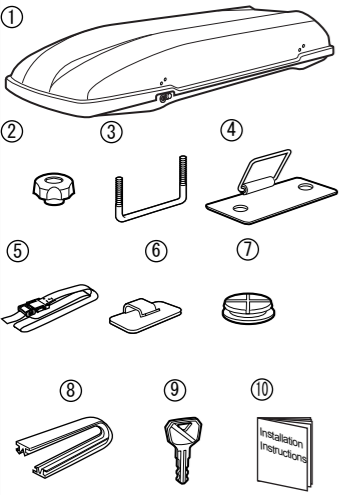

1 If using an aftermarket base rack system, make sure that it is installed properly according to the procedures described in the installation instructions for that rack.

CAUTION

The distance between the front and rear crossbars should be at least 60cm (2 feet)

2 Temporarily put the Box on cross bars. And ①Insert key, turn clockwise and ② push button to open the Box.

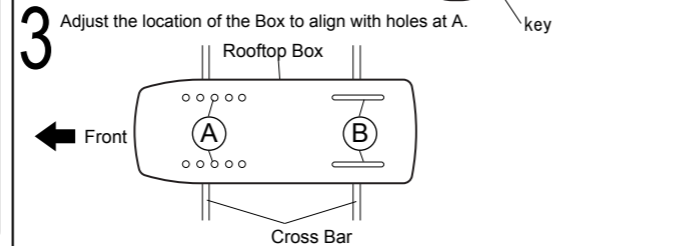
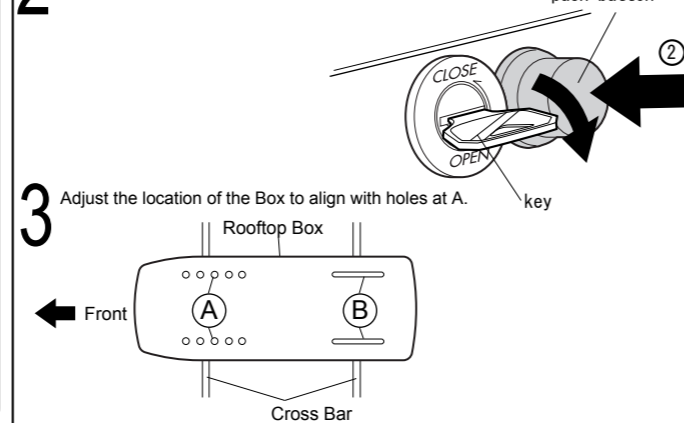

4 Attach the Box to front cross bar with Plate, U-Bolt and Knobs. Make sure that the ring on the Plate is on the side nearest the side of box.

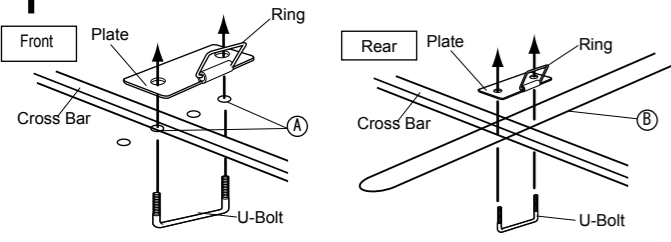

5 Tighten right and left knobs alternately to secure the Box to cross bar.

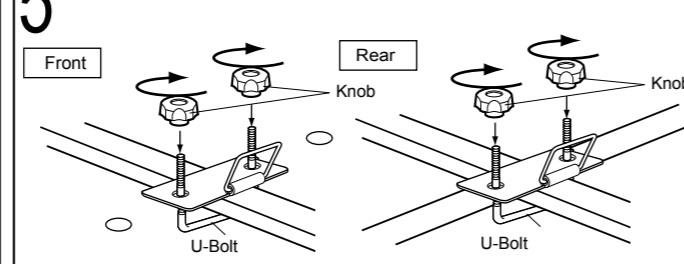

Warning

Make sure to tighten the right and left knobs evenly so that the U-bolt sits square with the bar. If U-bolt is not tightened correctly, it may allow the box to come loose.

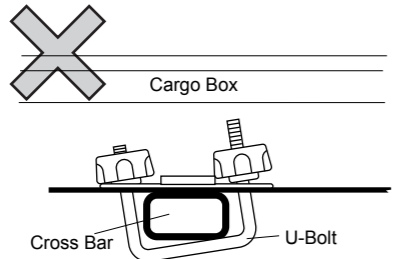

6 Front - Place plugs into the 6 unused holes to seal
Rear - Trim Molding to the proper size and insert into slot.

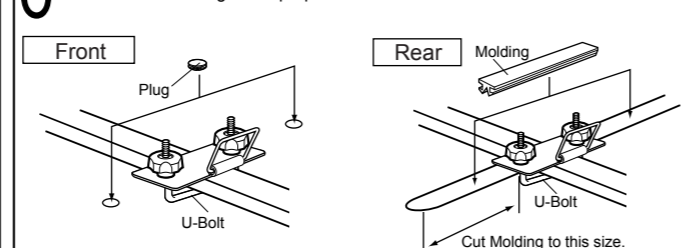

7 Thread Strap through two Rings on each side of the box and fasten. Attach Strap Hooks inside box lid just above Straps.

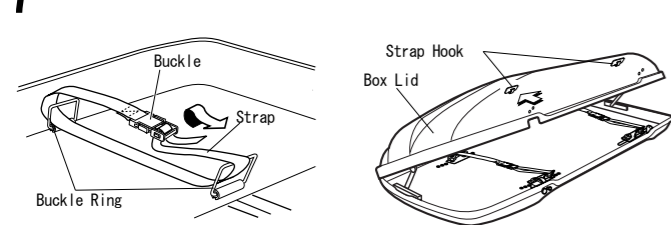

8 Push Box in all directions to make sure that there is no looseness. If you notice any play in the box, retighten 8 Knobs.

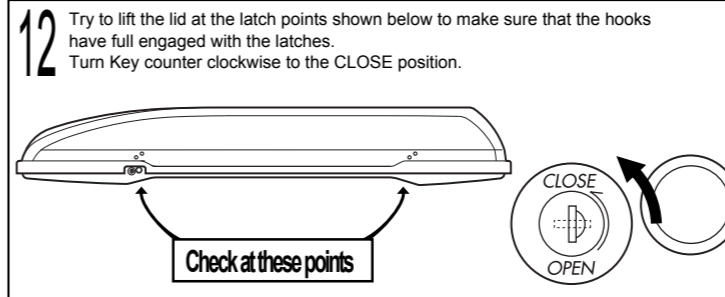
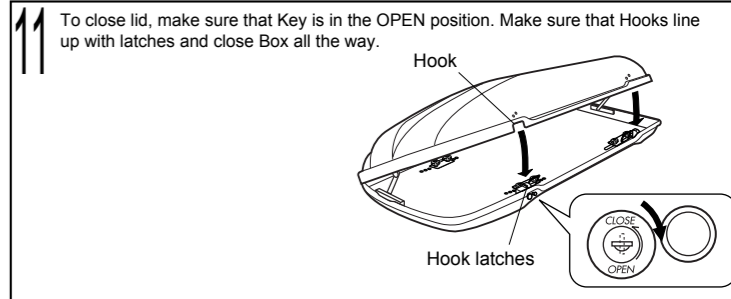
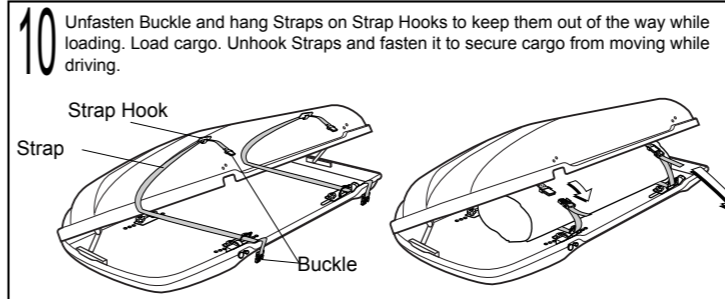
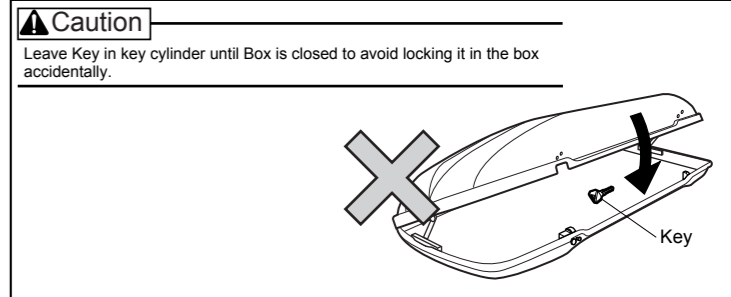
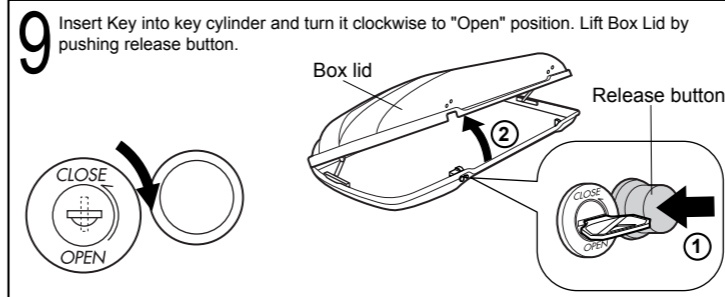

Genuine Inno Replacement Parts

The following genuine replacement parts are available for this Inno carrier system component. Specify the part number when ordering parts from your dealer.

Note
Specifications and the appearance of the carrier system and genuine replacement parts are subject to change without prior notice in the interest of product improvement.

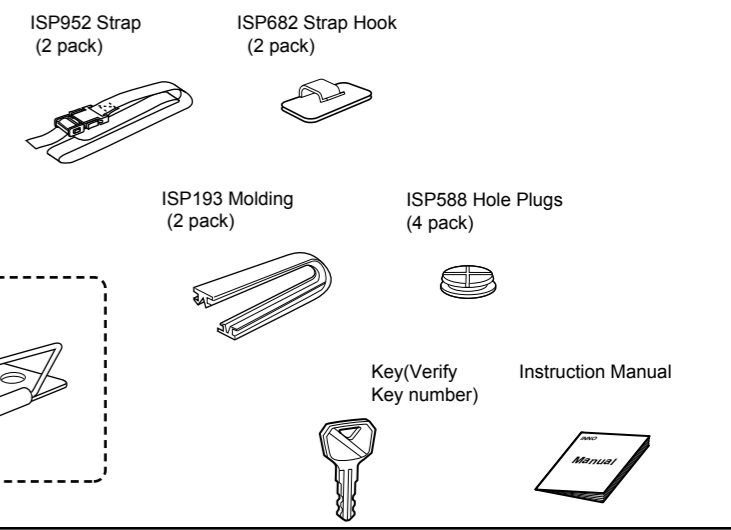
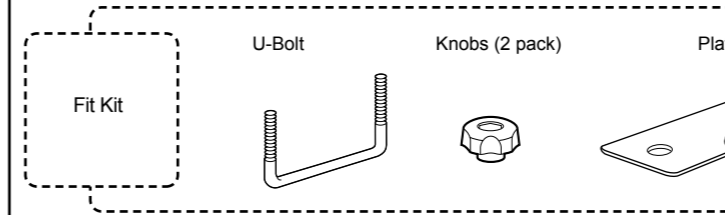

Contact Information

If you have any questions or comments, please contact us at the service center listed below. CarMate shall not be held liable for any accidents or incidental losses arising from improper installation or use, nor for those arising from installation or use after the customer has made any change to the system's original configuration or specifications.

Inno
ADVANCED CAR RACKS
Car Mate USA
383 Van Ness Ave., Suite 1603
Torrance, CA
www.innoracks.com
support@rv-inno.com

Important Notes on the Cargo Box

Read and understand this user's manual thoroughly before using your new cargo box and be sure to follow all usage instructions. Keep this manual in a safe place so that it's handy for reference anytime.

If you have any questions regarding the information in this manual, please contact the service center listed at the end of this manual.

⚠ Precautions

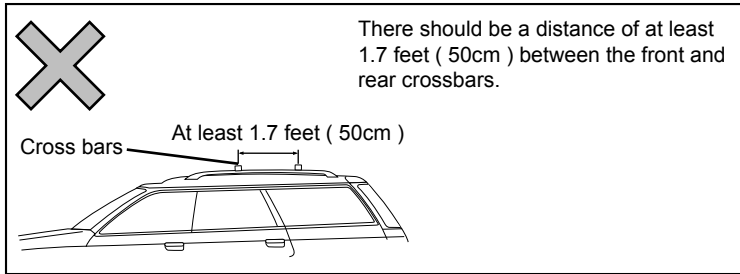
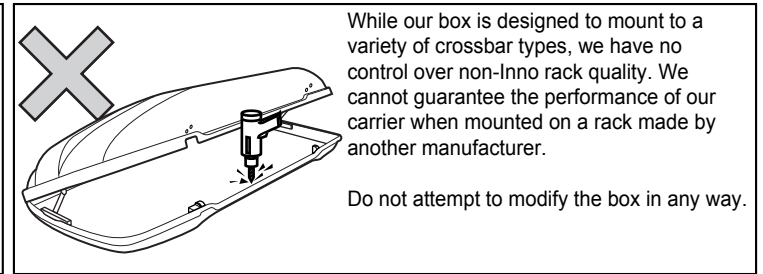
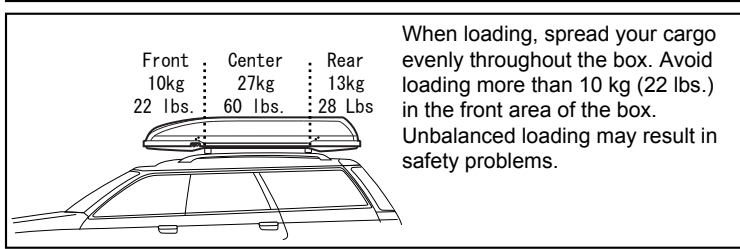
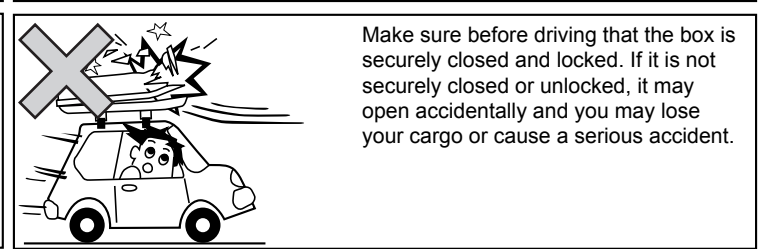
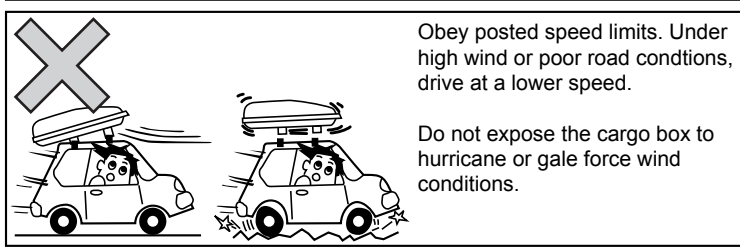
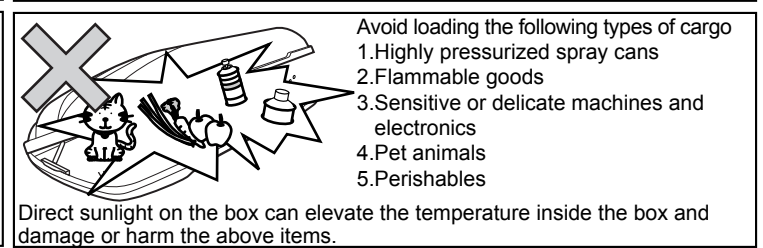
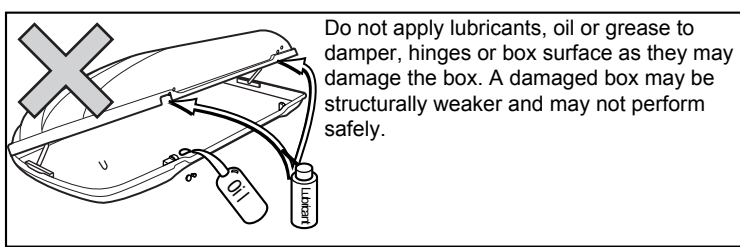
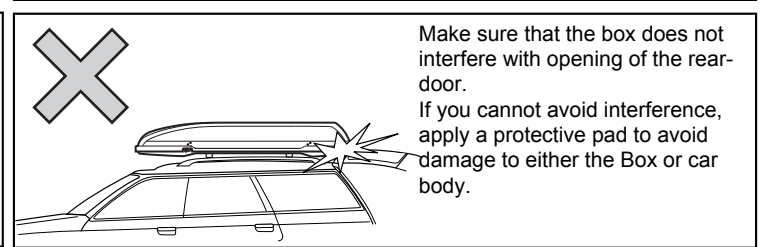
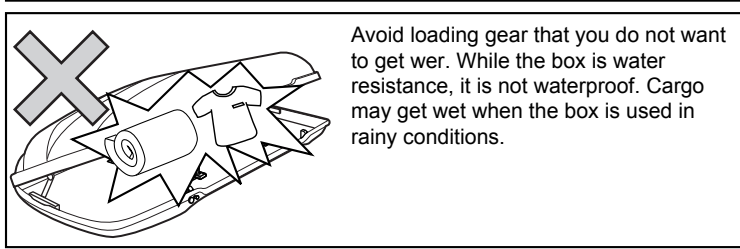
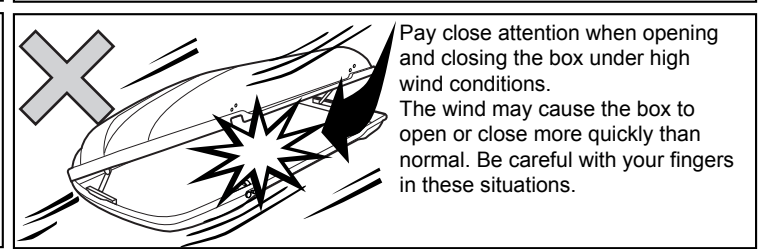
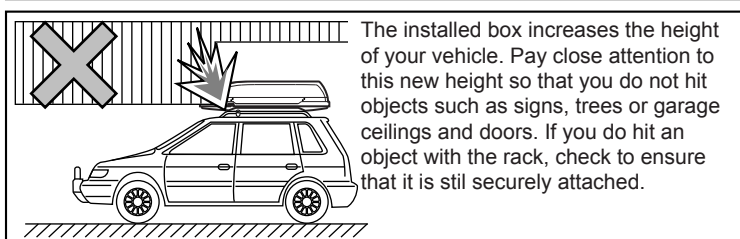
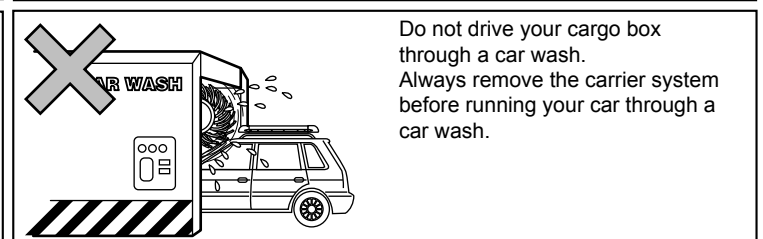
 <p>There should be a distance of at least 1.7 feet (50cm) between the front and rear crossbars.</p>	 <p>While our box is designed to mount to a variety of crossbar types, we have no control over non-Inno rack quality. We cannot guarantee the performance of our carrier when mounted on a rack made by another manufacturer.</p> <p>Do not attempt to modify the box in any way.</p>
 <p>When loading, spread your cargo evenly throughout the box. Avoid loading more than 10 kg (22 lbs.) in the front area of the box. Unbalanced loading may result in safety problems.</p>	 <p>Make sure before driving that the box is securely closed and locked. If it is not securely closed or unlocked, it may open accidentally and you may lose your cargo or cause a serious accident.</p>
 <p>Obey posted speed limits. Under high wind or poor road conditions, drive at a lower speed.</p> <p>Do not expose the cargo box to hurricane or gale force wind conditions.</p>	 <p>Avoid loading the following types of cargo</p> <ol style="list-style-type: none"> 1. Highly pressurized spray cans 2. Flammable goods 3. Sensitive or delicate machines and electronics 4. Pet animals 5. Perishables <p>Direct sunlight on the box can elevate the temperature inside the box and damage or harm the above items.</p>
 <p>Do not apply lubricants, oil or grease to damper, hinges or box surface as they may damage the box. A damaged box may be structurally weaker and may not perform safely.</p>	 <p>Make sure that the box does not interfere with opening of the rear-door.</p> <p>If you cannot avoid interference, apply a protective pad to avoid damage to either the Box or car body.</p>
 <p>Avoid loading gear that you do not want to get wet. While the box is water resistance, it is not waterproof. Cargo may get wet when the box is used in rainy conditions.</p>	 <p>Pay close attention when opening and closing the box under high wind conditions. The wind may cause the box to open or close more quickly than normal. Be careful with your fingers in these situations.</p>
 <p>The installed box increases the height of your vehicle. Pay close attention to this new height so that you do not hit objects such as signs, trees or garage ceilings and doors. If you do hit an object with the rack, check to ensure that it is still securely attached.</p>	 <p>Do not drive your cargo box through a car wash. Always remove the carrier system before running your car through a car wash.</p>

Care and Storage

- 1 Wash any mud off the carrier system. Use a damp towel to wipe away dust and dirt. Do not use any thinner or solvents to clean any part of the carrier system.
- 2 After cleaning carrier, check for any of the following:
 - 1) Worn screw threads
 - 2) Key deformation
 - 3) Holder deformation
 - 4) Cracks in any of the components of the carrier system.
- 3 Store all components of the carrier system together in one place to prevent any component from being lost. Avoid storage in areas subject to direct sunlight, high temperature or excessive humidity.