

Fly

Fly

Fly

10 yd

5 yd

LOS

L

C

R

QB

H

RUN

SPLIT TEE

RUN RIGHT

FLIES

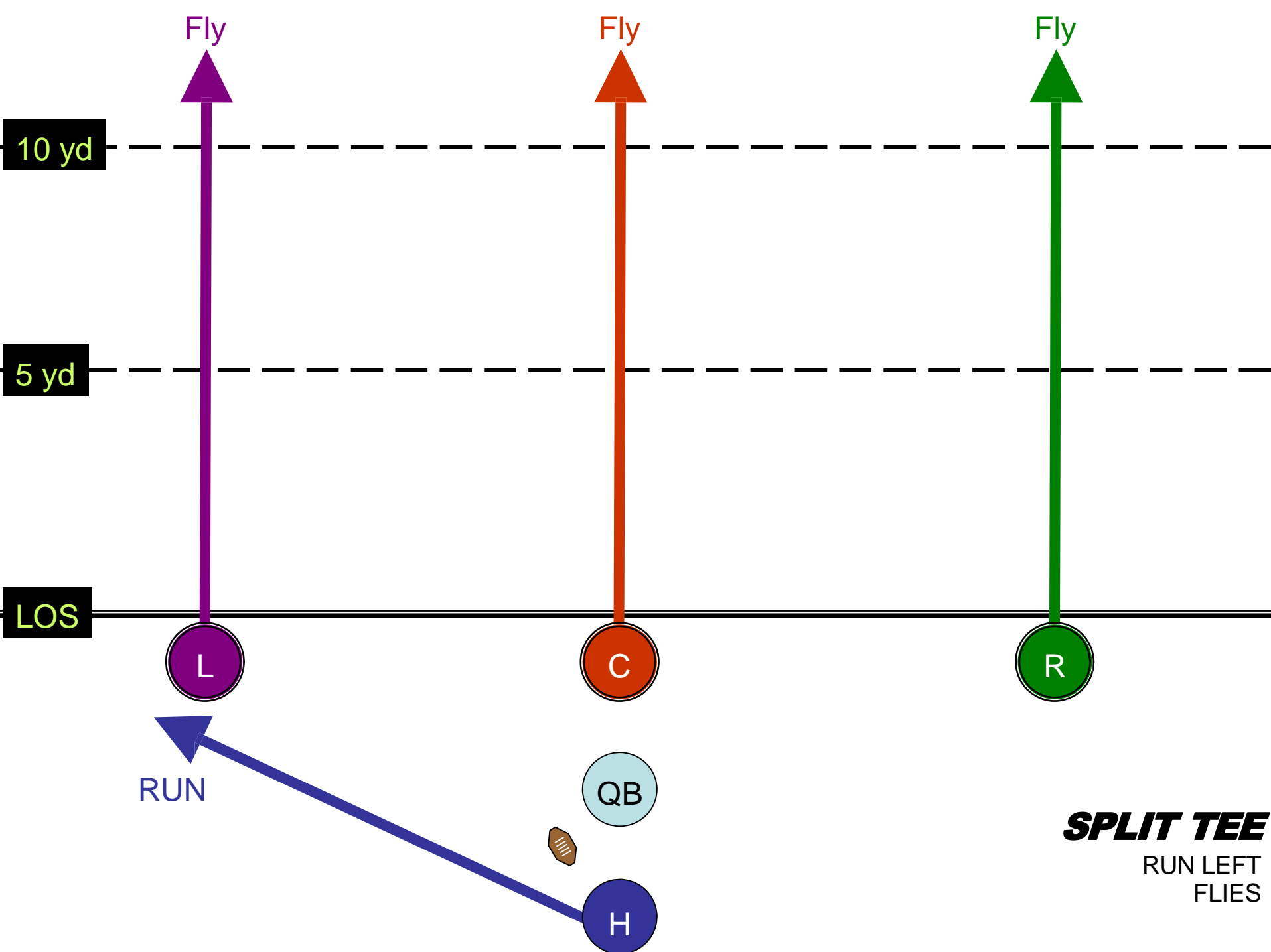

Fly

Fly

Fly

10 yd

5 yd

LOS

L

C

R

RUN

QB

H

SPLIT TEE

RUN LEFT

FLIES

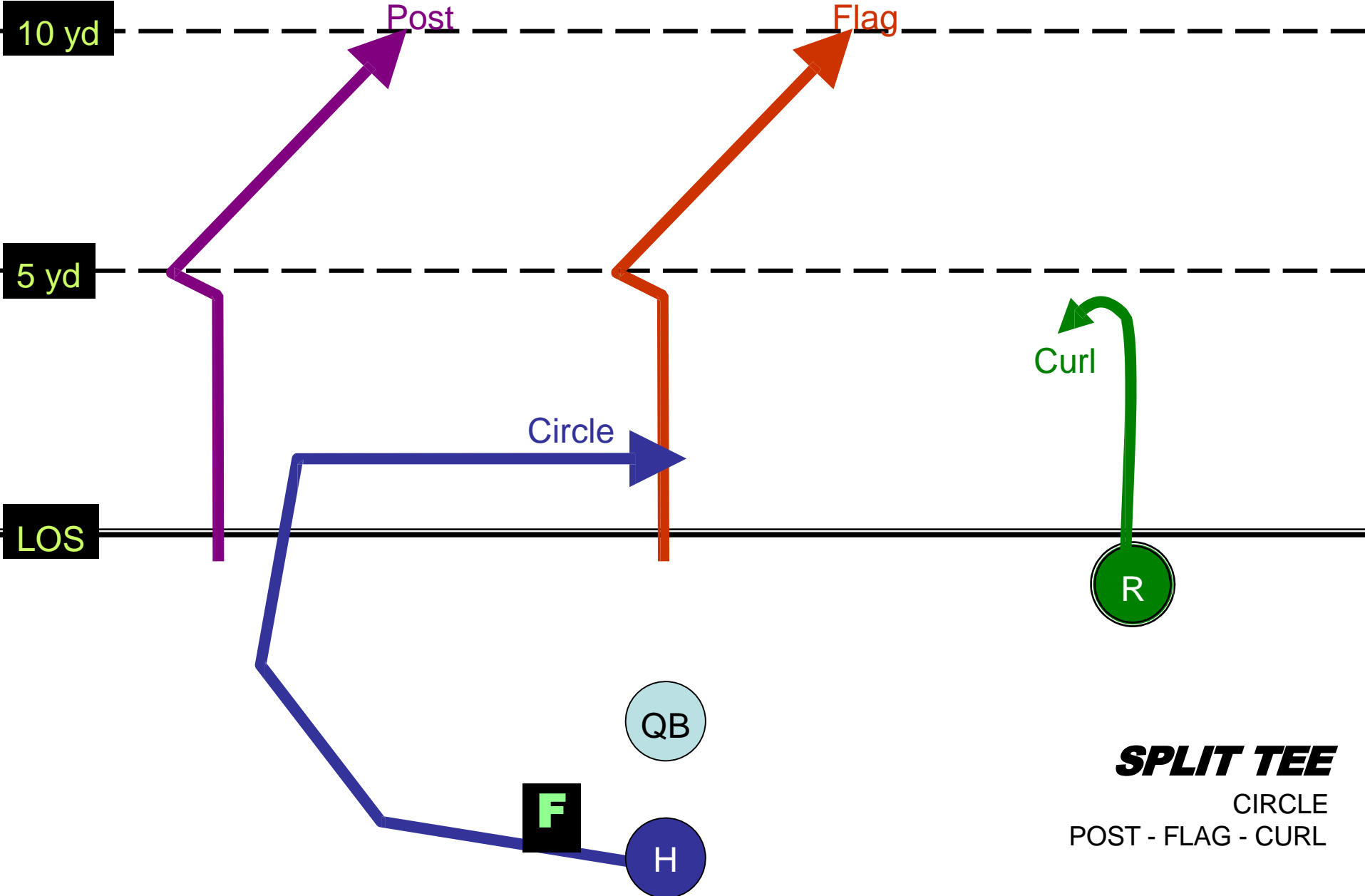

SPLIT TEE

CIRCLE
POST - FLAG - CURL

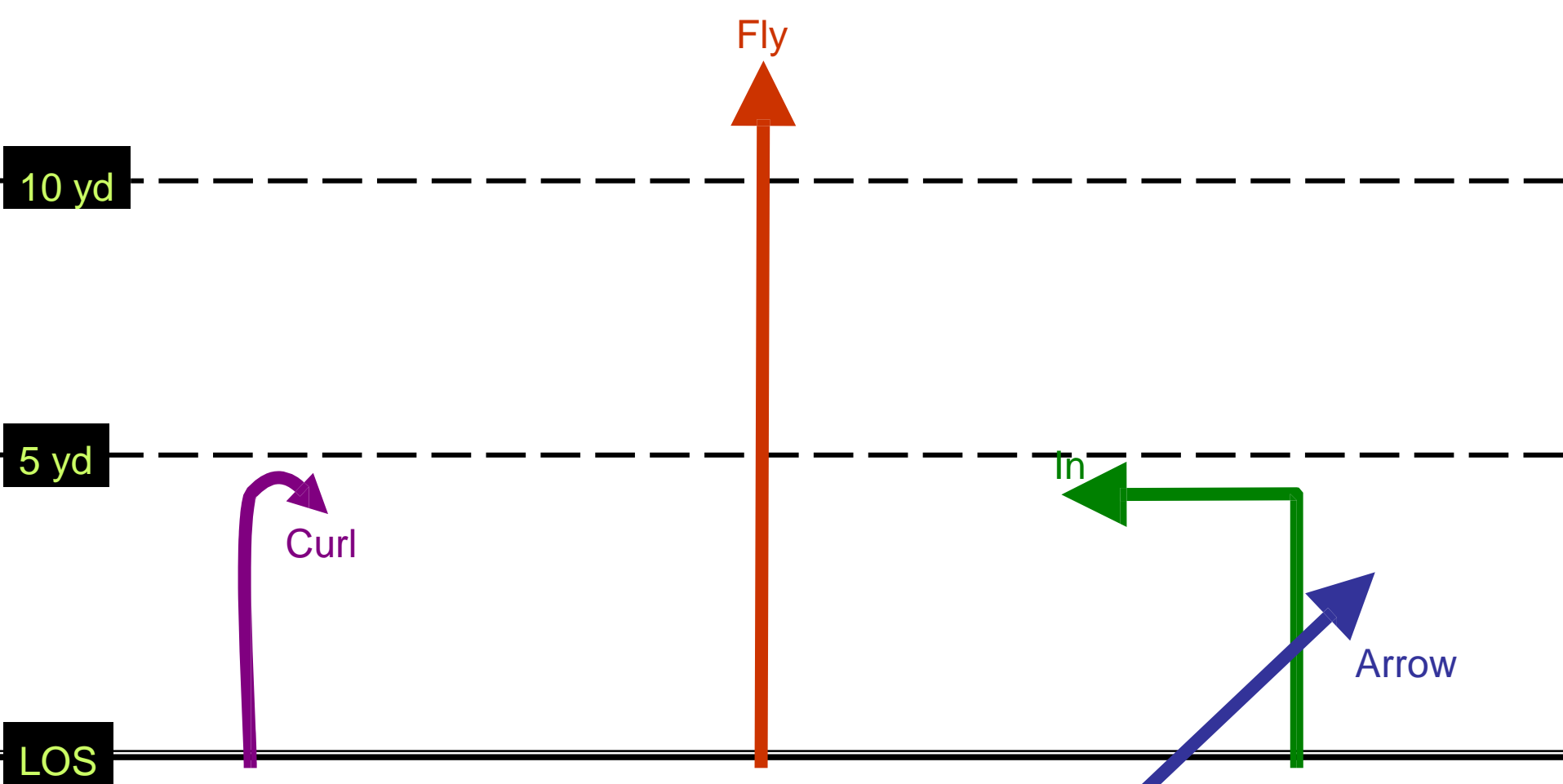

SPLIT TEE
ARROW
CURL – FLY - OUT

QB

F

H

SHORT YARDAGE TWO POINT PAT

10 yd

5 yd

LOS

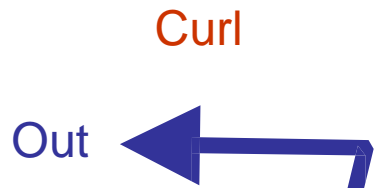

Slant
In



SPLIT TEE

OUT
IN - CURL - SLANT IN

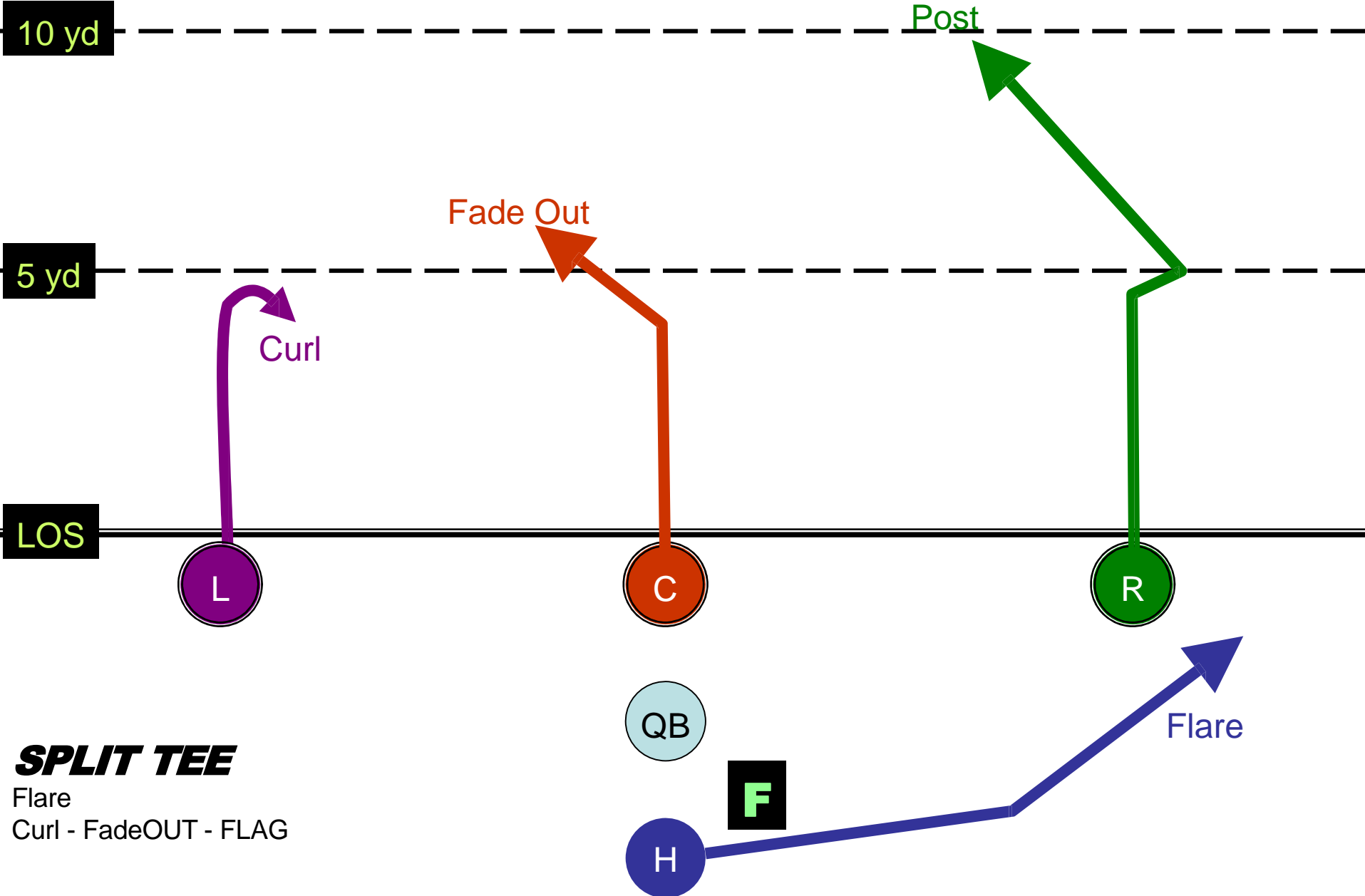

10 yd

Post

5 yd

Fade Out

Curl

LOS

L

C

R

QB

F

H

Flare

SPLIT TEE

Flare
Curl - FadeOUT - FLAG

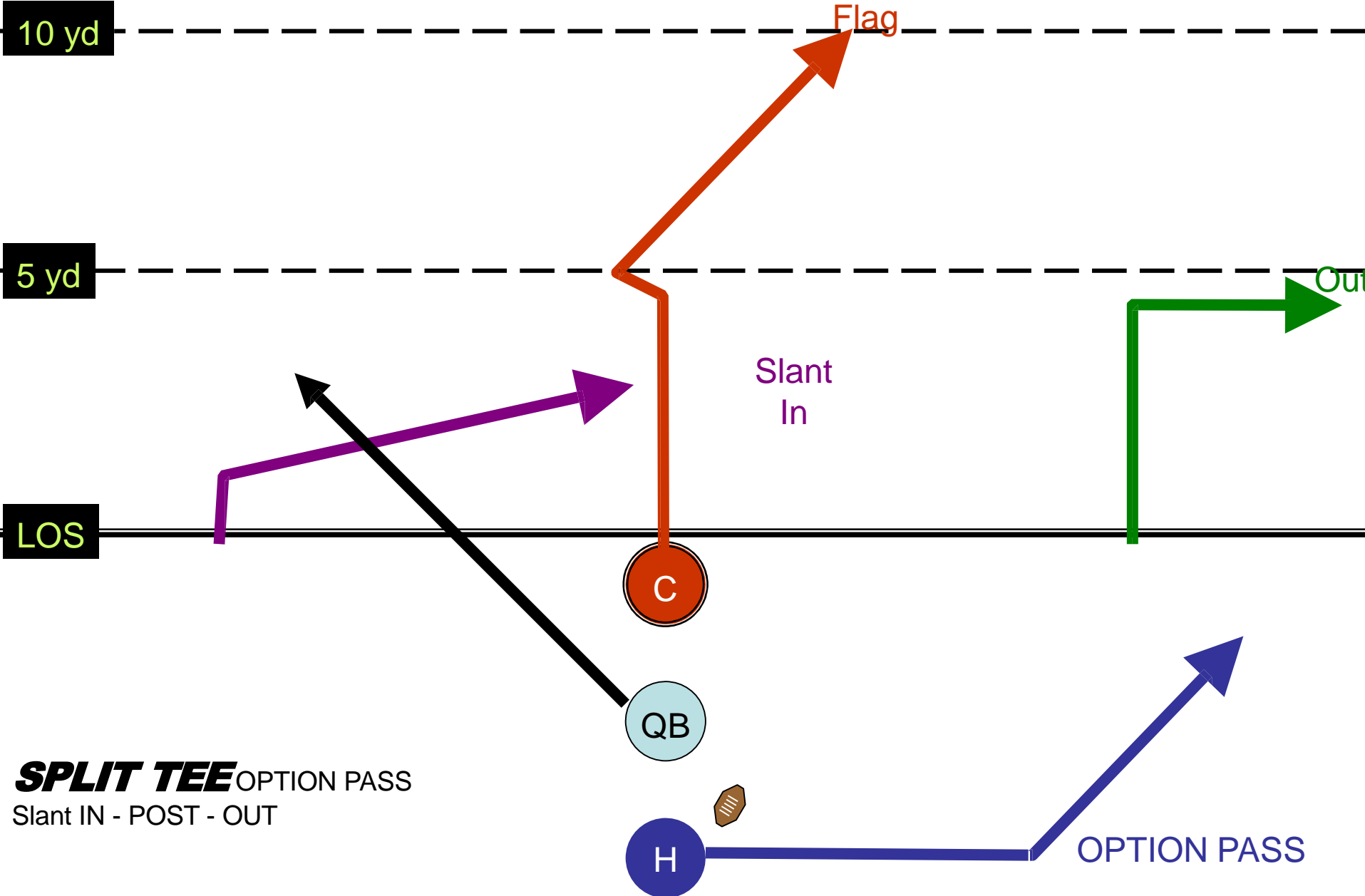

10 yd

5 yd

LOS

Flag

Out

Slant
In

C

QB

H

OPTION PASS

SPLIT TEE OPTION PASS

Slant IN - POST - OUT

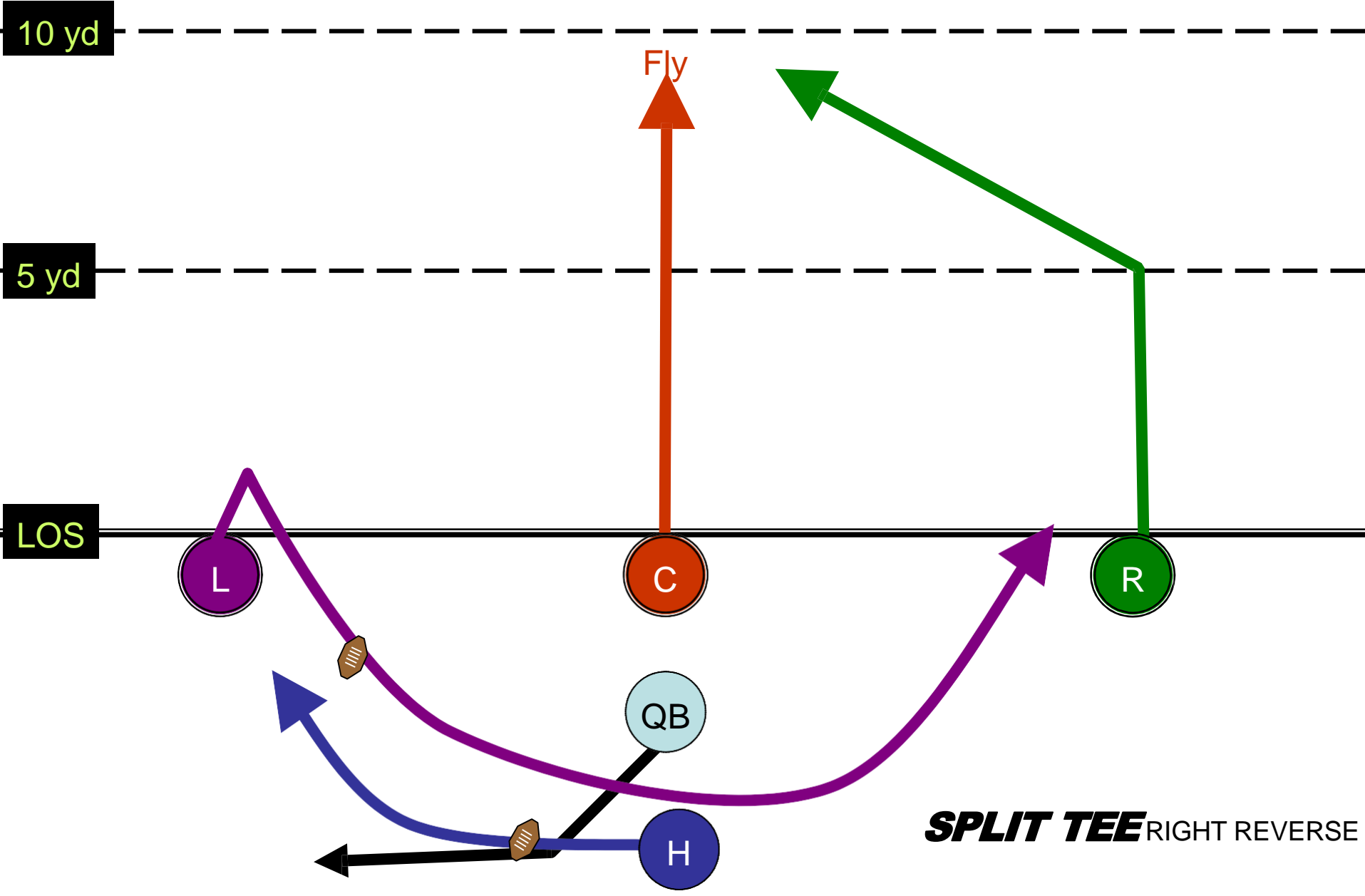

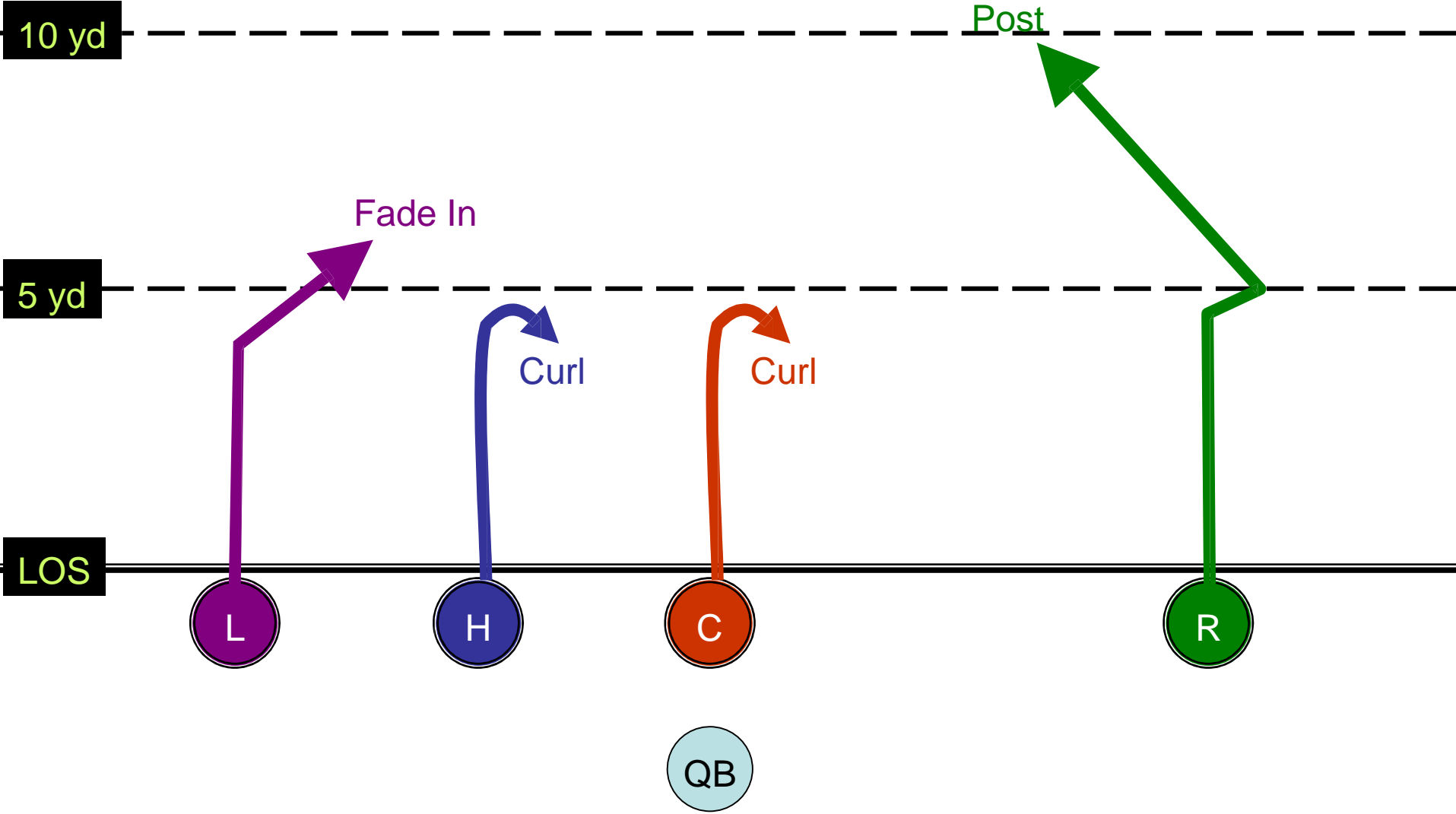

TWINS LEFT

FADE IN - DOUBLE CURL - POST

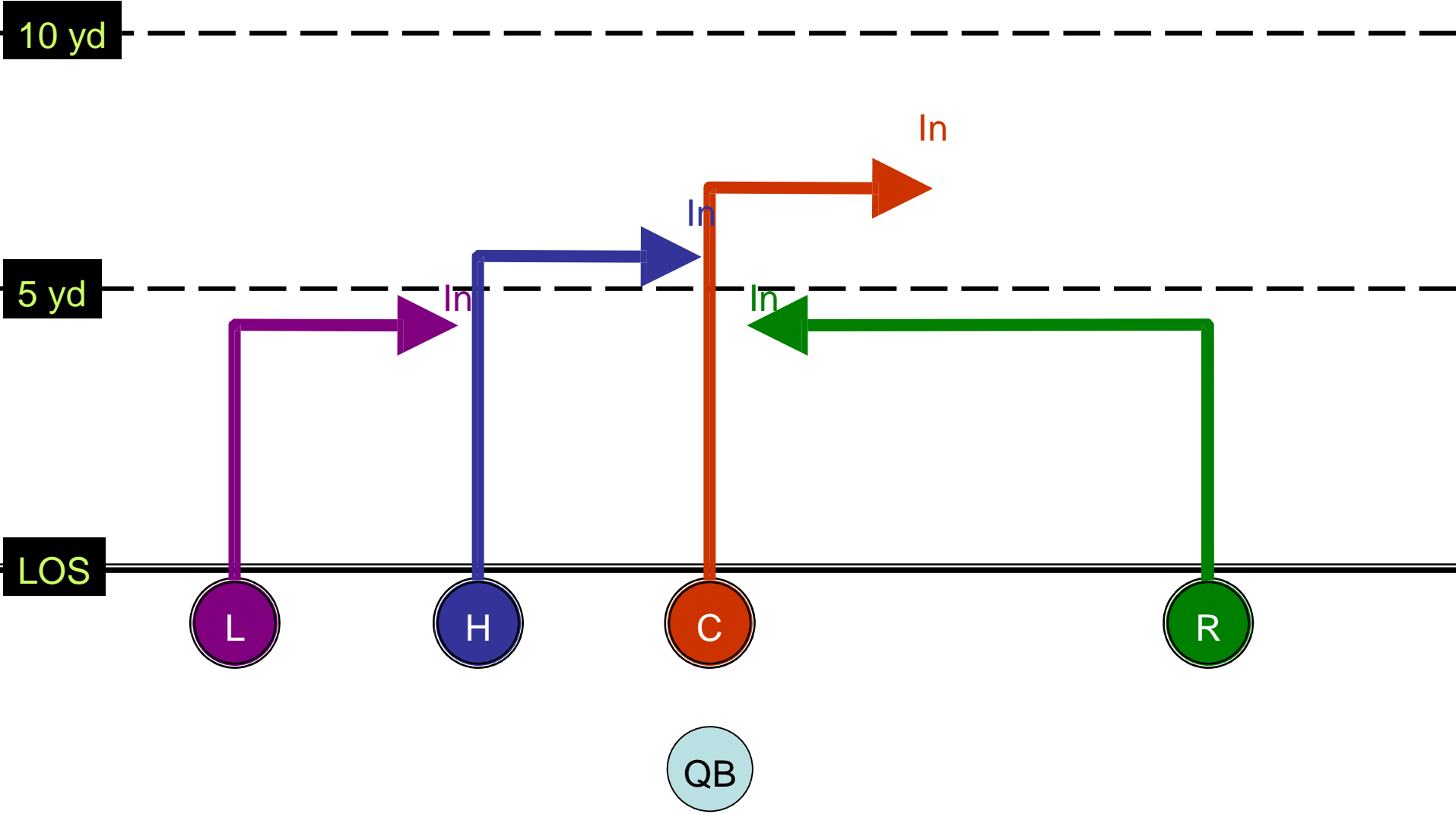

TWINS LEFT

INs

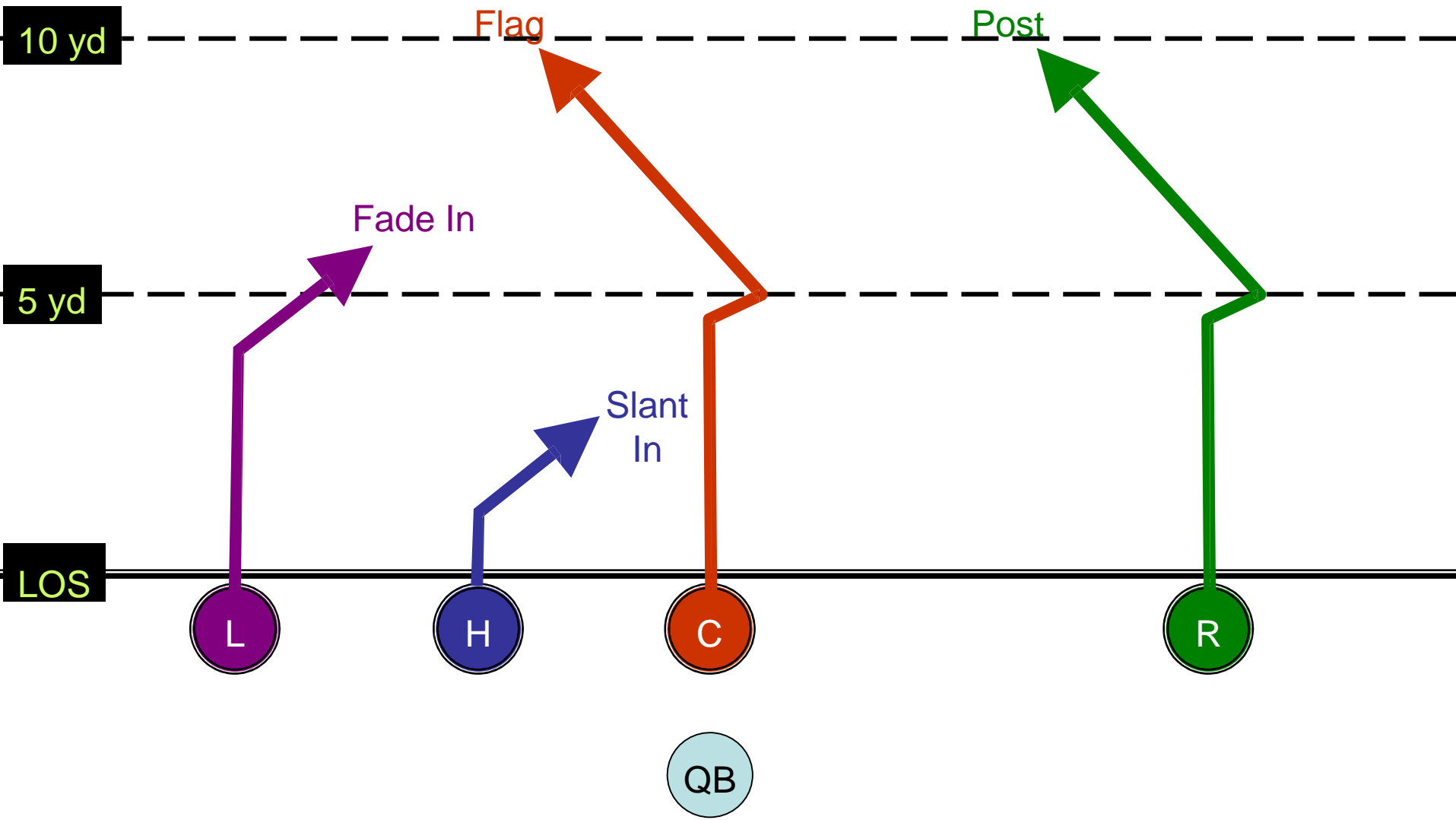

TWINS LEFT

FADE - SLANT IN - FLAG - POST

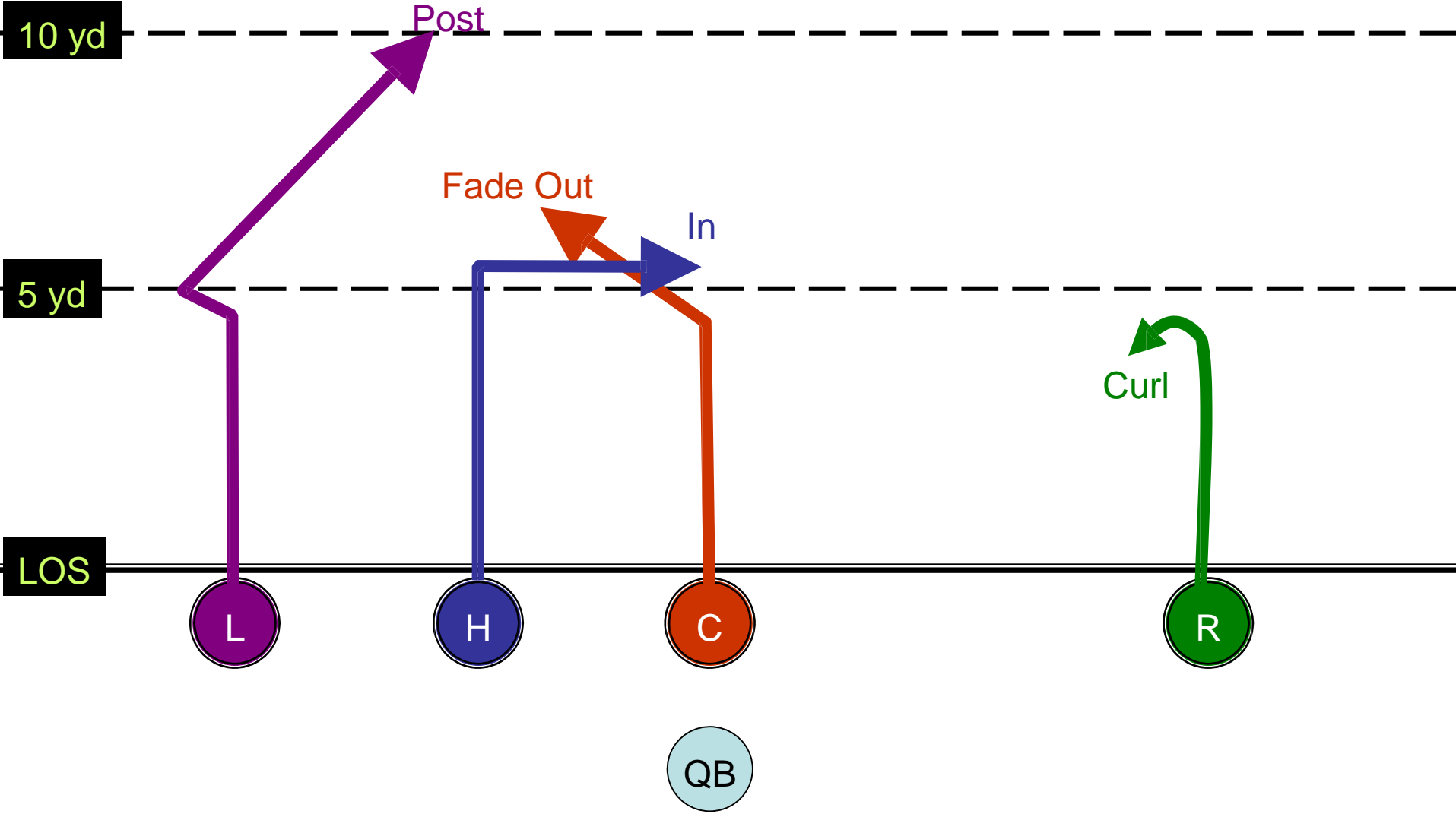

TWINS LEFT

Post – IN - FADE OUT - CURL

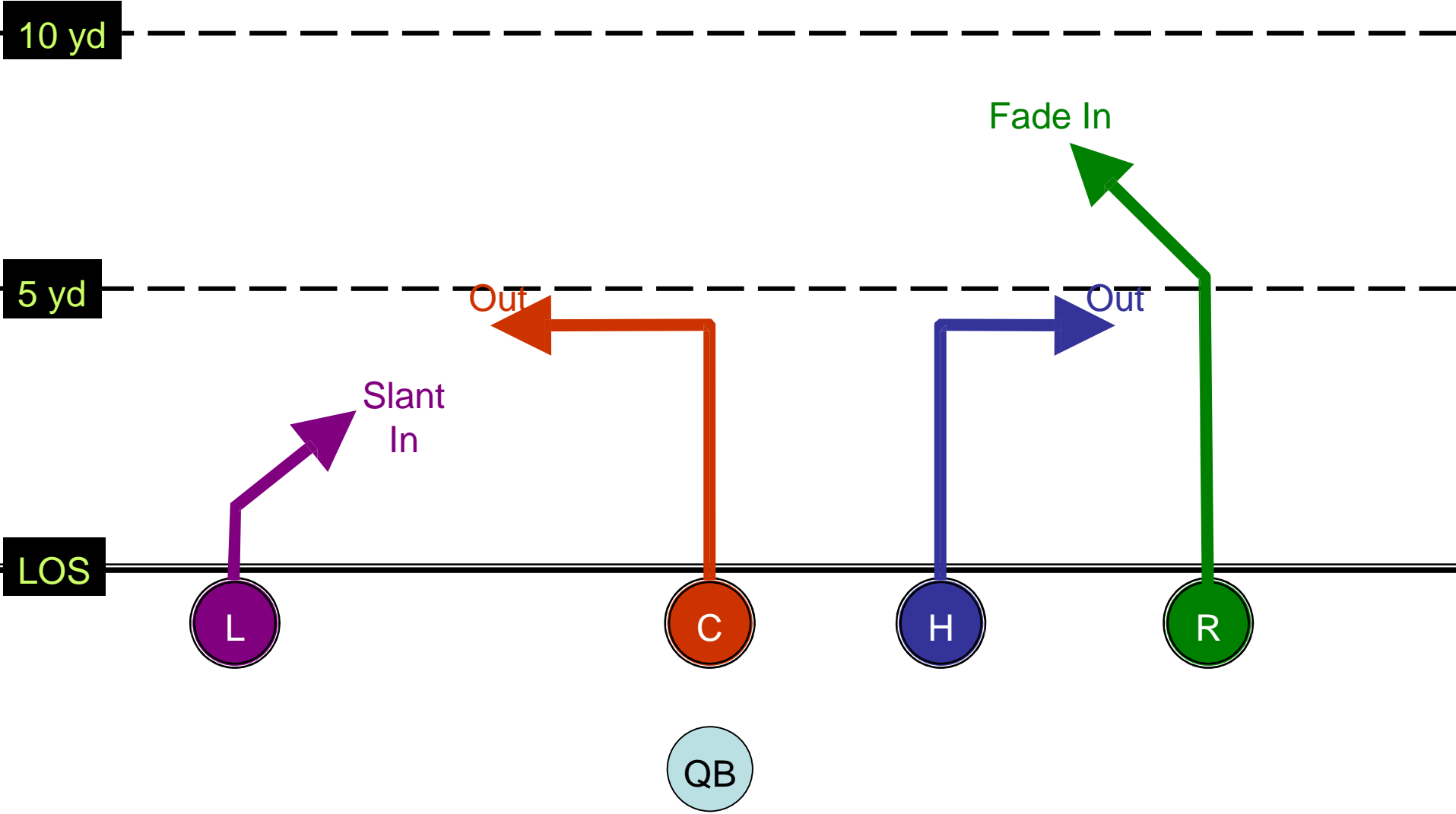

TWINS RIGHT

INS & OUTS

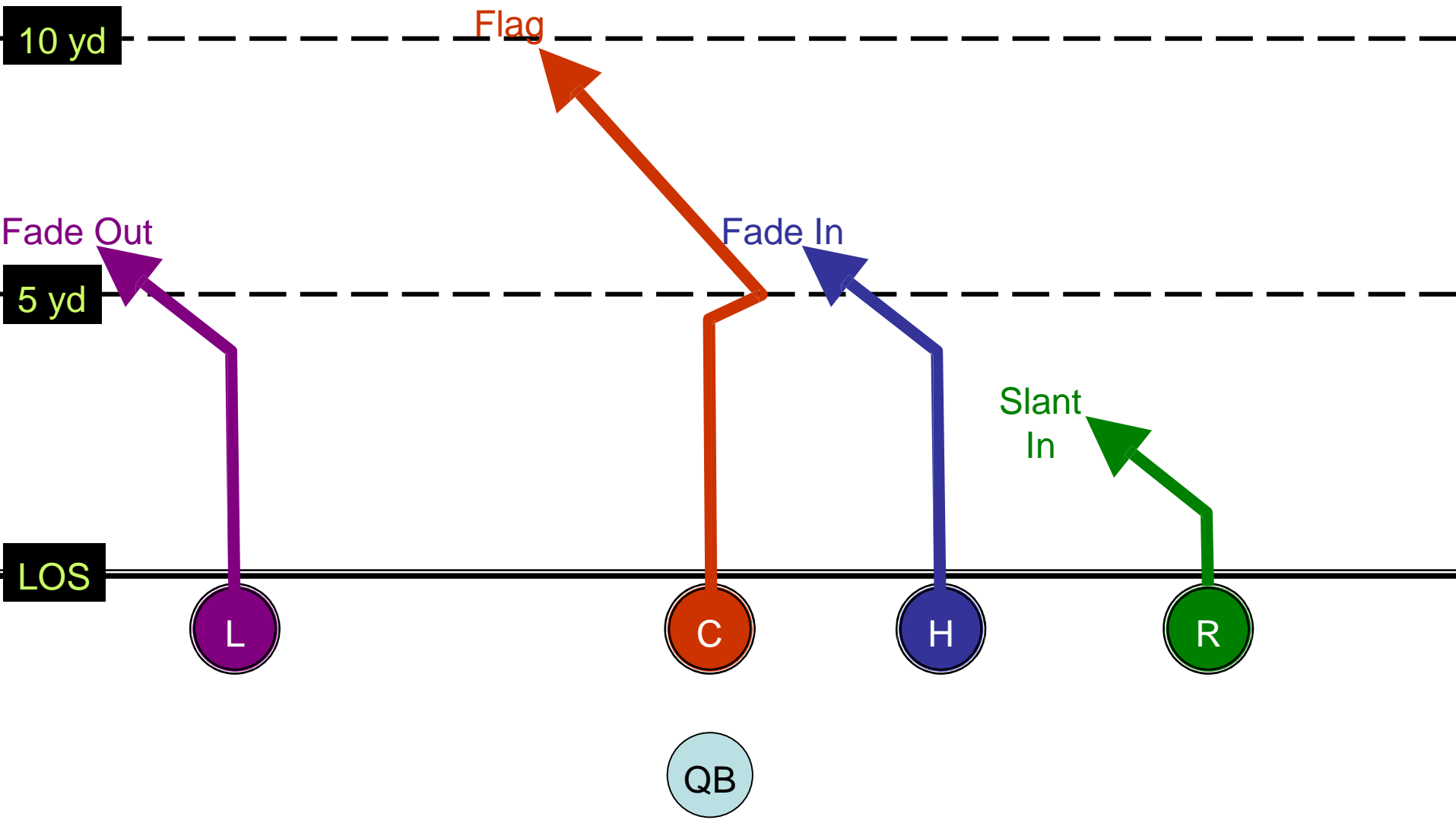

TWINS RIGHT

FADE OUT - FLAG - FADE IN - SLANT IN

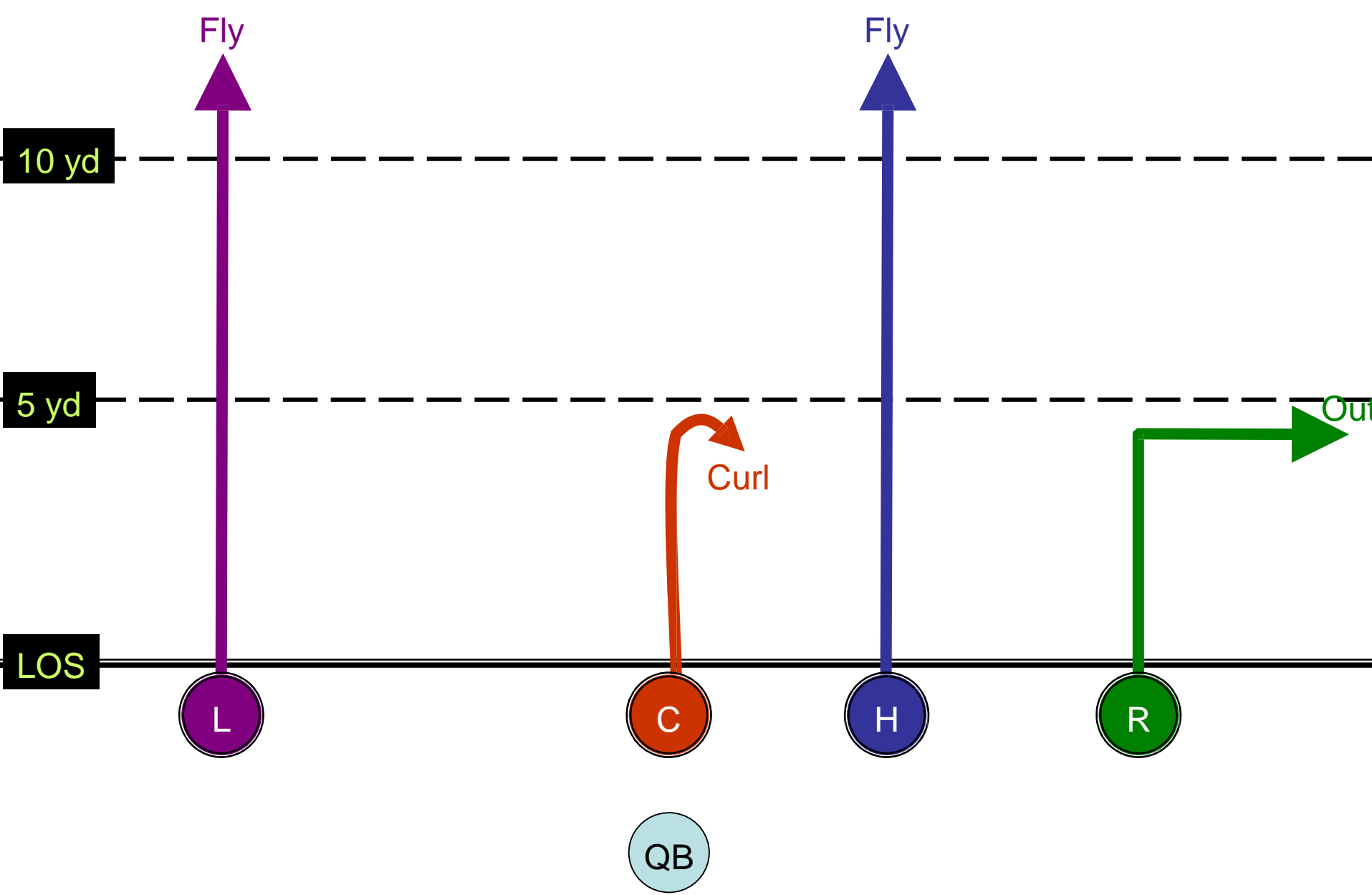

TWINS RIGHT

BOMB - CURL - BOMB - OUT

SHORT YARDAGE ONE POINT PAT

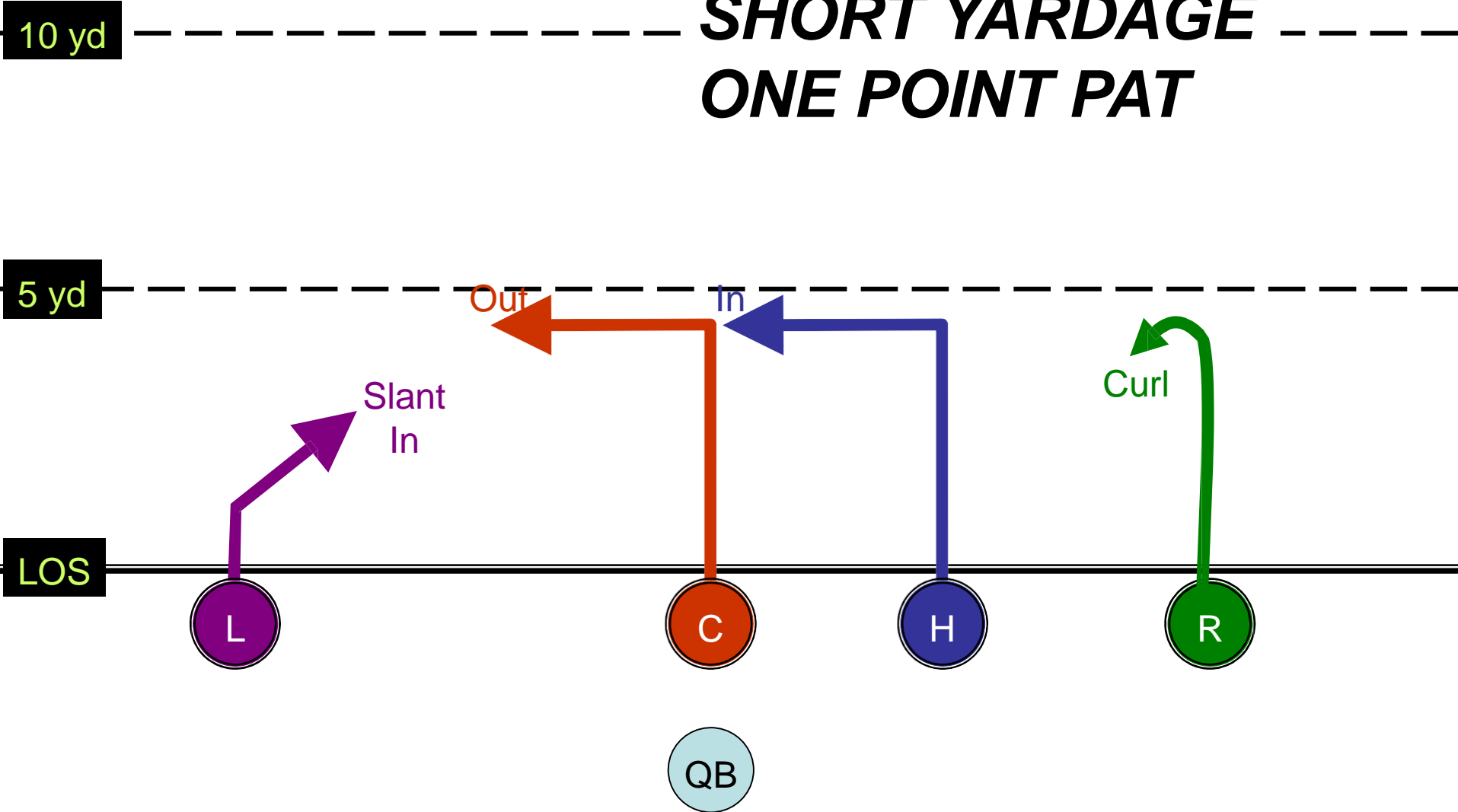

TWINS RIGHT

Slant In – OUT – IN - CURL

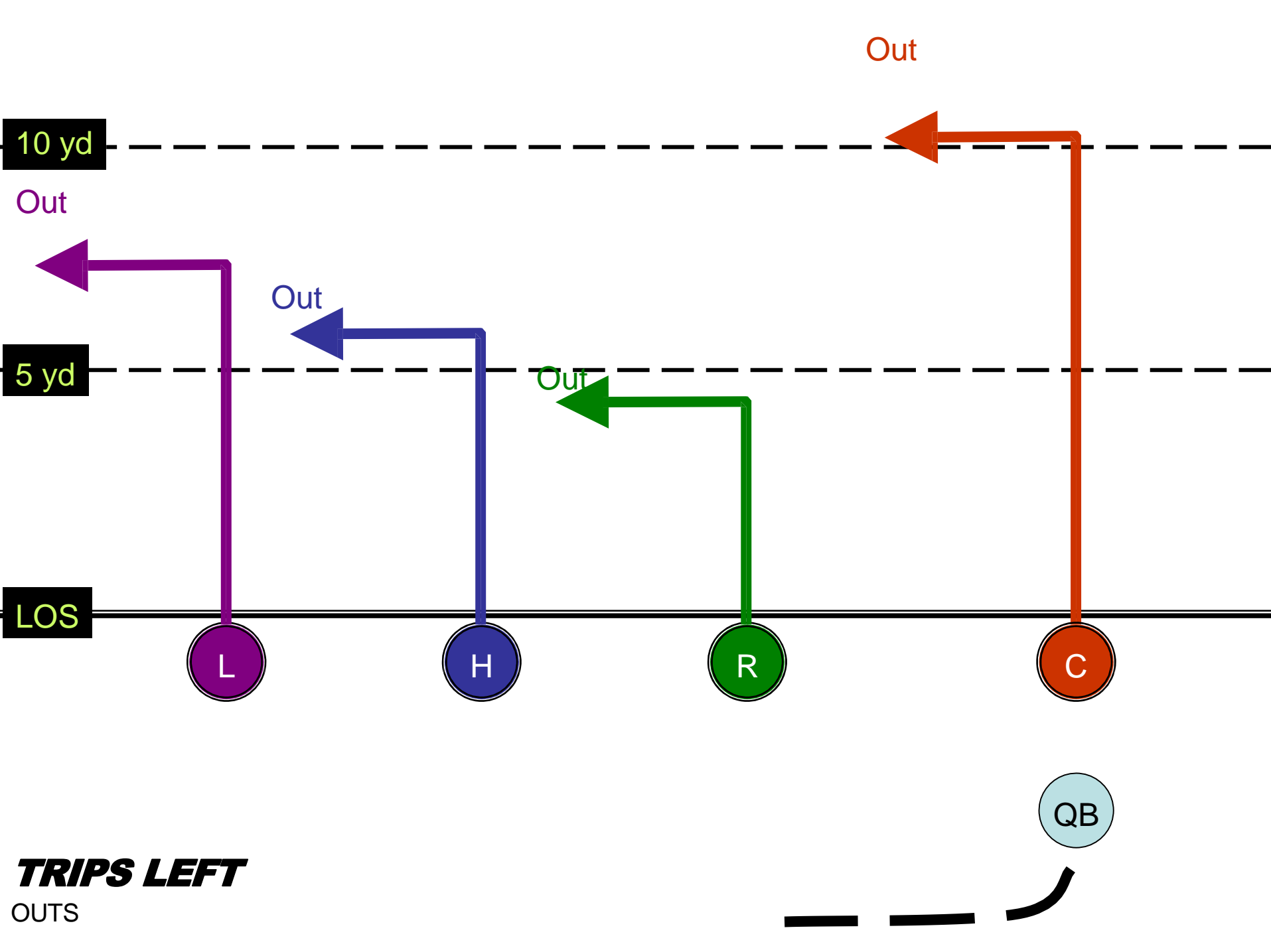

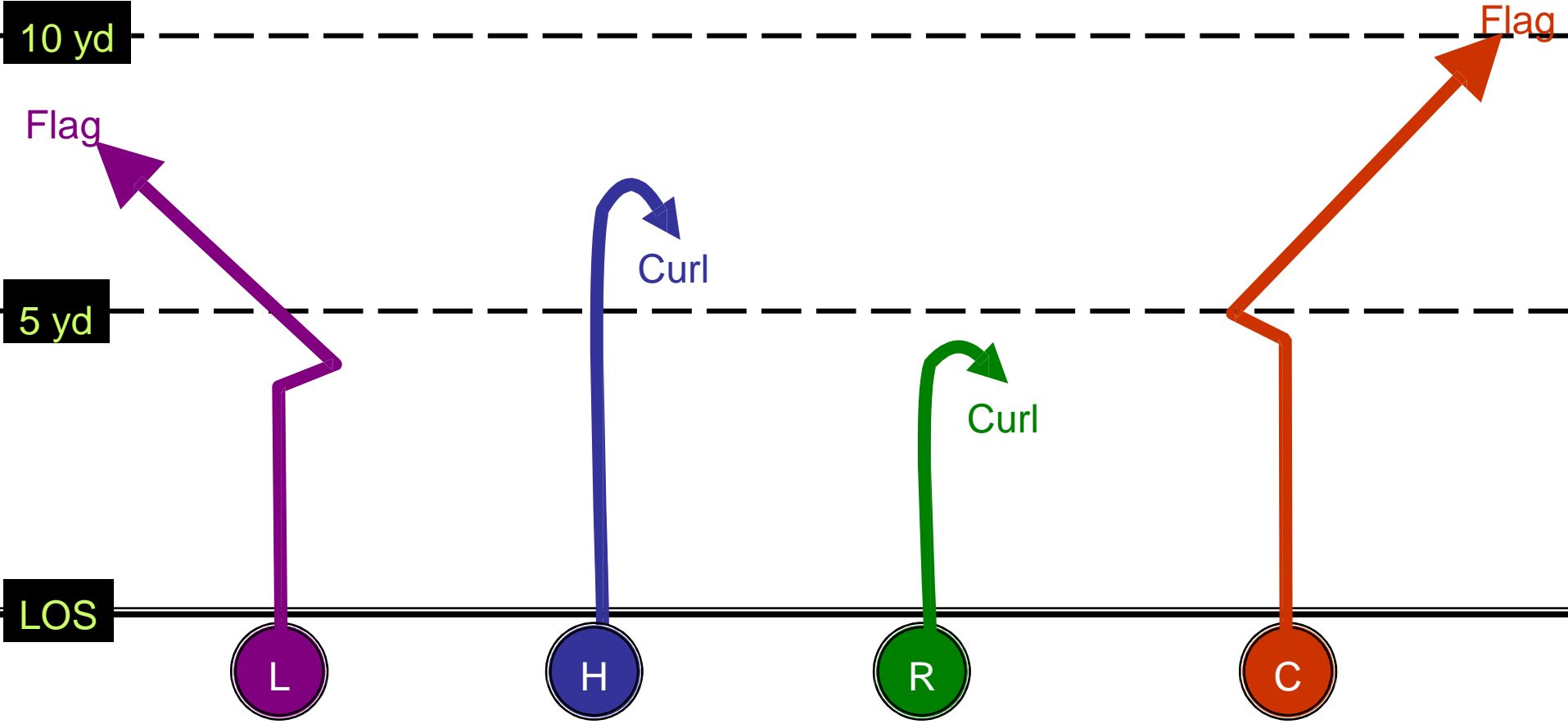

QB

TRIPS LEFT
DEEP & TIGHT



10 yd

5 yd

LOS

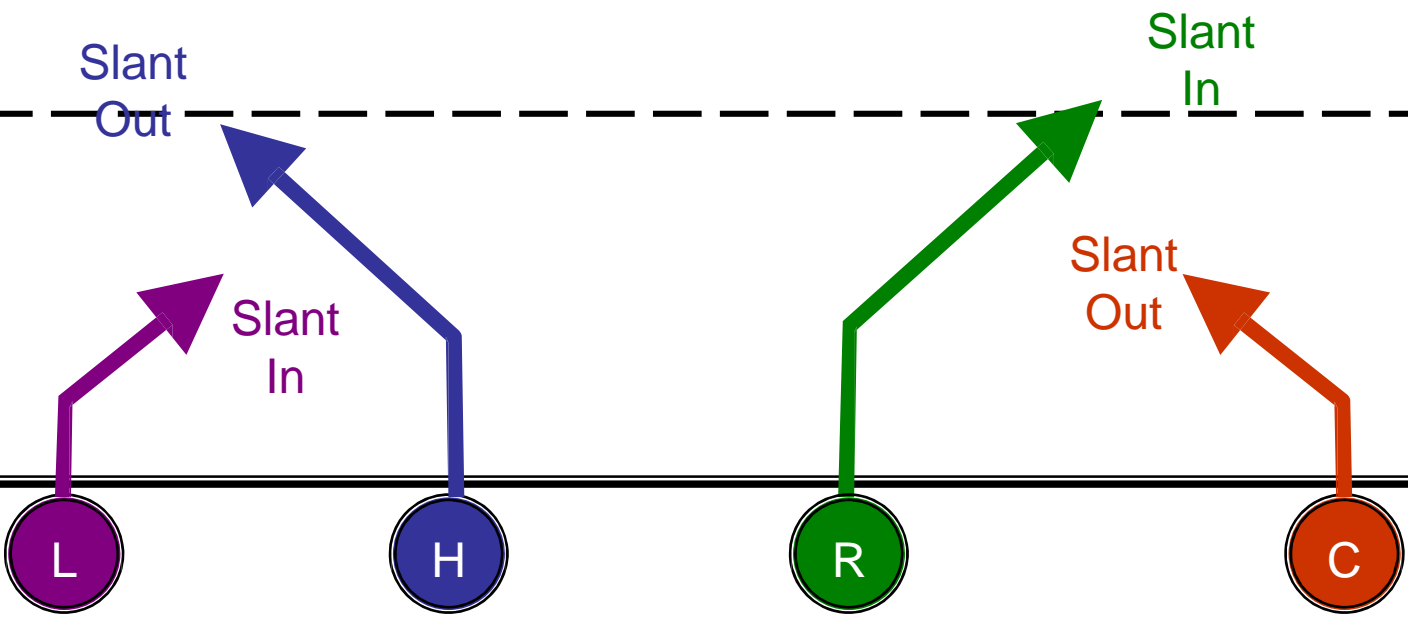

QB

TRIPS LEFT
SLANT INs & OUTs



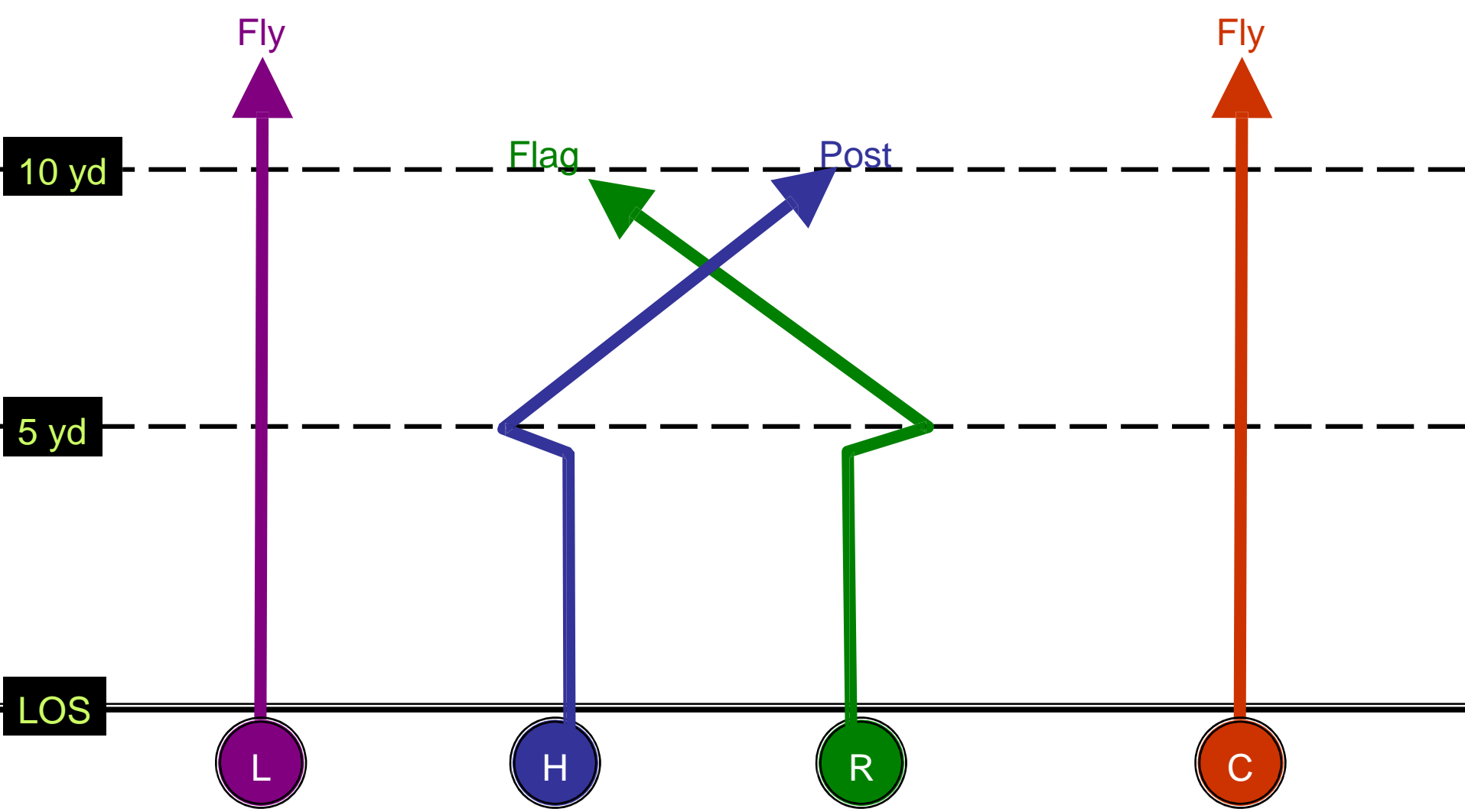

TRIPS LEFT
BOMBS AWAY



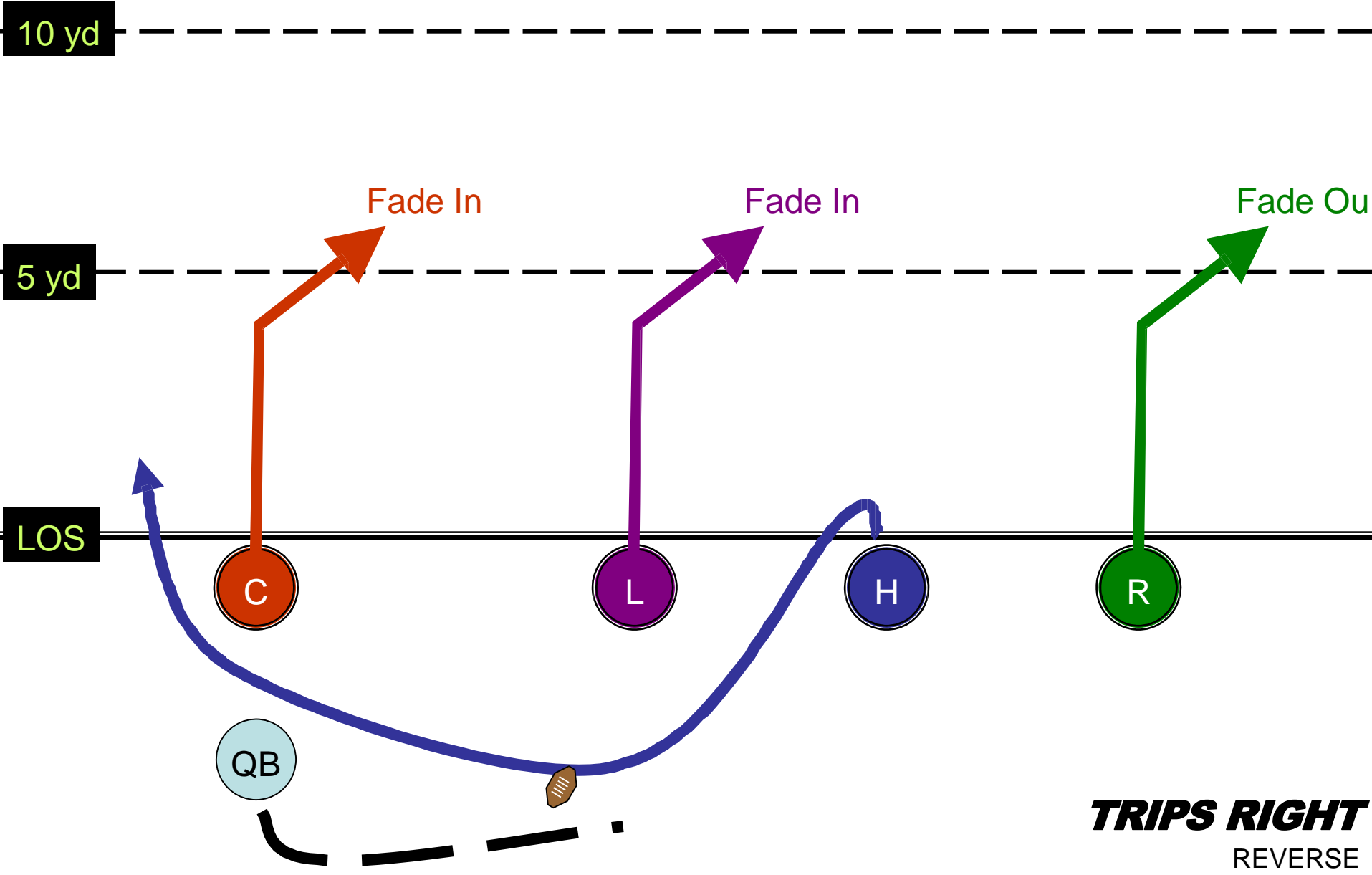

TRIPS RIGHT
REVERSE

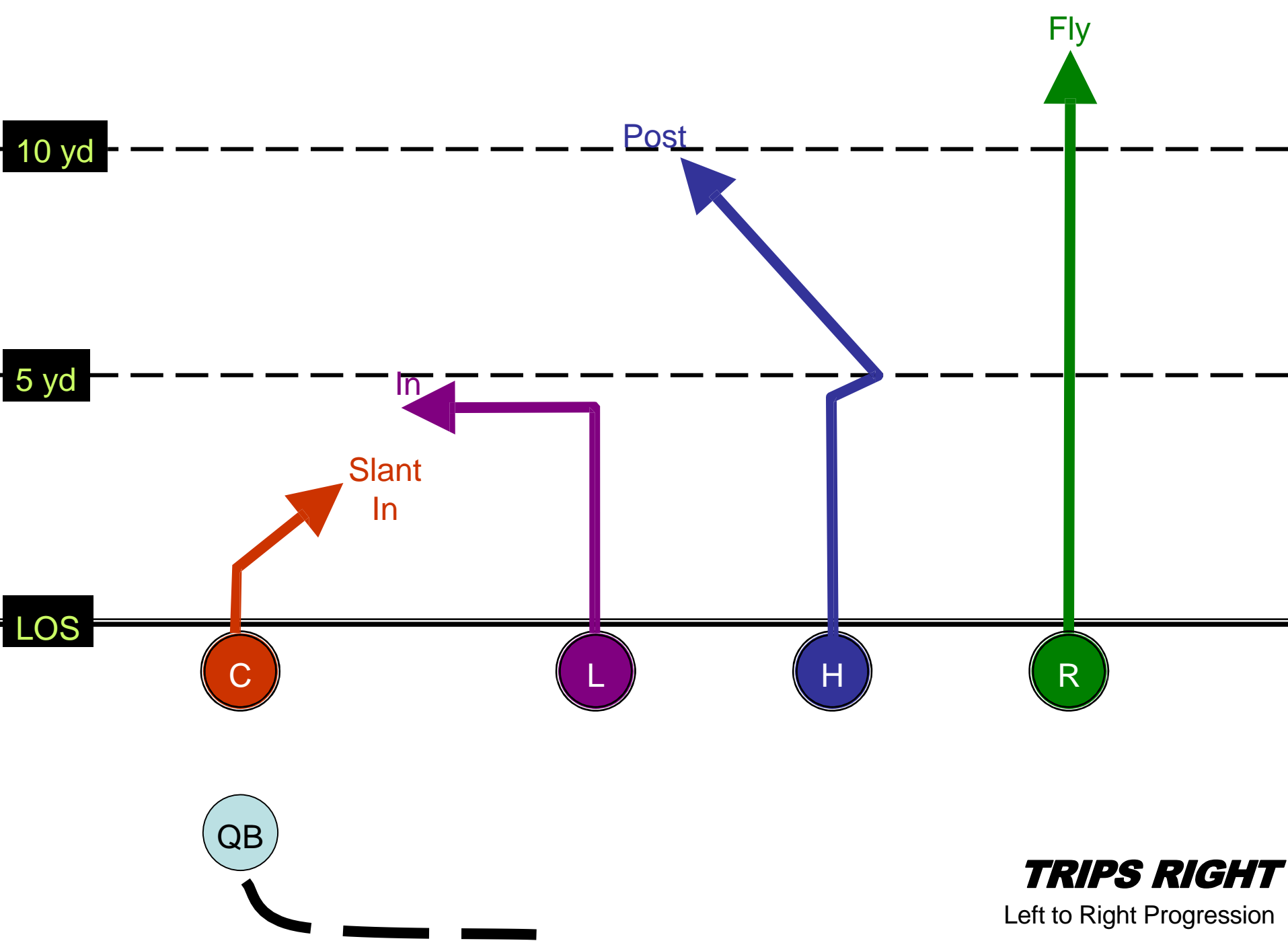

TRIPS RIGHT
Left to Right Progression

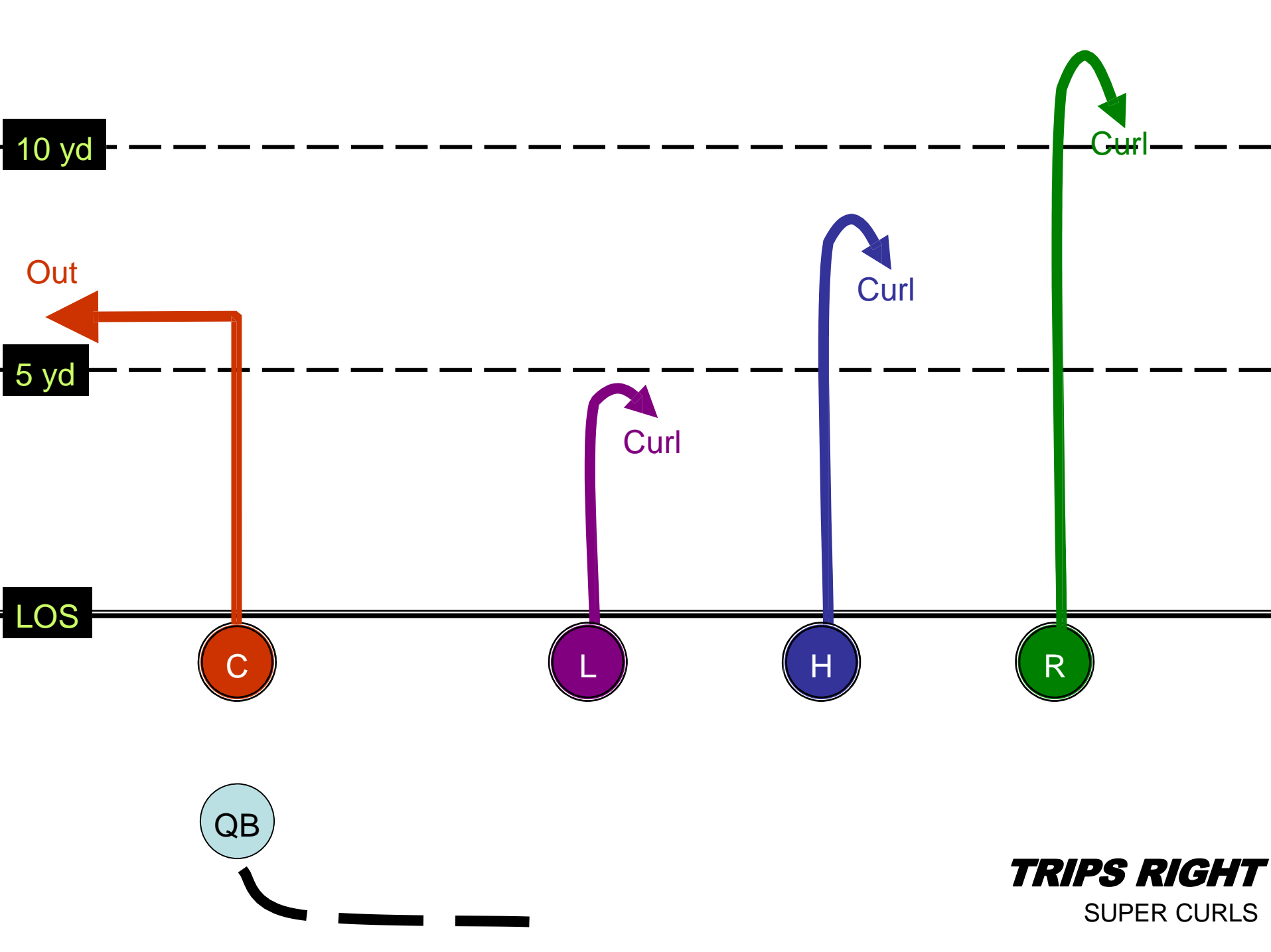

10 yd

5 yd

LOS

Out

Curl

Curl

Curl

C

L

H

R

QB

TRIPS RIGHT

SUPER CURLS

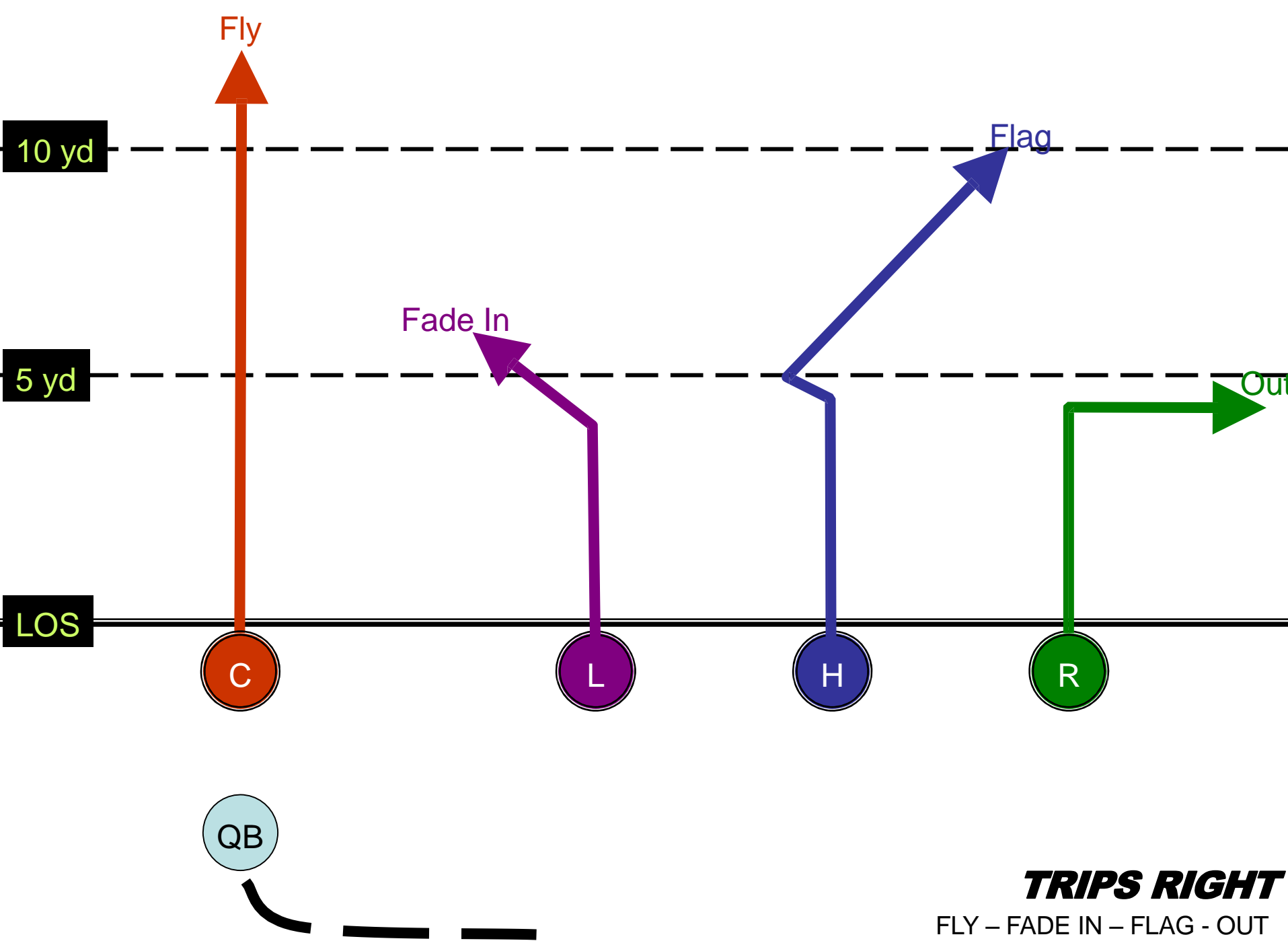

TRIPS RIGHT
FLY – FADE IN – FLAG - OUT

10 yd

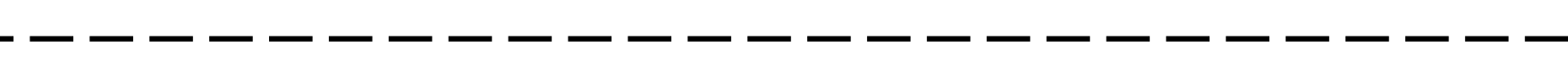

5 yd

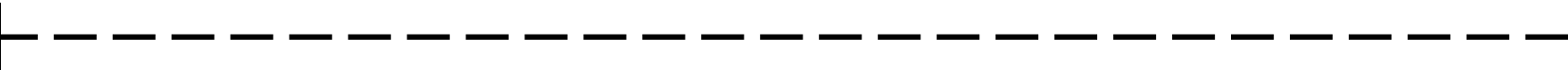

LOS

