

MITEL

Communications Director



5320 IP Phone User Guide



NOTICE

The information contained in this document is not warranted by Mitel Networks Corporation or any of its affiliates or subsidiaries ("Mitel") and is subject to change without notice. Mitel assumes no liability for any errors or omissions. This document may be reproduced, either wholly or in part, solely for distribution to authorized users of Mitel's products. In reproducing this document, content may be removed or reorder, provided the meaning is not altered. No other amendment to the document is permitted without written permission from Mitel.

TRADEMARKS

Mitel and Speak@Ease are trademarks of Mitel Networks Corporation.

Windows and Microsoft are trademarks of Microsoft Corporation.

Other product names mentioned in this document may be trademarks of their respective companies and are hereby acknowledged.

Mitel 5320 IP Phone - User Guide
October 2009

®,™ Trademark of Mitel Networks Corporation
© Copyright 2009, Mitel Networks Corporation
All rights reserved

IMPORTANT! This telephone is NOT suitable for direct connection to the public-switched telephone network. Connect the telephone to a Mitel Networks system only.

| | |
|---|-----------|
| ABOUT YOUR PHONE | 1 |
| Elements of Your Phone | 2 |
| Ring/Message Indicators | 3 |
| For Users on Resilient 3300 ICP Systems | 3 |
| TIPS FOR YOUR COMFORT AND SAFETY | 4 |
| Don't Cradle the Handset!..... | 4 |
| Protect your Hearing..... | 4 |
| Adjust the Viewing Angle | 4 |
| USING YOUR DEFAULT PHONE WINDOW AND KEYS..... | 5 |
| Getting Started with Your Phone | 5 |
| 5320 IP Phone Default Window and Keys..... | 6 |
| ABOUT YOUR PHONE APPLICATIONS | 7 |
| Using the Settings Application | 7 |
| Using the Call History Application..... | 8 |
| View Call Log Details | 8 |
| Review Call Log Icons..... | 9 |
| Delete Logs | 9 |
| Getting Help..... | 10 |
| Tips for Setting up Your Phone..... | 10 |
| CUSTOMIZING YOUR PHONE..... | 11 |
| Using the Dial Pad to Enter Information | 11 |
| Using the On-Screen Keyboard to Enter Information | 12 |
| Specify Language | 12 |
| Specify Display Contrast..... | 13 |
| Specify Audio Feedback Options..... | 14 |
| Specify Text Size | 14 |
| Specify Call Notification Behavior | 15 |
| Adjust the Ringer | 15 |
| Enable a Screen Saver..... | 16 |

| | |
|---|-----------|
| Enable PC Connectivity | 16 |
| PROGRAMING FEATURES ON YOUR KEYS | 17 |
| Tips on Programming Features | 17 |
| Features available for programming on programmable keys..... | 17 |
| Applications available for programming on programmable keys | 18 |
| Program Feature Keys Using the Settings Application..... | 19 |
| Clear Programming from a Key | 20 |
| MAKING AND ANSWERING CALLS | 21 |
| Phone Book | 21 |
| Answer a Call..... | 22 |
| End a Call | 22 |
| Redial..... | 22 |
| Redial - Saved Number | 22 |
| Handsfree Operation | 22 |
| Auto-Answer | 23 |
| CALL HANDLING | 24 |
| Hold | 24 |
| Mute..... | 24 |
| Transfer | 25 |
| Conference | 25 |
| Conference Split | 25 |
| Add Held | 25 |
| Swap..... | 26 |
| Call Forwarding..... | 26 |
| USING QUICK CALL FORWARD ALWAYS..... | 26 |
| PROGRAMMING CALL FORWARDING USING PROFILES..... | 27 |
| ACTIVATE CALL FORWARD | 28 |
| CANCEL CALL FORWARD | 28 |
| USING OTHER FEATURES..... | 29 |
| Account Codes | 29 |
| ACD | 29 |

| | |
|--|----|
| Attendant Call Hold - Remote Retrieve..... | 30 |
| Callback..... | 30 |
| Call Forward - Remote (I'm Here)..... | 30 |
| Call Forward - End Chaining..... | 31 |
| Call Forward - Forced..... | 31 |
| Call Forward - Override..... | 31 |
| Call Park..... | 32 |
| Call Pickup..... | 32 |
| Campon..... | 33 |
| Direct Paging..... | 33 |
| Direct Paging - Handsfree Answerback Enabled..... | 33 |
| Direct Paging - Handsfree Answerback Disabled..... | 34 |
| Direct Voice Call..... | 35 |
| Do Not Disturb..... | 36 |
| Emergency Calls..... | 36 |
| Group Listen..... | 37 |
| Group Paging / Meet Me Answer..... | 37 |
| Group Presence..... | 38 |
| Handoff - Personal Ring Groups..... | 39 |
| Headset Operation..... | 40 |
| Hot Desking..... | 41 |
| Hot Desk Remote Logout..... | 41 |
| Hot Desk - PIN Change..... | 42 |
| Make Busy..... | 42 |
| Message Waiting Indicator..... | 42 |
| Messaging - Advisory..... | 43 |
| Messaging - Callback..... | 43 |
| Messaging - Cancel Callback..... | 44 |
| Messaging - Cancel All Callbacks..... | 44 |
| Music..... | 45 |
| Night Answer..... | 45 |

| | |
|--------------------------|----|
| Override (Intrude) | 45 |
| Paging..... | 45 |
| Phone Lock..... | 46 |
| User PIN | 47 |
| Record-a-Call..... | 48 |
| Speak@Ease..... | 48 |
| Speed Call | 49 |
| Tag Call | 49 |
| Timed Reminder | 50 |
| Trunk Flash..... | 50 |

ABOUT YOUR PHONE











The Mitel® 5320 IP Phone is full-feature, dual port, dual mode enterprise-class telephone that provides voice communication over an IP network. It features a large graphics display (160 x 320) and self-labeling keys. The 5320 IP Phone offers seven programmable multi-function keys for one-touch feature access. It provides ten fixed feature keys for convenient access to features such as Conferencing, Redial, and many customizable user settings as well as navigational keys to access various screens and application layers. The 5320 also features a Mitel Unified Communicator® (UC) Express application, which is a PC-based desktop programming tool that allows you to easily configure your phone from your Personal Computer (PC).

The 5320 IP Phone supports Mitel Call Control (MiNet) protocol and session initiated protocols (SIP). It also supports Hot Desking and Clustered Hot Desking as well as Resiliency. The 5320 phone is ideal for executives and managers, and can be used as an ACD Agent or Supervisor Phone, as well as a Teleworker Phone.



The 5320 IP Phone

Elements of Your Phone

| Feature | Function |
|--|---|
| 1) Display | Provides a large, high-resolution viewing area that assists you in selecting and using phone features. |
| 2) Ring/Message Indicator | Flashes to signal an incoming call and to indicate a message waiting in your voice mailbox. |
| 3) Volume, Speaker and Mute Controls | Provides the following audio control capability: <ul style="list-style-type: none">  (UP) and  (DOWN) provide volume control for the ringer, handset, and handsfree speakers.  (SPEAKER) enables and disables Handsfree mode.  (MUTE) enables Mute, which allows you to temporarily turn your phone's handset, headset or handsfree microphone off during a call. |
| 4) Fixed Function Keys | Gives you access to the following phone functions: <ul style="list-style-type: none">  (APPLICATIONS): provides access to menus for your phone's applications and settings.  (CANCEL): ends a call when pressed during the call, and, when you are programming the phone, eliminates any input and returns to the previous menu level.  (REDIAL): calls the last number dialed.  (HOLD): places the current call on hold.  (TRANS/CONF): initiates a call transfer or establishes a three-party conference call.  (MESSAGE): provides access to your voice mailbox and flashes to notify you of messages waiting in your voice mailbox. Note: The Ring/Message indicator also flashes when messages are waiting. |
| 5) Keypad | Use to dial. |
| 6) Navigation Page Keys | Use to display additional pages of information for certain applications. The 5320 has two page navigation keys: Back and Next. |
| 7) Programmable Feature Keys and Softkeys. | Provides 7 self-labeling keys that can be programmed as speed call keys, fixed function keys, hard keys, applications, or line appearance keys, according to your communication needs. On your home page, the bottom left feature key is always your Prime Line key. The top three keys are softkeys. |
| 8) Handsfree Speaker | Provides sound for Handsfree calls and background music. |
| 9) Handset | Use for handset calls. If you are in headset or handsfree mode, you do not need to use the handset. |

Ring/Message Indicators

| When indicator is | it means that |
|-------------------|--|
| Flashing rapidly | Your phone is ringing |
| Flashing slowly | A message or callback message is waiting at your phone |
| On | Your phone is ringing another phone |
| Off | Your phone is idle, or you are on a call |

For Users on Resilient 3300 ICP Systems

If during a call, you hear a beep repeated every 20 seconds it means that your phone is switching to a secondary 3300 ICP system. The call continues and there is a change in the operation of some keys and features on your phone. Normal operation resumes when your phone switches back to the primary system. If your phone is idle and switched to the secondary system, you'll see a flashing rectangle on the display. The rectangle remains until the switch to the primary system is complete.

If the phone fails over to the secondary ICP, you have access to your mailbox on the secondary ICP only if your Administrator has programmed a mailbox for you.

Notes:

- The mailbox on the secondary ICP will not contain the same messages as the mailboxes on the primary ICP. Any preferences that are voice mail related are not carried from the primary ICP to the secondary ICP. These preferences must be set on both ICPs.
- The Settings application does not support resiliency. Your logs, contact information and any Settings on the primary ICP will not be carried from the primary ICP to the secondary ICP.

TIPS FOR YOUR COMFORT AND SAFETY

Don't Cradle the Handset!

Prolonged use of the handset can lead to neck, shoulder, or back discomfort, especially if you cradle the handset between your ear and shoulder. If you use your phone a lot, you may find it more comfortable to use a headset. See the section on headset usage elsewhere in this guide for more information.

Protect your Hearing

Your phone has a control for adjusting the volume of the handset receiver or headset. Because continuous exposure to loud sounds can contribute to hearing loss, keep the volume at a moderate level.

Adjust the Viewing Angle

The stand built into your phone tilts to give you a better view of the keys.

To tilt your telephone for better viewing:

1. Turn the phone so that the front faces away from you.
2. Hold the base unit firmly and press the release tabs on the sides of the stand to detach the base unit.
3. Hinge the hooks of the base unit into the notches on the back of the phone and snap into place as follows:
 - a. For a high-angle mount, hinge the two lower hooks into the bottom set of notches and snap the two upper hooks into the middle set of notches.
 - b. For a low-angle mount, hinge the two lower hooks into the middle set of notches and snap the two upper hooks into the top set of notches.

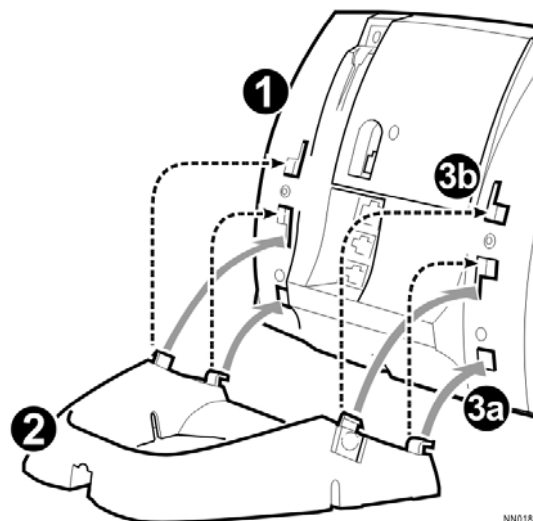

NN0183

USING YOUR DEFAULT PHONE WINDOW AND KEYS

The 5320 IP Phone's default phone window and keys are shown and described below. The Phone window provides access to programmable keys and the main phone interface.



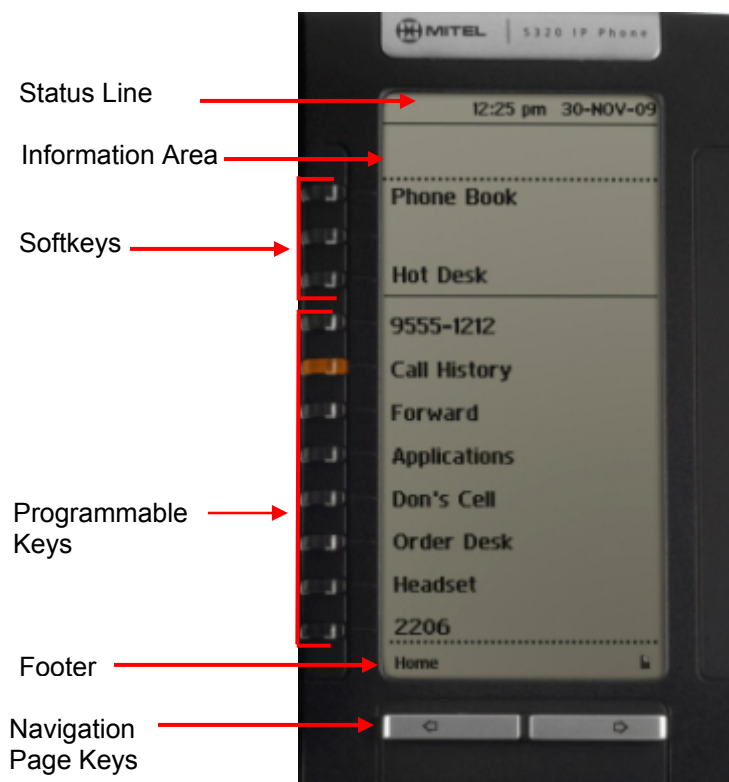

Getting Started with Your Phone

When you receive your phone, you need to program features and applications. Press the **Applications** key  to access your phone's applications and settings. You can then program your phone's settings. See [Using Your Phone Applications](#).



5320 IP Phone Window

5320 IP Phone Default Window and Keys

| Feature | Function |
|-------------------------|--|
| 1) Softkeys | Allow you to access specific call control features, which are context sensitive. Non-programmable feature keys, which are specific to the application or state of the set. The 5320 provides three softkeys. |
| 2) Programmable Keys | Launch specific call control features. Use the <i>Settings</i> application or the UC Express application to program these keys. The 5320 provides 7 programmable keys plus 1 prime line key. For instructions on programming the keys, see Programming Features on Your Keys . |
| 3) Navigation Page Keys | Display additional pages of information. The 5320 has two page navigation keys: Back and Next. |
| 4) Status Line | <p>Displays time, date, and icons indicating feature states as follows:</p> <ul style="list-style-type: none"> • Message Waiting () - Indicates new voice mail. • Headset () - Indicates that the phone is in headset mode. • DND () - Indicates DND (Do not disturb) mode. • Logged in as () - Indicates that a hot desk user is logged in. |
| 5) Information Area | Provides prompts in most phone applications. Content changes based on the application. |
| 6) Footer | Shows context and summary information based on information in the Programmable Keys area, such as Page Indicators, numbers of items, and so forth. |

ABOUT YOUR PHONE APPLICATIONS

Your 5320 IP Phone provides applications that simplify the use of your phone.

To open the Applications window, press the **Applications**  key. The menu home window gives the current status of your phone's applications. To open an application, press the key beside the application name:

- **Call Forwarding:** Use the *Call Forwarding* application to quickly set Call Forward Always and to create Call Forward profiles that identify where to send your incoming calls. The Call Forwarding window shows a list of your Call Forwarding profiles and indicates which one is active. See [Call Forward](#) for more information on how to add, edit, delete, and activate Call Forwarding profiles.
- **Call History:** Use the Call History application to display lists of the calls that you have missed, made, and answered. This feature allows you to filter the call records and display information on each call on the list. See [Using the Call History Application](#) for more information.
- **Settings:** Use the *Settings* application to display and quickly change your phone's current communications settings. See [Using the Settings Application](#) for more information.
- **Help:** Provides access to Launch PC Help and Quick Help and displays a list of the key icons.
- **Call Info:** Use the *Call Info* application to display caller information on your phone's prime line. Call Info appears automatically on incoming calls if the Call Notification—Display Call Info Setting is enabled and Call Info is available.

You can press the programmed application key from the default Phone Window. For information on programming keys, see [Programming Features On Your Keys](#).

Using the Settings Application

The *Settings* application provides a single location to access all your phone settings. Select any of the options below to access a window where you can view and configure settings for your phone. The Settings window provides the following:

- **Languages:** Allows you to select the language in which phone prompts and applications appear. Supported languages are English, French, Spanish, German, Dutch, Italian, and Portuguese. **Note:** The system can support up to three languages at one time. Language choices appearing in the phone display are controlled by ICP programming.
- **Text Size:** Allows you to specify the font size (large or small) for the 5320 IP Phone.
- **Programmable Keys:** Use to assign features to the Programmable Keys that are available in the *Phone* application.
- **Call Notification:** Use to specify that the *Phone* application behavior when incoming or outgoing calls occur.
- **Contrast:** Allows you to adjust the display contrast of your phone.

- **Screen Saver:** Allows you to specify a specific time of inactivity on your phone that triggers the screen saver to display.
- **Audio Feedback:** This setting allows you to adjust the volume of the audio feedback as well as the error beeps and enable or disable the setting.
- **Message Key Configuration:** Allows you to configure the Message  key.
- **PC Connectivity:** Allows you to enter a password that is used by the phone to establish communications with the PC-resident UC Express application.
- **About 5320 IP Phone:** This screen displays the software release.

Using the Call History Application

Use this application to display logs of your most recent 50 calls. After the 50-call limit has been reached, the oldest log is replaced each time a new call is missed, made, or answered.



From this application, you can

- display logs by type
- display call information (if available) for the logs
- return missed calls by pressing a key
- delete or modify digits before saving or dialing a call
- delete logs



If you are a hot-desk user, you can view and maintain your call history logs when you are logged into another extension.

View Call Log Details

1. From the idle display, press the **Applications**  key and then press Call History. (Missed Calls) appears next to the key label if you have missed calls.
2. Press
 - **Missed** to view your missed calls (if any).
 - **Answered** to view logs of your incoming calls
 - **Made** to view logs of your outgoing calls.
3. Use the navigation keys at the bottom of the display to move to the previous, first, or next page of logs. The total number of logs in the current list is shown in the bottom left corner of the display. The bottom right corner shows the range of logs (for example 1 -7) that are currently displayed.
4. Press the key to the left of the log to display the call details:
 - Name and number (if available)
 - Log type and number of attempts (for example 2x)

- Type of call: Transfer (Tsf.) or Conference (Conf.)
 - Time and date of log
 - Duration of call in hours:minutes:seconds (for Made and Answered logs).
5. Do one of the following:
- If necessary, use the keypad, **Delete Digit**, and **Backspace** keys to modify the number. If an outgoing prefix is required to access an external trunk, you must add the digit(s). Press **Dial** to call the number.
 - Press  or  at the bottom of the set to display details for another log.
 - Press **Close** to return to the previous list.

Review Call Log Icons

1. Press the **Applications**  key, press **Help**, and press **Key Icons**.
2. Press  or  to navigate to the list of Call History icons. Note that “New” logs are any logs that have been generated since the last time you accessed the Call History application.

Delete Logs



To delete an individual log press the key to the left of the log to display the call details and then press **Delete Log Entry**.

To delete all logs by type

1. From the idle display, press **Applications**  key and then press **Call History**.
or
Press the Call Hist feature access key. (**Missed Calls**) appears next to the key label if you have missed calls.
2. Press
 - **Missed** to view your missed calls (if any)
 - **Answered** to view logs of your incoming calls
 - **Made** to view logs of your outgoing calls.
3. Press **Delete List** to delete all logs from the currently displayed list.
4. You are prompted to confirm the delete. Press **Delete**.

Getting Help

To access the 5320 IP Phone help and documentation:

1. Press the **Applications**  key.
2. Press Help. You have the following options:
 - Press **Launch PC Help** to display <http://edocs.mitel.com>.
 - Press Key Icons or Quick Help.
 - Press  or  at the bottom of the set to view items for the selected help option.
3. Press **Close**.

Tips for Setting up Your Phone

After you receive your 5320 IP Phone, use the options in the *Settings* application to customize your phone. After customizing your phone, press the **Applications**  key to verify the settings are correct. Now, you are ready to begin using your phone.

CUSTOMIZING YOUR PHONE

Use the *Settings* application to customize your phone.

 **Note:** The System Administrator can invoke a Lock to Factory default option on a per-phone basis. When this is in effect, the system administrator sets the settings for Programmable Keys and you cannot change them.



Using the Dial Pad to Enter Information

You can use the standard dial pad keys 0-9, and * and # to enter a name and or number for applications and features. Using the dial pad is the default option. You can also use the on-screen keyboard by selecting **Keyboard** while entering text (see [Using the On-screen Keyboard](#)).

The following table illustrates the characters you can enter by pressing a key consecutively. For example, to enter the letter “e”, press the ‘3’ key twice.

| Key | Characters | | | | | | | | | |
|-----|------------|-------|---|---|---|---|---|---|---|--|
| 1 | 1 | | | | | | | | | |
| 2 | a | b | c | A | B | C | 2 | | | |
| 3 | d | e | f | D | E | F | 3 | | | |
| 4 | g | h | i | G | H | I | 4 | | | |
| 5 | j | k | l | J | K | L | 5 | | | |
| 6 | m | n | o | M | N | O | 6 | | | |
| 7 | p | q | r | s | P | Q | R | S | 7 | |
| 8 | t | u | v | T | U | V | 8 | | | |
| 9 | w | x | y | z | W | X | Y | Z | 9 | |
| 0 | 0 | | | | | | | | | |
| * | * | Space | | | | | | | | |
| # | # | . | , | (|) | + | | | | |



Characters are automatically inserted after a one-second delay. If you make an error, use **Backspace** to make corrections.

Press  or  at the bottom of the set to move the cursor forwards or backwards without deleting characters.

 **Note:** When a text entry window is open, you cannot use the dial pad for dialing.

Using the On-Screen Keyboard to Enter Information

The onscreen keyboard can be used to enter name and number information into applications and features.

1. When prompted to enter name/number information, press **Keyboard** to display the on-screen keyboard.
2. Press **Next Page** and **Previous Page** to navigate to the set of characters needed for your input.
3. Repeatedly press the key next to the character you want to enter until that character is highlighted. The character is automatically inserted after a one-second delay. If you make an error, press  or  at the bottom of the set to move the cursor backwards or forwards. This does not delete any characters. You can press **Backspace** to delete characters.
4. After you have entered all the characters, press **Save**.
5. Continue with text entry as required by the application or press **Close**.

Specify Language

To specify the language in which prompts and applications display:

1. Press **Applications**  key.
2. Press **Settings**.
3. Press the **Language** setting.
The phone displays the three language selections that are currently programmed in the ICP.
4. Select the appropriate language and press **Save**.
The phone displays your chosen language.

 **Note:** Languages supported on the 5320 may differ from those supported on the ICP. If the phone is configured for an unsupported language, the prompts may appear in your selected language but the Application language for the phone defaults to English. The Language window displays "(name of the selected language)(Unsupported)".

Specify Display Contrast

You can adjust the display contrast either via the phone volume controls (when the phone is idle) or via the *Settings* application.

To adjust the display contrast using the volume controls:

- Repeatedly press  (UP) or  (DOWN).

 **Note:** You can use this method only when the phone is idle. If the phone is ringing, this action adjusts the ring volume. If the phone is in use, this action adjusts the handset, headset and speakerphone volume.

To adjust the display contrast using the *Settings* application:

1. Press **Applications**  key.
2. Press **Settings**.
3. Press **Contrast**.
4. Press the Contrast keys to adjust the contrast of your screen.
5. Press **Save**.

 **Note:** Press **Cancel** at any time to exit this application without making any changes.

Specify Audio Feedback Options

The error beep volume in the phone is related to the volume of the speaker. You can set the beep volume using this procedure; however, adjusting the speaker volume also affects the beep volume.

To adjust the volume of the audio feedback:

1. Press **Applications**  key.
2. Press **Settings**.
3. Press **Audio Feedback**.
4. Set the options using the appropriate actions described below:

| Option | Action |
|------------------------------------|--|
| Turn audio feedback off for errors | Press Turn Off . |
| Adjust audio for error beeps | Press Volume + or Volume – |
| Turn audio feedback on for errors | Press Play Error Tone |

5. Click **Save**.

 **Note:** Press Cancel at any time to exit this application without making any changes.

Specify Text Size

To specify the text size that displays on the phone:

1. Press **Applications**  key.
2. Press **Settings**.
3. Press **Text Size**.
4. Select **Large Text** or **Small Text**.
5. Press **Save**.

Specify Call Notification Behavior

To specify that the *Phone* window automatically displays when you are making or receiving calls:



1. Press **Applications**  key.
2. Press **Settings**.
3. Press **Call Notification**.
4. Press the appropriate options to identify when you want the Phone window to display. For example, if you select the *Made* option, each time the phone goes off hook to make a call, the Phone window is displayed.
5. Press **Save**.

Notes:

- When *To my prime line* is selected, select *Display Call Info* to display Call Information instead of the Phone window.
- Press **Cancel** at any time to exit this application without making any changes.



Adjust the Ringer

To adjust the Ringer Volume while the phone is idle:

1. Press **Superkey** (must be programmed to a key).
2. Press the **No** softkey until "Ringer Adjust?" appears.
3. Press "Ring Adjust".
4. Press **No**.
5. Press "Ringer Vol".
6. Press  (UP) or  (DOWN) .
7. Press **Superkey**.

 **Note:** Adjusting ringer volume also adjusts cordless headset/handset ringer tone.



To adjust the Ringer Volume while the phone is ringing:

- Press  (UP) or  (DOWN).

Notes:

- If the phone is in talk state, this action adjusts the volume of the handset, headset or speaker.
- If the phone is idle, this action adjusts the contrast.

To adjust the Ringer Pitch while the phone is idle:

1. Press **Superkey** (must be programmed to a key).
2. Press the **No** softkey until "Ringer Adjust?" appears.
3. Press "Ring Adjust".
4. Press "Ringer Pitch".
5. Press  (UP) or  (DOWN).
6. Press **Superkey**.

Enable a Screen Saver

You can program your screen saver to turn on after a specific time period of inactivity on your phone.

To enable a screen saver:

1. Press **Applications**  key.
2. Press **Settings**.
3. Press **Screen Saver**.
4. Select the inactivity time.
5. Press the checkbox opposite **Display image** if you wish the screen saver to be displayed.
6. Press **Save**.

Enable PC Connectivity

To enable a connection to be set up between your phone and the UC Express Application:

1. Press **Applications**  key.
2. Press **Settings**.
3. Press **PC Connectivity**.
4. Press the checkbox **Enable**.
5. Press **Save**.

 **Note:** You can use UC Express for easy PC-based programming of the labels on your phone.

For more information on setting up the UC Express Application, see the *Unified Communicator Express User's Guide* on <http://edocs.mitel.com>.

PROGRAMING FEATURES ON YOUR KEYS

Tips on Programming Features

You can program your phone's programmable keys to enable features. To program your keys, use:

- *Settings* application
- Unified Communicator Express application

You can assign the following to a programmable Key:

- Features and Fixed function keys: see [Program Feature Keys Using the Setting Application](#).
- Applications: Settings, Call Forwarding (see [Program Phone Application](#))

 **Note:** Only the System Administrator can program line select and line appearance keys. The user's Prime line by default is Key 1.

Features available for programming on programmable keys

| Feature | Default Label |
|---------------------------|---------------|
| Speed Call | Speed Call |
| Music | Music |
| Night Answer | Night Ans |
| Account Code Verified | Acct Verified |
| Account Code Non-Verified | Acct Non-Ver |
| Hot Desking | Hot Desk |
| Phonebook | Phonebook |
| Speak@Ease™ | Speak@Ease |
| Auto Answer | Auto Ans |
| Paging | Paging |
| Call Pickup | Call Pickup |
| Call Back | Call Back |
| Headset | Headset |
| Make Busy | Make Busy |
| Campon | Campon |
| Override | Override |
| Direct Page | Page |
| Do Not Disturb | DND |
| Single Flash | Flash |
| Double Flash | Dbl Flash |

| Feature | Default Label |
|---------------------------|---------------|
| Meet Me Answer | Meet Me |
| Message Waiting Indicator | Msg Waiting |
| Emergency Call | Emergency |
| Tag Call | Tag Call |
| Privacy Release | Privacy Rls |
| Swap | Swap |
| Release | Release |
| Call History | Call Hist |
| Call Park | Call Park |
| Call Park Retrieve | Park Retrieve |
| Group Listen | Grp Listen |
| Superkey | Superkey |
| Redial | Redial |
| Speaker | Speaker |
| Message | Message |
| Hold | Hold |
| Transfer/Conference | Trans/Conf |
| Cancel | Cancel |
| Analog Line | Analog Line |

Applications available for programming on programmable keys

| Application | Default Label |
|-------------------|---------------|
| Applications List | Applications |
| Call History | Call Hist |
| Call Forwarding | Forwarding |
| Help | Help |
| Settings | Settings |
| Call Info | Call Info |

Program Feature Keys Using the Settings Application

To program a Phone Feature or hard key:

1. Press **Applications**  key.
2. Press **Settings**.
3. Press **Programmable Keys**.
4. Press the key you wish to program.
5. If applications are displayed, press **View Features**.
6. Use the **Page Navigation** keys to move through the features list.
7. Select the desired feature or fixed function key from the list. A default label is automatically assigned to the key.
8. Enter the required information in the fields provided, if necessary.
9. If you are programming any feature other than Speed Call, Message Waiting Indicator, Call Park and Call Park Retrieve, press **Save** and you are finished with this procedure. If you are programming Message Waiting Indicator and or Call Park, perform the following steps:
 - Press the **Edit Number** field.
 - Using the dial pad, enter the appropriate numbers that correspond to the phone whose messages you wish to be notified of (Message Waiting) or the directory number (Call Park).
 - Press **Save**.
 - Press **Close**.

To program a *Phone Application*:

1. Press **Applications**  key.
2. Press **Settings**.
3. Press **Programmable Keys**.
4. Press the key you wish to program.
5. If Features are displayed, press **View Applications**.
6. Select the desired application.
7. Press **Save**.
8. Press **Close**.

To program Speed Call:

1. Press **Applications**  key.
2. Press **Settings**.
3. Press **Programmable Keys**.
4. Press the key you wish to program. If it's already programmed, press **Clear Key**.
5. Press **Speed Call**.
6. Press **Edit Label** and enter the label for the Speed Call.
7. Press **Save**.
8. Press **Edit Number** and enter the phone number for the Speed Call:
 - The maximum length is 26 characters.
 - 0-9, # and *. Pause and Flash are not allowed.
 - You can use dial pad to enter the number.
9. Press **Save**, and then press **Save** again.
10. Press **Close**, and then press **Close** again.

 **Notes:**

- To return to the Feature or Applications list at any time, press **Cancel** or **View Applications**.
- You can also choose to Edit the Label, Clear Information, and Clear Key.

Clear Programming from a Key

You may wish to clear the programming from a key if you are no longer using it.

To clear the feature or application programming from a key:

1. Press **Applications**  key.
2. Press **Settings**.
3. Press **Programmable Keys**.
4. Press the key you wish to clear.
5. Press **Clear Key**.
6. Press **Close**.

MAKING AND ANSWERING CALLS

You can make a call using one of the following methods:

- Press the programmed key associated with the party you want to call. For more information about programming keys, see PROGRAMING FEATURES ON YOUR KEYS.
- Dial the number using the dialpad.
- Use Phone Book (see Phone Book below).

Phone Book

To use Phone Book:

 **Note:** You can enter the first or last name, or both.

1. Press Phone Book (if available) or the key programmed as Phone Book.
2. Enter the name of the desired party, as follows:
 - For each letter in the name, press the appropriate key on the keypad until the letter is shown in the display. For example, if the letter C is required, press the digit 2 three times.
 - Use the <— softkey to correct errors.
 - If the next letter in the name is on the same digit key as the previous letter, press the —> softkey before proceeding.
 - If required, press —> softkey to add a space between the first and last name.
3. Press the **Lookup** softkey.
 - If the system option “Phonebook Lookup – Default to User Location” is enabled for your phone, the search is limited to names that share your location; otherwise, the entire directory is searched.
 - If the system option “Phonebook Lookup – Display User Location” is enabled, after the phonebook search function displays the matching name and directory number, the user’s location is displayed. The display alternates between the name/number and the location every 2 seconds.
4. If no match exists, edit the original entry.
or
If the system option “Phonebook with Location” is enabled, press Backup. ALL LOCATIONS? Is displayed. Press Yes to search the entire directory or press No to search for only names that share your location. Edit the name and press Lookup.
5. If more than one match is found, press the Next softkey.
6. Do one of the following:
 - To make the call, press the Call softkey.
 - To edit the entry, press the Backup softkey.
 - To exit, press Cancel or Superkey (if programmed).



Answer a Call

Do one of the following:

- Select the programmable line key for the ringing line that is flashing.
- Lift the handset or press  (SPEAKER).

End a Call

Do one of the following:

- Press Hang Up or Cancel (.
- Replace the handset.
- Press the key that you have programmed as Cancel.
- If you are in Handsfree mode, press  (SPEAKER).

Redial

To redial the last number that you manually dialed:

1. Lift the handset (optional).
2. Press  (REDIAL).

Redial - Saved Number

To save the last number that you manually dialed:

1. Lift the handset.
2. Dial the appropriate feature access code.

To Redial a saved number:

1. Lift the handset.
2. Dial the appropriate feature access code.

Handsfree Operation

To use Handsfree to make a call:

1. If you want to use a Non-Prime Line, press a Line Appearance key.
Note: Your administrator must program Line Appearances to your phone.
2. Dial the number.

3. Begin speaking when the called party answers. Your phone's Handsfree microphone and Handsfree speaker transmit and receive audio.

To use Handsfree operation to answer calls:

1. Press the flashing line key.
2. Begin speaking. Your phone's Handsfree microphone and Handsfree speaker transmit and receive audio.

To hang up while using Handsfree operation:

- Press  (SPEAKER).

To turn Mute on during Handsfree operation:

- Press  (MUTE). The Mute key light turns ON.

To turn Mute off and return to conversation:

- Press  (MUTE). The Mute key light turns OFF.

To disable Handsfree operation:

- Lift the handset.

To return to Handsfree operation:

1. Press  (SPEAKER).
2. Hang up the handset.

Auto-Answer

When the Auto-Answer feature is active, incoming calls ring briefly, and then the phone answers the call in Handsfree mode. You can continue the call handsfree or use the handset.

To enable or disable Auto-Answer:

- Press **Auto-Answer** key. (See [Programming Features on Your Keys](#) for instructions on programming features on your phone.) The key is highlighted and all incoming calls are answered in Handsfree mode.

To switch from Handsfree mode to handset mode:

- Lift the handset

To end a call, do one of the following:

- Press  (Cancel)
- Press the Hang Up softkey.
- Wait for the caller to hang up.

CALL HANDLING

Hold

To place a call on Hold:

1. Press  (HOLD).
2. Press the key that you have programmed as Hold. The indicator flashes on the line that has the held call.

 **Note:** You can only retrieve a call from hold when the phone is idle.

To retrieve a call from Hold, do one of the following:

- Lift the handset and press the flashing line key.
- Press the flashing indicator.
- Use the Add Held feature to conference into the held call.

To retrieve a call from Hold at another phone, do one of the following:

- Press the flashing line key.
- Dial the appropriate feature access code and the number of the station that placed the call on Hold.

Mute

Mute lets you temporarily turn your phone's handset, headset or handsfree microphone off during a call.

To turn Mute on during a call:

- Press  (MUTE). The  (MUTE) light turns ON.

To turn Mute off and return to the conversation:



- Press  (MUTE). The  (MUTE) light turns OFF.

 **Note:** If you are on a Handsfree MUTED call and you lift the handset, the handset microphone is automatically enabled and the MUTE light turns OFF.

 **NOTE FOR USERS ON RESILIENT 3300 ICP SYSTEMS:** If your phone switches to the secondary system while your speaker or handset is muted (that is, while the Mute key is lit) the call remains muted until you hang up.

Transfer

To Transfer an active call:



1. Press  (TRANSFER).
2. Dial the number of the third party.
3. Do one of the following:
 - To complete the Transfer, hang up.
 - To announce the Transfer, wait for an answer, consult, and hang up.
 - To cancel the Transfer, press  (CANCEL).

To transfer an active call during headset operation:

1. Press  (TRANSFER).
2. Dial the number of the third party.
3. To complete the Transfer, press the Release feature key.

Conference

To form a Conference when a two-party call is already in place, or to add another party to an existing Conference:

1. Press  (TRANSFER).
2. Dial the number of the next party.
3. Wait for an answer.
4. Press  (TRANSFER).

To leave a Conference:

- Hang up or press  (CANCEL).

Conference Split

To Split a Conference and speak privately with the original party:

- Press the **Split** softkey.

Add Held

To move a call on hold to another line appearance:

1. Press an available line key.

2. Press the **AddHeld** softkey.
3. Press the flashing line key.

To add a call on Hold to an existing conversation or conference:

1. Press the **AddHeld** softkey.
2. Press the flashing line key.

Swap

To call another party when you are in an established two-party call:

1. Press  (TRANS/CONF).
2. Dial the number.

To alternate between the two parties:

- Press the **Trade Calls** softkey.

Call Forwarding

Call Forward lets you redirect incoming calls to an alternate number when

- your phone is busy,
- when you're not answering, or
- all the time.

You can program, activate, and deactivate Call Forward Always quickly through the Applications screen while you have other types of Call Forwarding, such as Busy External, activated through your Call Forwarding profiles.

For example, you can enable profiles to forward calls to your voice mailbox when your phone is busy or unanswered. Then, if you must leave your desk, you can quickly enable Call Forward Always to another phone, such as your home phone or cell. After you return to your desk and deactivate Call Forwarding Always, your profiles for busy or unanswered conditions remain active.

USING QUICK CALL FORWARD ALWAYS

To program and enable Call Forward Always:

1. Launch Applications and press **Call Forwarding**
or
Press the **Forwarding** feature key.
2. If a number is already programmed, you can
 - Press **Activate** to enable forwarding to the current number
or

- Enter a new destination number and then press **Activate**.

 **Note:** Call Forward Always takes precedence over all other types of forwarding.

To deactivate Call Forward Always:

1. Launch Applications and press **Call Forwarding**
or
Press the **Forwarding** feature key
2. Press **Deactivate**.

PROGRAMMING CALL FORWARDING USING PROFILES

You can create Call Forward profiles that identify where to send your incoming calls. After you create and save a Call Forward profile in the [Call Forwarding](#) application, you can enable or disable the profile at any time.

Notes:

- The None Profile is a default profile provided by the system. It has no numbers programmed. Use the None Profile to turn off all Call Forwarding.
- The default profile appears when the Call Forwarding set up does not match any of your profiles.
- Only one call profile can be active at a time.
- The dotted radio button icon next to the profile shows the current active profile.

To create a Call Forward profile:

1. Launch Applications and press **Call Forwarding**
or
Press the **Forwarding** feature key.
2. Press **Profiles**.
3. Press **New Profile**.
4. Press **Edit Profile Name**. An on-screen keyboard displays.
5. Press the appropriate keys in the on-screen keyboard to enter the profile name and press **Save**. This profile name identifies where your phone calls will be forwarded to.
6. Select the check box opposite the desired type of Call Forwarding:
 - **Always:** forwards all your phone calls
 - **Busy Internal:** forwards internal phone calls after several rings if your line is busy
 - **Busy External:** forwards external phone calls after several rings if your line is busy
 - **No Answer Int:** forwards internal phone calls redirects your calls after several rings if you don't answer
 - **No Answer Ext:** forwards external phone calls redirects your calls after several rings if you don't answer

7. Press **Edit Number** to display the on-screen keyboard. In the on-screen keyboard, enter the appropriate number.
8. Press **Save**.
9. Press **Enable**.
10. Press **Save**.
11. Repeat Step 6 to Step 10 for each Call Forwarding type that you wish to program.
12. Press **Save**. This profile is saved but it is not activated. To activate this profile, see *Activate Call Forward* below.
13. Press **Close**.
14. Press **Close**.

 **Note:** Press Cancel at any time to exit this application without making any changes.

ACTIVATE CALL FORWARD

To turn Call Forward on once it has been programmed:

1. Press the **Applications**  key.
2. Press **Call Forwarding**.
3. Press **Profiles**.
4. Press the appropriate Profile setting.
5. Press **Activate**.
6. Press **Close**.

CANCEL CALL FORWARD

To cancel Call Forward:

1. Press the **Applications**  key.
2. Press **Call Forwarding**.
3. Press **Profiles**.
4. Press **None** setting.
5. Press **Activate**.
6. Press **Close**.

USING OTHER FEATURES

Certain features require access to a Superkey menu; therefore, a Superkey must be programmed to a key to access this menu. See PROGRAMING FEATURES ON YOUR KEYS for information on how to program a Superkey.

Account Codes

An account code is a series of digits that you assign to your calls, usually for accounting purposes. The code identifies the account in the call records that your system generates. A forced account code is usually entered from another extension, enabling you to use features or make calls that the extension otherwise could not. If you want this feature enabled on your phone, ask your System Administrator.

To use Account Codes:

1. Lift the handset.
2. Dial the Account Code digits.
3. Press #.

To enter an Account Code during a call:

1. Press **Superkey** (must be programmed to a key).
2. Select **Account Code**.
3. Dial the Account Code digits.
4. Press the **Save** softkey.
5. Do one of the following:
 - For a verified account code, press the **Yes** key.
 - For a non-verified account code, press the **No** key.

ACD

If your phone is ACD-enabled, you can log in as an agent. When there is no agent logged onto an ACD-enabled set, *LOGGED OUT* is displayed.

To log in as an ACD agent:

1. Press **Superkey**.
2. Press **Yes**.
3. Enter your Agent ID, using the key pad.
4. Press **Enter**.
The text, LOGGED OUT disappears.

Attendant Call Hold - Remote Retrieve

To retrieve a call placed on Hold by the attendant:

1. Lift the handset.
2. Dial the appropriate feature access code.
3. Dial the digits announced by the attendant.

Callback

The Callback feature allows you to be notified when a busy phone becomes free or when a phone has been used after a no-answer condition was encountered.

To request a Callback when you reach a busy or unanswered station:

1. Press **Call Me Back**.
2. Hang up.

When the party is available, your phone starts ringing, and the display shows the Callback ringing indicator.

To answer a Callback:

- When you see the Callback ringing indicator, lift the handset.

Call Forward - Remote (I'm Here)

To forward calls from a remote station to your current location:

1. Press **Superkey** (must be programmed to a key).
2. Press the **No** softkey until "Call Forwarding?" appears.
3. Press the **Forwarding** softkey.
4. Press the **Next** softkey until "I Am Here" appears.
5. Press the **To Me** softkey.
6. Dial the extension of the remote station.
If you make an error while dialing, use the <— softkey to backspace and correct the number.
7. Press  (**DOWN**) or the **Save** softkey.

To cancel Call Forward – Remote from the station that set the remote forwarding:

1. Lift the handset.
2. Dial the appropriate feature access code.
3. Dial the extension of the remote station.

4. Hang up.

To cancel Call Forward – Remote from the station that was forwarded:

1. Press **Superkey** (must be programmed to a key).
2. Press the **No** softkey until "Call Forwarding?" appears.
3. Press the **Forwarding** softkey.
4. Press the **Review** softkey.
5. Press the **Change Key** softkey.
6. Press the **Turn FWD Off** softkey.
7. Press **Superkey** (must be programmed to a key).

Call Forward - End Chaining

To ensure that calls do not get forwarded again by the destination number:

1. Lift the handset.
2. Dial 64.
3. Hang up.

To again allow calls to be forwarded by the destination number:

1. Lift the handset.
2. Dial the appropriate feature access code.
3. Hang up.

Call Forward - Forced

To force an incoming call to be forwarded:

- Press the **Forward** softkey.

Call Forward - Override

To override Call Forward and ring a station:

1. Lift the handset.
2. Dial the appropriate feature access code.
3. Dial the extension number.

Call Park

The Call Park feature allows you to place a call in a special hold state. You, or someone else, can then retrieve the call from any extension in the system.

After parking the call, the system can automatically connect you to paging equipment so that you can announce the call to the requested party.

To park an active call:

1. Do one of the following:
 - Press the **Call Park** feature key (must be programmed)
 - Press  (TRANS/CONF), and then dial the appropriate feature access code. The display shows PARKED@, followed by the park destination and parking spot index (if applicable). Example: PARKED@ 1234 @ 02.
2. Dial the directory number on which to park the call (not required if the number is programmed to the **Call Park** feature key).
3. To inform a user that a parked call is waiting, do one of the following:
 - If automatic paging is enabled, announce the call and the park retrieve digits shown on the display.
 - If automatic paging is disabled, press the programmed **Page** key, or dial the appropriate feature access code, followed by the Paging zone number (if required). Then, announce the call and park retrieve digits shown on the display.

 **Note:** Paging over a loudspeaker is not permitted in handsfree mode; you must use the handset or headset.

To retrieve a parked call:

1. Do one of the following:
 - Dial the appropriate feature access code.
 - Press the **Call Park - Retrieve** feature key (must be programmed).
2. Dial the directory number on which the call is parked (not required if the number is programmed to the **Call Park** feature key).
3. If there are multiple calls parked on the number, dial the two-digit index number to retrieve a specific call, or # to retrieve the longest parked call.

Call Pickup

To answer a call that is ringing at another extension in your Pickup Group:

1. Lift the handset.
2. Press the key that you programmed as **Pickup**.

To answer a call that is ringing at another extension not in your Pickup Group:

1. Lift the handset.
2. Dial the appropriate feature access code.
3. Dial the number of the ringing station.

Campon

When you get a busy tone, you can use the Campon feature to be notified when the busy party becomes available.

To Campon to a busy station:

- Press the **I Will Wait** softkey.

To retrieve a call when you hear the Campon tone:

- You can use the Trade Call or Call Swap feature with the  (TRANS/CONF) hardkey or a programmable line key.

Direct Paging

Direct Paging allows you to page a party through their handsfree speaker. If the paged party has Off-Hook Voice Announce enabled, the page will be heard even when the party is on a handset or headset call. If the paged party has Handsfree Answerback enabled and turned on the phone, your page automatically establishes a handsfree call with the paged party.

To page a party:

1. Lift the handset.
2. Press the Direct Paging feature key or dial the appropriate feature access code.
3. Dial the directory number.
4. Speak to the dialed party after the tone.

How you answer a Direct Page depends on whether Handsfree Answerback is enabled and turned on at your phone. See one of the following procedures in this guide:

- Direct Paging - Handsfree Answerback Enabled
- Direct Paging - Handsfree Answerback Disabled

Direct Paging - Handsfree Answerback Enabled

When you receive a Direct Page, Handsfree Answerback automatically establishes a Handsfree call on your phone after a single burst of tone.



Your administrator enables or disables Handsfree Answerback on your phone. After your administrator enables Handsfree Answerback, you can choose to turn it on or off directly from your phone.

To turn Handsfree Answerback on:

- When your phone is idle, press  (**MUTE**) once. The MUTE key light flashes to indicate that Handsfree Answerback is ON.
- When a Direct Page arrives, the MUTE key light turns OFF and a Handsfree call is automatically established.

To turn Handsfree Answerback off:

- Press the flashing  (**MUTE**) key once. The MUTE key light turns OFF.
- To respond to a Direct Page when Handsfree Answerback is OFF, see "Direct Page - Handsfree Answerback Disabled" elsewhere in this guide.

 **Note:** By default, Handsfree Answerback is turned OFF at your phone. If the  (**MUTE**) key is OFF when your set is idle, Handsfree Answerback is OFF.

To answer a call using Handsfree Answerback:

| Phone state before Page arrives | To answer the Direct Page |
|--|--|
| Phone is idle and MUTE is flashing | <ol style="list-style-type: none"> 1. Check that MUTE is OFF. 2. Listen for the paging party. 3. Begin speaking. 4. Lift the handset if you wish to switch from a Handsfree call to a handset call. |
| You are on a handset or headset call, and MUTE is OFF | <ol style="list-style-type: none"> 1. Check that MUTE is flashing. 2. Press MUTE. The light turns ON solid, and you are now speaking to the paging party and have muted your handset/headset call. 3. Speak to the paging party. Press MUTE to alternate between handset/headset and handsfree calls. |
| You are on a MUTED handset/headset call, OR, you are on a Handsfree call | The party paging you receives a busy tone. Handsfree Answerback does not interrupt your call. |

To end a Handsfree Answerback call:

- Press either  (**SPEAKER**) or  (**CANCEL**).

When the Handsfree Direct Page call ends, the MUTE key light returns to the state it was in before the call was established.



Direct Paging - Handsfree Answerback Disabled

Your administrator enables or disables Handsfree Answerback and you can also turn it on or off on your phone. To turn Handsfree Answerback off, see "Direct Paging - Handsfree Answerback Enabled" elsewhere in this guide. When Handsfree Answerback is disabled on your phone and you receive a Direct Page, the Direct Page is indicated by a single burst of tone.

To answer Direct Page calls when Handsfree Answerback is disabled:

| Phone state before Page arrives: | To answer the Direct Page (indicated by single burst of tone): |
|--|---|
| Phone is idle and MUTE is OFF. | <ol style="list-style-type: none"> 1. Check that MUTE is ON solid. 2. Lift the handset OR press the MUTE key to answer in Handsfree mode. (The light turns OFF.) 3. Begin speaking. |
| You are on a handset call or headset call, and MUTE is OFF | <ol style="list-style-type: none"> 1. Check that MUTE is flashing. 2. Press MUTE. The light turns ON solid and you are now speaking to the paging party and have MUTED your handset/headset call. 3. Speak to the paging party. Press MUTE to alternate between handset and handsfree calls. |
| You are on a MUTED handset/headset call, OR, you are on a Handsfree call | The party paging you receives a busy tone. Handsfree Answerback does not interrupt your call. |

To end a Direct Page call, do one of the following:

- Hang up the handset to end a handset call.
- Press  (**SPEAKER**) to end a Handsfree call.
- Press  (**CANCEL**).

When the Handsfree Direct Page call ends, the (MUTE) key light returns to the state it was in before the call was established.

Direct Voice Call

Direct Voice Call feature allows you to establish a two-way handsfree call at another extension whether or not it has Handsfree Answerback or Auto-Answer turned on. Only extensions programmed by the system administrator to receive Direct Voice Calls can be called using this feature.

To make a Direct Voice Call:

1. Lift handset.
2. Dial the appropriate feature access code.
3. Dial the extension you want.
4. Speak to called party.

Do Not Disturb

When you enable Do Not Disturb, callers will get a busy tone, and an on-screen text message indicating that you do not wish to be disturbed.

To activate or deactivate Do Not Disturb:

- Press the **Do Not Disturb** key that you programmed. The key is highlighted when Do Not Disturb is activated and is not highlighted when Do Not Disturb is not activated. The phone status line shows the Do Not Disturb  icon.

To activate Do Not Disturb from a remote extension:

1. Lift handset.
2. Dial the number of the station to which **Do Not Disturb** is to apply.
3. Hang up.

To deactivate Do Not Disturb from a remote station:

1. Lift handset.
2. Dial the appropriate feature access code.
3. Dial the number of the station with **Do Not Disturb** activated.
4. Hang up.

Emergency Calls

Warning for emergency number dialing: Consult your local authorities for Emergency Numbers and 911 or equivalent service availability in your area.

There are two methods of dialing emergency numbers, based on the programming of your 3300 ICP:

- Emergency Call Routing NOT programmed
- Emergency Call Routing programmed

CAUTION: Verify with your System Administrator which type of emergency number dialing you can use.

EMERGENCY CALLS WHEN EMERGENCY CALL ROUTING NOT PROGRAMMED

If **Emergency Call Routing is NOT programmed**, Emergency Number dialing should **only be performed by picking up the handset and selecting the Analog Line key you have programmed**. Emergency dialing using an IP connection may not be supported due to ICP system configuration and country location. For more information, contact your System Administrator.

EMERGENCY CALLS WHEN EMERGENCY CALL ROUTING PROGRAMMED

 **Note:** This procedure is in addition to the methods described above.

To make an Emergency Call if Emergency Call Routing is programmed:

1. Lift the handset.
2. Dial your Local Emergency Number (911 or equivalent).

Group Listen

With Group Listen, you can carry on a conversation using the handset or headset while allowing others nearby to listen to the person at the far end over the handsfree speaker. The handsfree microphone is disabled in Group Listen mode.

To activate Group Listen while in a handset conversation:

- Press the Group Listen key.
Audio from the far-end party is now heard through both the handset/headset and the speaker.

To make the call a normal two-way speaker call:

- Press  (SPEAKER).

To exit Group Listen mode (and return to a normal handset/headset call):

- Press the **Group Listen** key.

To activate or deactivate Group Listen while in headset mode:

- Press the **Group Listen** key.

Group Paging / Meet Me Answer

Group Paging allows you to page a group of telephones through their built-in speakers. You can belong to as many as three paging groups with one group designated as your "prime" group.

When you need to respond to a Group Page but don't know the identity or directory number of the paging party, use the Meet Me Answer feature. You have up to 15 minutes after receiving the page to use Meet Me Answer.

To make a Group Page:

1. Lift the handset.
2. Press **Direct Page** or dial the appropriate feature access code.
3. Do one of the following:
 - To page your prime page group, press #.
 - To page a specific page group, dial the page group directory number.

4. Speak to the dialed party after the tone.

To respond to a Group Page by using Meet Me Answer:

1. Lift handset.
2. Press the key you have programmed to Meet Me Answer or dial the appropriate feature access code.
(See Programming Features on Your Phone for instructions on programming features to your phone.)
3. Do one of the following:
 - To respond to a page from your prime page group, press #.
 - To respond to a page from a specific page group, dial the page group directory number.

Group Presence

Group Presence allows members of call groups (Hunt, ACD, Ring, and Personal Ring) to make themselves absent or present in a group. Only members who are present in a group are offered calls to that group.

If you are in a Personal Ring group (see Handoff – Personal Ring Groups), Group Presence lets you choose which device in the group you want to use to receive calls by making it 'Present' and the others 'Absent.'

You can also change the presence status of other users if allowed by your system administrator.

Users belonging to multiple groups can control their presence in each group separately through the use of feature keys (one for each group), or by dialing a feature access code (FAC) followed by the group number. For information about programming feature keys, see page 17.

To join a group:

1. Lift the handset.
2. Do one of the following:
 - Press the **Group Presence** feature key to join the group associated with the key.
 - Dial the Group Presence - Join Group feature access code followed by the group directory number.

The LED associated with the key is steady lit when the member is present and off when absent.

To leave a group:

1. Lift the handset.
2. Do one of the following:
 - Press the **Group Presence** feature key to join the group associated with the key.

- Dial the Group Presence - Leave Group feature access code followed by the group directory number.

The LED associated with the key is steady lit when the member is present and off when absent.

To change another group member's presence status:

1. Lift the handset.
2. Dial the Group Presence - Join Group Third Party or Group Presence - Leave Group Third Party .
3. Dial the directory number of the group member.
4. Dial the group directory number.

To change the presence status of another Personal Ring Group member using a feature key:

- Press the **Personal Ring Group Presence** feature key.

The LED associated with the key is steady lit when the member is present and off when absent.

Handoff - Personal Ring Groups

Personal Ring Groups (PRGs) associate two or more of your devices, such as your office phone and cell phone, with a single user Directory Number (DN). PRGs are set up by the system administrator. Group member devices ring simultaneously when called.

You can use the group Handoff feature to “Push” or “Pull” calls between group member devices. A Push passes the call to the group, where it can be answered by any other present group device. A Pull takes an in-progress call away from another member.

To use Handoff to Push an in-progress call to the PRG:

- Press the **Handoff** key.

To Pull an in-progress call from another member of the PRG:

- Lift the handset (optional if the device supports hands free operation).
- Press the **Handoff** key.

Headset Operation

To enable Headset Operation:

- Press the **Headset** feature key.

To answer a call (when Auto Answer is disabled):

- Press the flashing line key or Float Key.

To answer call (when Call Notification is enabled)

- Select **Close** and then select the prime line.

To hang up:

- Press  (**CANCEL**).

To mute your headset microphone:

- Press the  (**MUTE**) key. The light turns ON.

To turn mute off and return to the conversation:

- Press the  (**MUTE**) key. The light turns OFF.

Hot Desking

Hot Desking allows you to log into the telephone system from any phone designated as a Hot Desk phone. When you log in at the phone using your assigned Hot Desk User Directory number, the phone assumes all your speed dials, features keys, call forwarding setup, and line appearances - even your language preference for the display. Any changes you make to the phone while you are logged in--for example, adding a speed dial--are saved to your personal profile. Logging in activates your profile on any phone that supports Hot Desking.

When you log in as a hot desk user, Call History data is updated for you. You do not see any call logs for the phones registered DN; you only see your history data. When you log out, the registered DN's history data is displayed. To access your voice mail when you are logged in as a hot desk user, you must log in to your voice mail.

To log into a Hot Desking phone (the phone must be idle):

1. Press the key you have programmed to HotDesking.
2. Press the **Login** key.
3. Using the phone keys, enter your Hot Desk User Directory number, and then press **OK**.
4. Enter your pin number and press **OK**.
While logged in as a hot desk user, the phone status line shows the Hot Desk  icon.

To log out of Hot Desking phone (the phone must be idle):

1. Press the key you have programmed to HotDesking.
2. Press the **Logout** command key.
3. Press the **Confirm** command key.

 **Note:** Your profile can only be active on one phone at a time. If you log in from another phone without logging out from the first one, the system will automatically deactivate your profile on the first phone.

Hot Desk Remote Logout

A user who has forgotten to log out of a Hot Desking phone can be logged out from a phone that is configured to allow Hot Desk Remote Logout.

 **Note:** This feature must be allowed by your System Administrator via the Class of Service.

To remotely log out a Hot Desking phone:

1. Dial 111.
2. Dial the Hot Desk User Directory number that you want to log out.
3. Press the **Logout** command key.
4. Press the **Confirm** command key.

Hot Desk - PIN Change

To change your Hot Desk PIN:

1. Log into a Hot Desking phone.
2. Press **Superkey** (must be programmed to a key).
3. Press the **HotDesk PIN** softkey.
4. Press the **Yes** softkey.
5. Enter the current PIN or skip to step 6 if a PIN has not yet been assigned.
6. Press the **Enter** softkey.
7. Enter the new PIN.
The PIN can include digits from 0 to 9 only and can be from 0 to 8 characters in length.
8. Press the **Enter** softkey.
9. Re-enter the new PIN.
10. Press **Superkey**.

Make Busy

You can use the Make Busy feature to have your phone appear busy to other callers. If callers dial your phone number when Make Busy is enabled a message indicating that your line is busy is displayed on their phones.

To enable Make Busy:

- Press the key you programmed to **Make Busy**. The key illuminates when Make Busy is activated and *MAKE BUSY* is displayed.

To disable Make Busy:

- Press the key you programmed to **Make Busy**.

Message Waiting Indicator

The Message Waiting Indicator (MWI) feature allows you to be notified when messages have been left on another phone. Once you have programmed a key to MWI, this key is always enabled.

To use MWI to contact the extension that left a message:

- Press the key you have programmed to MWI.

Messaging - Advisory

Advisory Messaging enables you to select a notice that appears on your phone display to inform people visiting your desk of your whereabouts. Select from a variety of advisory messages, including "On vacation", "In a meeting", or "Out to Lunch".

To turn Messaging - Advisory on:

1. Press **Superkey** (must be programmed to a key).
2. If necessary, press the **No** softkey until "Advisory Msgs" appears.
3. Press the **Advisory** softkey.
4. Press the **Next** softkey until the desired message appears.
5. Press the **Turn Msg On** softkey.

To turn Messaging - Advisory off:



1. Press **Superkey** (must be programmed to a key).
2. If necessary, press the **No** softkey until "Advisory Msgs" appears. .
3. Press the **Yes** softkey when "Advisory appears.
4. Press the **Turn Msg Off** softkey .

Messaging - Callback

To leave a Callback Message when you hear busy or ringback tone:

- Press  (**MESSAGE**) or press the Callback softkey.

To respond to a message waiting condition on your phone:

1. Press  (**MESSAGE**).
2. If a password is required, dial your password (and press the **Enter** softkey if available).
3. Press the **Read Message** softkey, and do one or all of the following:
 - To display the time the message was sent, press the **More Msg** softkey.
 - To display the number of the caller, press the **More Msg** softkey twice.
 - To call the message sender, press the **Call** softkey.
 - To delete the message, press the **Erase Msg** softkey.
 - To view the next message, press  (**MESSAGE**).

You can check for messages from a remote station:

1. Press **Superkey** (must be programmed to a key).
2. Press the **No** softkey until "Remote Msging?" appears.
3. Press the **Yes** softkey.

4. Dial your directory number.
5. Press the **Enter** softkey.
6. If a password is required, enter your password and press the Enter softkey.
7. Press the **Yes** softkey.

You can set, change, or clear a password (up to 7 digits, not including 0):

1. Press **Superkey** (must be programmed to a key).
2. Press the **No** softkey until "Set Password?" appears.
3. Press the **Yes** softkey.
4. Do one of the following:
 - To enter a new password, enter your password.
 - To change or clear your password, enter your current password.
5. Press the **Enter** softkey.
6. To change or clear your password, do one of the following:
 - To change your password, enter your new password and press the Enter softkey.
 - To clear your password, enter 0.
7. Enter your new password again.
8. If you are setting up or changing a password, press the **Enter** softkey.
9. Press **Superkey** (must be programmed to a key).

Messaging - Cancel Callback

To cancel a Callback:

1. Lift the handset.
2. Dial the appropriate feature access code.
3. Dial the number of the called station.
4. Hang up.

Messaging - Cancel All Callbacks

To cancel all Callbacks:

1. Lift the handset.
2. Dial the appropriate feature access code.
3. Hang up.

Music

To turn Music on and off when the phone is idle, do one of the following:

- To turn the music on, press the key that you programmed to Music or the Music softkey.
- To turn the music off, press the key that you programmed to Music or the Music softkey.

When the Music is activated, the key you have programmed is highlighted.

Night Answer

The Night Answer feature allows you to route calls to an attendant or message at night.

To enable Night Answer:

- Press the key you programmed to Night Answer. When you have enabled Night Answer, this key is highlighted.

To disable Night Answer:

- Press the key you programmed to Night Answer

Override (Intrude)

When you dial a number whose owner has enabled Make Busy, your phone displays the message indicating that the line is busy. You have the option to override this setting.

To use Override when you encounter a busy tone:

1. Press the key you programmed as Override.
2. Wait for an answer.

Paging

To use Paging:

1. Lift handset.
2. Press the key that you have programmed to Page.
3. Dial the Paging zone number (if required).
4. Make the announcement.

Phone Lock

Phone Lock prevents access to the features on a phone, with the following exceptions:

- unlocking the set via a user PIN
- Hot Desk Login and Logout support, and
- Emergency Call Notification support.

Phone Lock has no effect on incoming calls but restricts outgoing calls, with the following exceptions:

- calls to emergency trunk routes, and
- local operators.

Most keys on the device are disabled, except for the dial pad and volume keys. The following access and keys are disabled:

- Superkey access
- Applications access
- Softkeys
- feature access keys
- feature access codes, and
- account codes

 **Note:** Softkeys will be displayed but disabled, except the hot desking softkeys will remain enabled. The Phone Lock, Hot Desk login, and Emergency Notification feature access keys will still be available. Superkey will provide Emergency Notification, if it is pending.

Before locking a set, ensure that:

- the set is in the idle state (there should not be any ongoing call)
- you do not have any calls on hold or on consultation-hold on any line appearance
- you are not in headset mode

To activate Phone Lock:

- Press the **Phone Lock** feature key or enter the Phone Lock Feature Access code.

To de-activate Phone Lock:

- Press the **Phone Lock** feature key or enter the Phone Unlock Feature Access code.
- Enter your user PIN to unlock the set.

 **Note:** If a user PIN has not been assigned, enter # when prompted for the PIN to unlock the phone.

User PIN

A Personal Identification Number (PIN) allows a user to log into a set as a hot desk user or generic SIP user. It is also used to de-activate the Phone Lock feature. PINs must be from 0 to 8 digits in length. Only digits (0 to 9) are permitted. The default PIN is blank (length zero).

Users will have one generic PIN that can be used for any required features.

The User PIN initially has a zero length, allowing a user, for example, to unlock a phone using a blank PIN for Phone Lock. Setting the User PIN on the set requires the PIN to have at least one digit.

To change the User PIN:

1. Press **SuperKey** (must be programmed to a key)
2. Press **No** until "Set User PIN?" appears.
3. Press **Yes** softkey or the **User PIN** softkey.
4. At the prompt "Enter Old PIN", enter your old User PIN.
5. Press **Enter**.
6. At the prompt "Enter new PIN", enter your new PIN.
Use left arrow key to correct mistakes. The PIN can include digits from 0 to 9 only and can be from 0 to 8 characters in length.
7. Press **Enter**.
8. At the prompt to verify the PIN, re-enter your new PIN again. The set confirms successful or failed completion.
9. Press **Superkey** to end the Superkey session.

Record-a-Call

This feature uses your voice mail system to record your telephone conversations.

 **Note:** You may be required by law to inform the other party that you are recording the conversation. For specific instructions, consult your system administrator.

To start recording while on a 2-party call:

- Press the **Record Call** key. (See *Feature Keys* elsewhere in this guide for instructions on programming a Record Call key to your phone.)

 **Note:** Your system may be programmed to automatically begin recording external calls when you or the other party answers.

To control recording, do one or all of the following:

- To pause recording, press the **Pause** softkey.
- To resume recording after pausing, press the **Resume** softkey.
- To stop a recording without saving it, press the **Erase** softkey or  (CANCEL).
- To stop and save a recording, press the **Save** softkey.

Putting the call on hold saves the recording; taking the call off hold starts a new recording. Depending on system programming, hanging up, or pressing  (TRANS/CONF) or a DSS key, may also save the recording.

To listen to a recording:

1. Lift the handset.
2. Access your voice mailbox.
3. Follow the prompts to retrieve the recording.

Speak@Ease

Users of the Speak@Ease softkey can place a call by speaking the name of the person they wish to dial. Speak@Ease enables you to have access to Mitel Speech Server. The Speech Server is a speech recognition application that routes incoming calls to a specific destination based on spoken commands.

To dial a call using Speak@Ease:

1. Press the key you have programmed to Speak@Ease.
2. Speak the name of the person you wish to call.

Speed Call

Speed Call is an application that allows you to dial a specific number with one key press. You must program Speed Call on a Programmable key. For more information on programming this key, see [Program Feature Keys Using the Settings Application](#).

To make a Speed Call:

- Press the key that you have programmed as your Speed Call key.
-

Tag Call

Tag Call allows you to signal that you are the victim of a threatening or malicious call. Using the tag, your system administrator or Telephone Company can identify the source of the call and provide this information to appropriate personnel or authorities.

CAUTION: Tagging a non-malicious call may result in fines or other penalties.

To tag a malicious call:

1. Press the programmed Tag Call key while the call is in progress. For information on how to program keys, see to Programming Features On Your Keys

-OR-

Press  (TRANS/CONF).

2. Dial the appropriate feature access code.
If the call was successfully tagged, *Thank You* is shown on the display; otherwise, *Not Allowed* is displayed.

 **Note:** Tag Call can be used on active two-party calls only. Calls on hold and conference calls cannot be tagged.

Timed Reminder

To program a Timed Reminder:

1. Press **Superkey** (must be programmed to a key).
2. Press the **No** softkey until "Timed Reminder" appears.
3. Press the **Reminder** softkey.
4. Enter the time in 24-hour format.
5. Press the **Save** softkey.

To view, change, and/or cancel a pending Reminder:

1. Press **Superkey** (must be programmed to a key).
2. Press the **No** softkey until "Timed Reminder" appears.
3. Press the **Reminder** softkey.
4. Do one of the following:
 - To change the Reminder, press the **Change Key** softkey, enter the new time, and press the **Save** softkey.
 - To cancel the Reminder, press the **Cancel No.** softkey.
 - To exit without canceling the Reminder, press **Superkey** (must be programmed to a key).

To acknowledge a Timed Reminder when your phone rings once:

- Press the **Confirm** softkey.

Trunk Flash

The Trunk Flash feature allows you to access Centrex features (if available) while you are talking on an outside call.

To flash a trunk while talking on an outside call:

1. Press the key you have programmed to Flash.
Note: You can program a key to single flash or double flash.
2. Wait for dial tone.
3. Dial the Centrex feature access code.

| Global Headquarters | U.S. | EMEA | CALA | Asia Pacific |
|-----------------------|-----------------------|------------------------|-----------------------|-------------------------|
| Tel: +1(613) 592-2122 | Tel: +1(480) 961-9000 | Tel: +44(0)1291-430000 | Tel: +1(613) 592-2122 | Tel: +61(0) 2 9023 9500 |
| Fax: +1(613) 592-4784 | Fax: +1(480) 961-1370 | Fax: +44(0)1291-430400 | Fax: +1(613) 592-7825 | Fax: +61(0) 2 9023 9501 |

For more information on our worldwide office locations, visit our website at www.mitel.com/offices

THIS DOCUMENT IS PROVIDED TO YOU FOR INFORMATIONAL PURPOSES ONLY. The information furnished in this document, believed by Mitel to be accurate as of the date of its publication, is subject to change without notice. Mitel assumes no responsibility for any errors or omissions in this document and shall have no obligation to you as a result of having made this document available to you or based upon the information it contains.

M MITEL (design) is a registered trademark of Mitel Networks Corporation. All other products and services are the registered trademarks of their respective holders.
© Copyright 2011, Mitel Networks Corporation. All Rights Reserved.

www.mitel.com

