

Module 6

FLOWCHART

What is a Flowchart?

A Flowchart is a diagram that uses graphic symbols to depict the nature and flow of the steps in a process (Viewgraph 1). Another name for this tool is "flow diagram."

When should teams use Flowcharts?

At the beginning of your process improvement efforts, an as-is Flowchart helps your team and others involved in the process to understand how it currently works. The team may find it helpful to compare this as-is Flowchart with a diagram of the way the process is supposed to work. Later, the team will develop a Flowchart of the modified process—again, to record how it actually functions. At some point, your team may want to create an ideal Flowchart to show how you would ultimately like the process to be performed. Among the benefits of using Flowcharts (Viewgraph 2) are that they

- Promote understanding of a process by explaining the steps pictorially. People may have differing ideas about how a process works. A Flowchart can help you gain agreement about the sequence of steps. Flowcharts promote understanding in a way that written procedures cannot do. One good Flowchart can replace pages of words.
- Provide a tool for training employees. Because of the way they visually lay out the sequence of process steps, Flowcharts can be very helpful in training employees to perform the process according to standardized procedures.
- Identify problem areas and opportunities for process improvement. Once you break down the process steps and diagram them, problem areas become more visible. It is easy to spot opportunities for simplifying and refining your process by analyzing decision points, redundant steps, and rework loops.
- Depict customer-supplier relationships, helping the process workers to understand who their customers are, and how they may sometimes act as suppliers and sometimes as customers in relation to other people.

Some practical applications for flowcharting are:

- The steps in troubleshooting a broken turbine
- The process used to fight a class BRAVO fire
- How to clean a berthing compartment
- The process used for getting the ship underway

What Is a Flowchart?

A diagram that uses graphic symbols to depict the nature and flow of the steps in a process.

FLOWCHART

VIEWGRAPH 1

Benefits of Using Flowcharts

- Promote process understanding
- Provide tool for training
- Identify problem areas and improvement opportunities
- Depict customer-supplier relationships

FLOWCHART

VIEWGRAPH 2

What symbols are used in Flowcharts?

The symbols that are commonly used in Flowcharts (Viewgraph 3) have specific meanings and are connected by arrows indicating the flow from one step to another:

- Oval. Ovals indicate both the starting point and the ending point of the process steps.
- Box. A box represents an individual step or activity in the process.
- Diamond. A diamond shows a decision point, such as yes/no or go/no-go. Each path emerging from the diamond must be labeled with one of the possible answers.
- Circle. A circle indicates that a particular step is connected to another page or part of the Flowchart. A letter placed in the circle clarifies the continuation.
- Triangle. A triangle shows where an in-process measurement occurs.

What are the levels of Flowchart detail?

When you are developing a Flowchart, consider how it will be used and the amount and kind of information needed by the people who will use it. This will help you determine the level of detail to include. Viewgraph 4 compares the levels described below using the process for producing the Plan of the Day (POD).

Macro level. The top leadership may not need the amount of detail required by the workers in a process. A "big picture," or macro-level, view of the process may be enough for their purposes. Generally, a macro-level Flowchart has fewer than six steps. Think of it as a view of the ground from an airplane flying at 30,000 feet.

Mini level. The term "mini" or "midi" is used for a Flowchart that falls between the big picture of the macro level and the fine detail of the micro level. Typically, it focuses on only a part of the macro-level Flowchart. Using the airplane analogy, you see the level of detail as if looking at the ground from 10,000 feet.

Micro level. People trying to improve the way a job is done need a detailed depiction of process steps. The micro-level, or ground-level, view provides a very detailed picture of a specific portion of the process by documenting every action and decision. It is commonly used to chart how a particular task is performed.

Symbols Used in Flowcharts

Start / End



Process Step



Decision

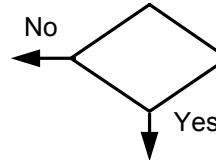

Connector

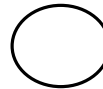

Measurement



FLOWCHART

VIEWGRAPH 3

Levels of Flowcharts

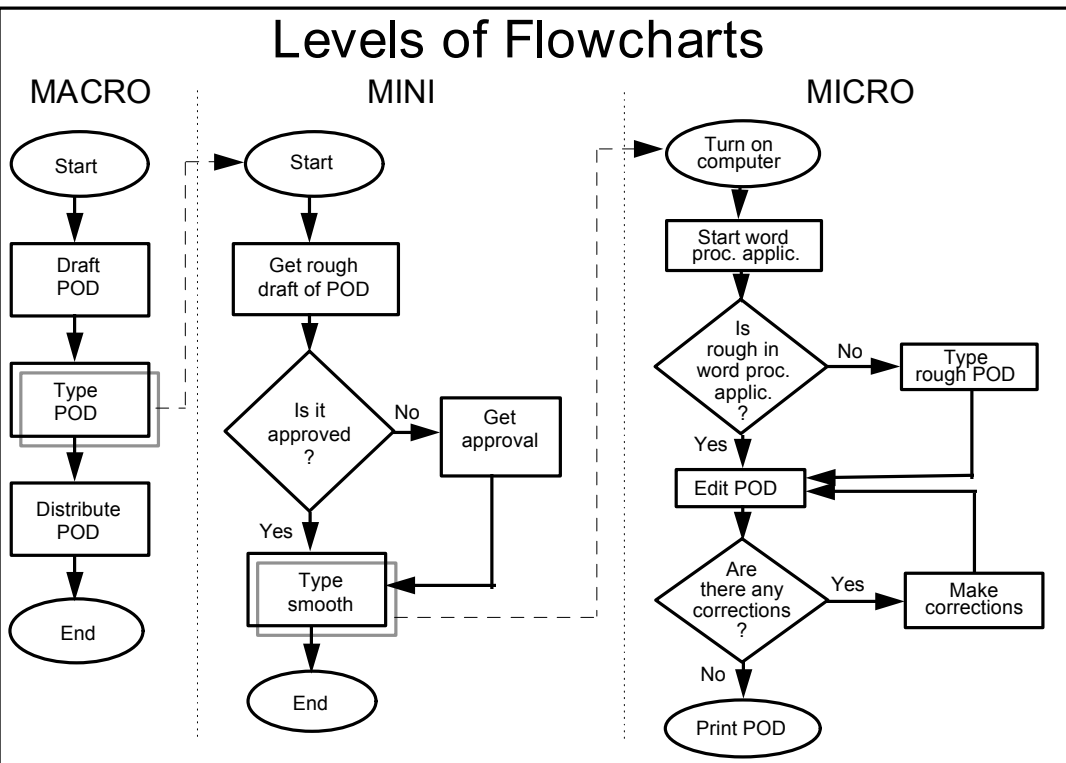

FLOWCHART

VIEWGRAPH 4

The label used is not important. What matters is that the people constructing a Flowchart understand how the information is going to be used and the people interpreting the chart understand the level of detail it presents.

How do we get started?

Many methods for constructing Flowcharts have been described and you can safely use any one of them, as long as you start out by doing these things:

- Identify the right people to develop the chart.
- Determine what you expect to get from the Flowchart.
- Identify who will use it and how.
- Define the level of detail you need.
- Establish the boundaries of the process to be improved.

A word about boundaries. These are the starting and ending points for your Flowchart. For example, process boundaries for a repair shop overhauling a pump might be when the pump enters the shop and when it passes final testing. The boundaries determine the number of activities to be studied and the number of people involved in the process, functionally and cross-functionally.

At first, many teams struggle with the Flowchart tool. Team members may be unsure about process boundaries or disagree on the level of detail needed. The first few drawings quickly become a tangled mess of lines as steps are added, moved, and reconnected. And most discouraging of all, workers may question the value of the Flowchart and fail to use it in their daily work.

What are the keys to successful flowcharting?

Many of these difficulties can be avoided or overcome by applying the keys to success outlined in Viewgraph 5. It is vital that you start by depicting the process the way it really works, not the way you think it should work. You need to chart the process as it is. Later you can chart it as it is supposed to work (by regulation), or as you would like it to work (your ideal picture of the process). Here are the keys:

- Start with the big picture. It is best to draw a macro-level Flowchart first. After you've depicted this big picture of the process, you can develop other diagrams with increased levels of detail.
- Observe the current process. A good way to start Flowcharting a process is to walk through the current process, observing it in actual operation.

Keys to Success

- Start with the big picture
- Observe the current process
- Record process steps
- Arrange the sequence of steps
- Draw the Flowchart

FLOWCHART

VIEWGRAPH 5

- Record the process steps you observed. Record the steps as they actually occur in the process as it is. Write the steps on index cards or post-it™ notes. You can use a different color to represent each individual or group involved if that will help you to understand and depict the flow more accurately.
- Arrange the sequence of steps. Now arrange the cards or post-it™ notes exactly as you observed the steps. Using cards lets you rearrange the steps without erasing and redrawing and prevents ideas from being discarded simply because it's too much work to redraw the diagram.
- Draw the Flowchart. Depict the process exactly as you observed, recorded, and arranged the sequence of steps.

What are the types of Flowcharts?

Besides the three levels of detail used to categorize Flowcharts, there are three main types of Flowcharts—Linear, Deployment, and Opportunity. The level of detail can be depicted as macro, mini, or micro for each of these types.

The viewgraphs that accompany the explanation below show how one process, Producing the Plan of the Day (POD), might be depicted using each of the three Flowchart types.

- Linear Flowchart. A Linear Flowchart (Viewgraph 6) is a diagram that displays the sequence of work steps that make up a process.

This tool can help identify rework and redundant or unnecessary steps within a process.

- Deployment Flowchart. A Deployment Flowchart [Ref. 5] shows the actual process flow and identifies the people or groups involved at each step (Viewgraph 7). Horizontal lines define customer-supplier relationships.

This type of chart shows where the people or groups fit into the process sequence, and how they relate to one another throughout the process.

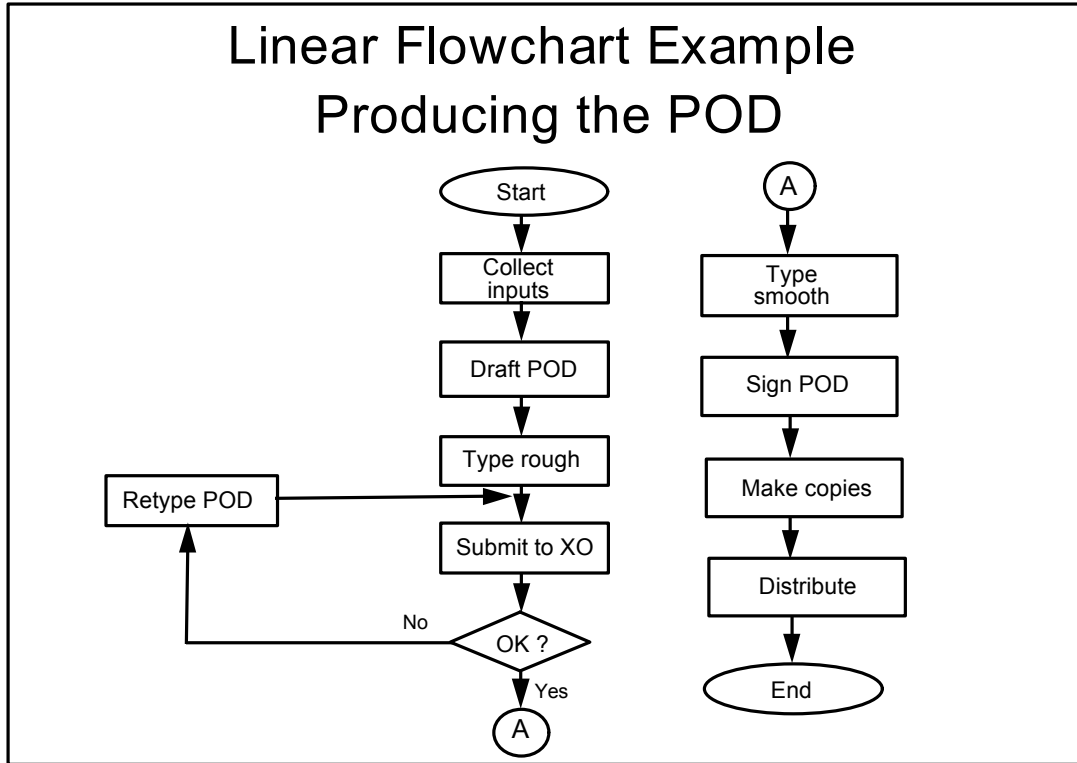

FLOWCHART

VIEWGRAPH 6

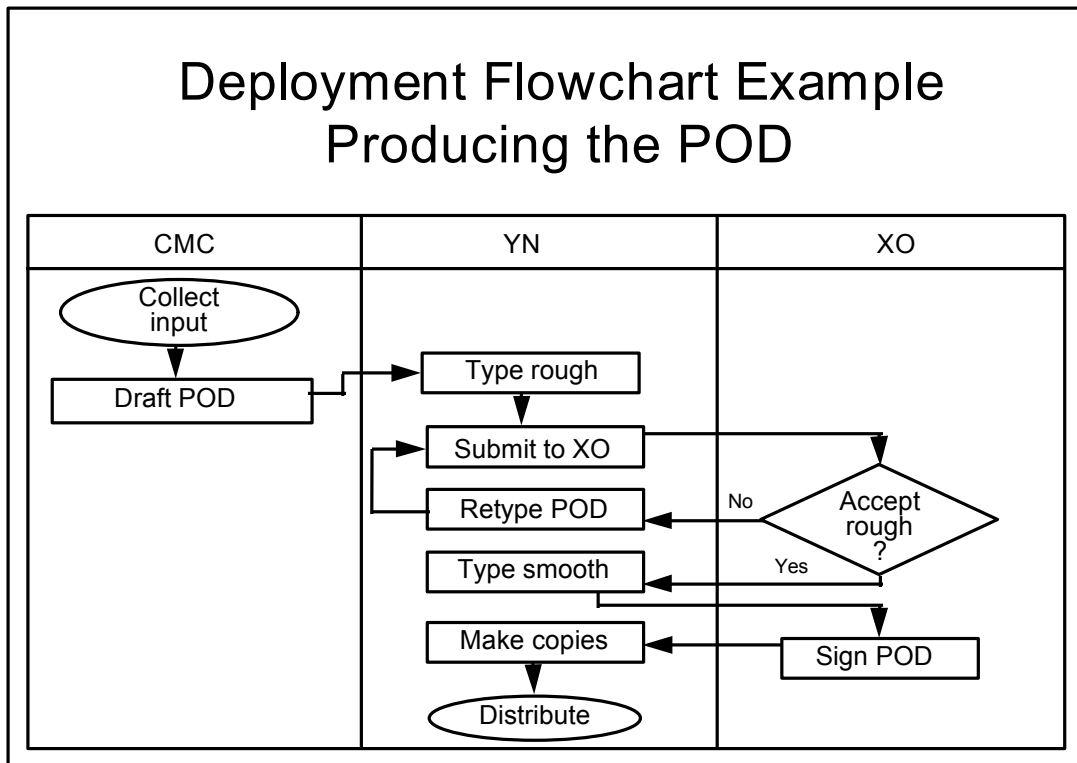

FLOWCHART

VIEWGRAPH 7

- Opportunity Flowchart. An Opportunity Flowchart [Ref. 4]—a variation of the basic linear type—differentiates process activities that add value from those that add cost only (Viewgraph 8).
 - > Value-added steps (VA) are essential for producing the required product or service. In other words, the output cannot be produced without them.
 - > Cost-added-only steps (CAO) are not essential for producing the required product or service. They may be added to a process in anticipation of something that might go wrong, or because of something that has gone wrong. For example, end-of-process inspection might be instituted because of defects, errors, or omissions that occurred in the past. Other CAO steps may depend on actions in supplier processes—waiting for approvals or the availability of equipment, for example.

Now let's look at the steps for constructing the three different kinds of Flowcharts.

How do we construct a Linear Flowchart?

Following are the seven steps for developing a Linear Flowchart (Viewgraph 9).

- Define the process to be flowcharted, and the purpose for flowcharting it.
- Assemble the right people to develop the Flowchart—those operators, technicians, or office workers who are actually involved in the process.
- Establish process boundaries—the starting and ending points.
 - > Identify the major activities or subprocesses that are included in the process.
 - > Determine what is not included in the scope of the process to remove any doubt or confusion about the boundaries. This may also help establish the scope of related processes.
- List the steps, activities, and decisions to be charted. If your team is not sure about a step, mark it to be investigated later.
- Put the steps in chronological sequence. Sometimes it's easier to start with the last step and work back to the first step.
- Assign Flowchart symbols such as boxes, diamonds, and triangles.
- Review and title the Flowchart.

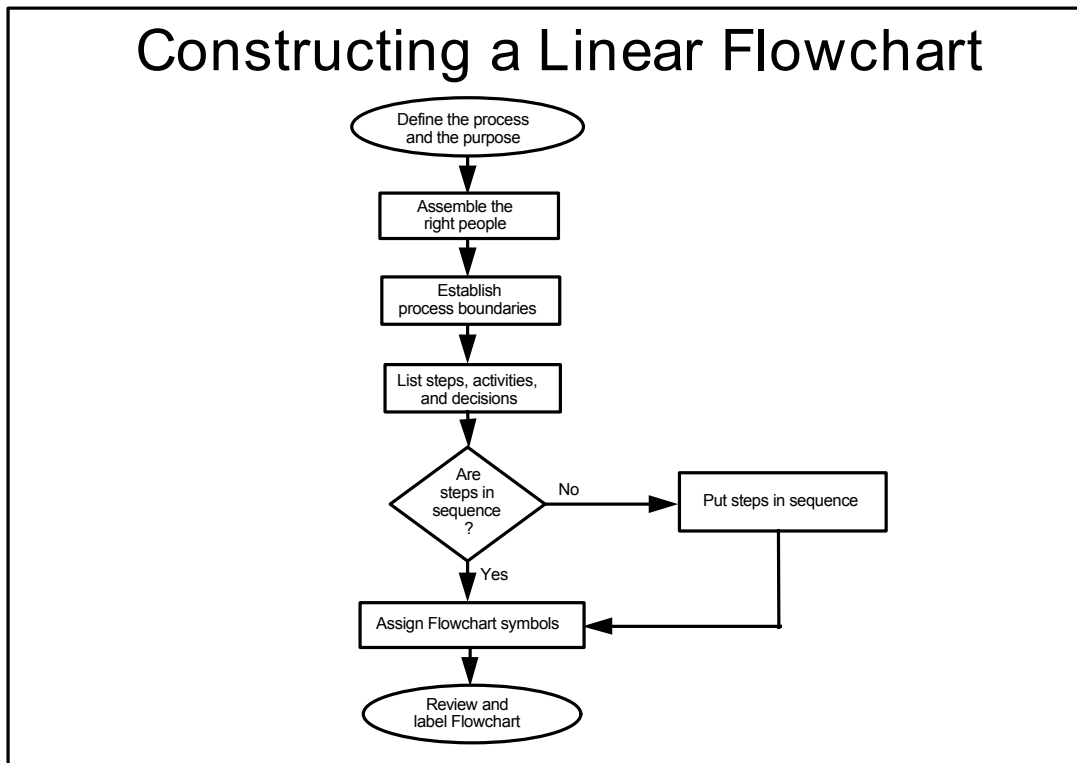
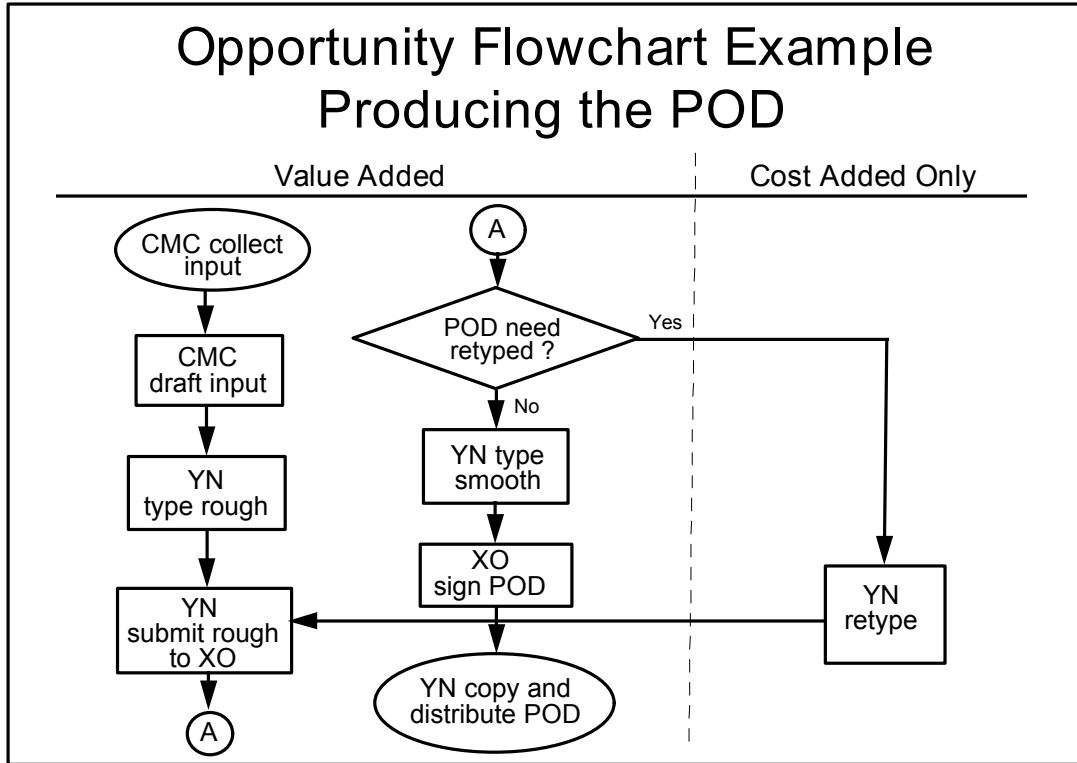

How do we construct a Deployment Flowchart?

To develop a Deployment Flowchart (Viewgraph 10), follow the basic steps for constructing a Linear Flowchart, but modify them as follows:

- List the major steps of the process vertically on the left side of a sheet of paper.
- List the responsible process workers across the top, each in a separate column.
- Place each step in the appropriate column under the responsible process worker's name.
- Connect the steps in the order in which they relate to each other.

NOTE: Every horizontal line in a Deployment Flowchart identifies a customer-supplier relationship.

How do we construct an Opportunity Flowchart?

To construct an Opportunity Flowchart (Viewgraph 11), you need to distinguish value-added from cost-added-only steps. You may want to review how to differentiate these steps under the description of Opportunity Flowcharts that precedes this discussion.

Starting with your Linear Flowchart, evaluate each step before placing it in the Opportunity format.

- Divide your paper into two columns headed Value Added (VA) and Cost Added Only (CAO).
- List the steps in the process in these columns vertically, all VA steps in one column and all CAO steps in the other.
- Connect the steps.

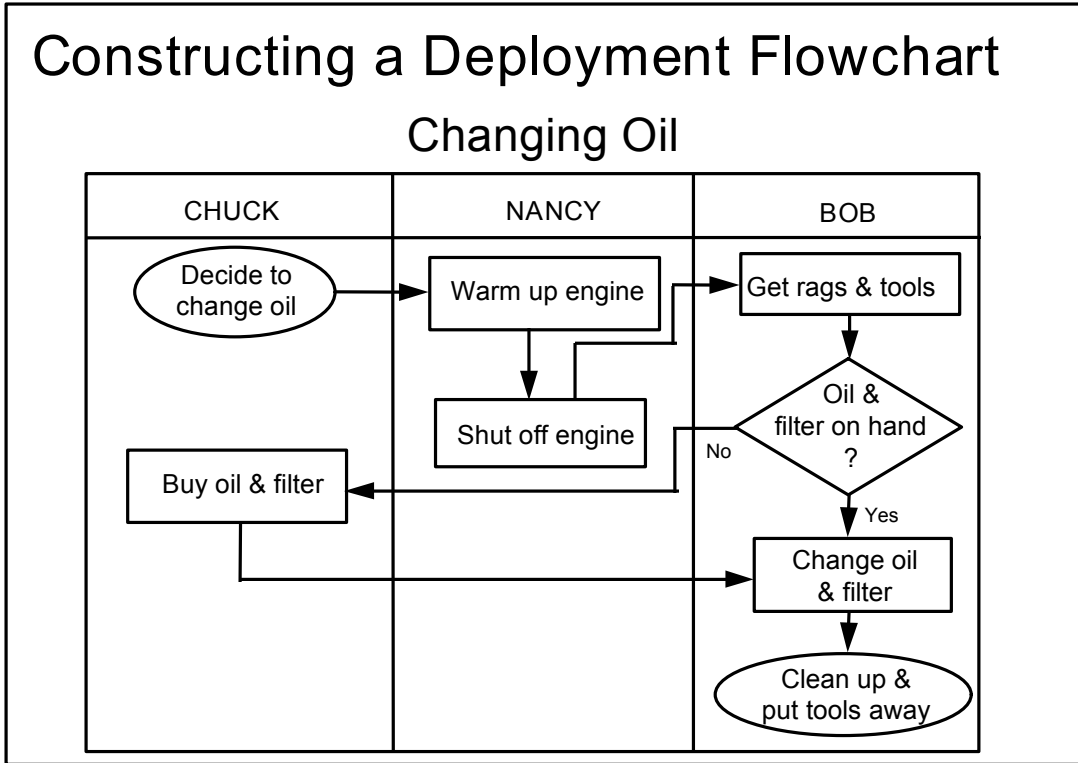

FLOWCHART

VIEWGRAPH 10

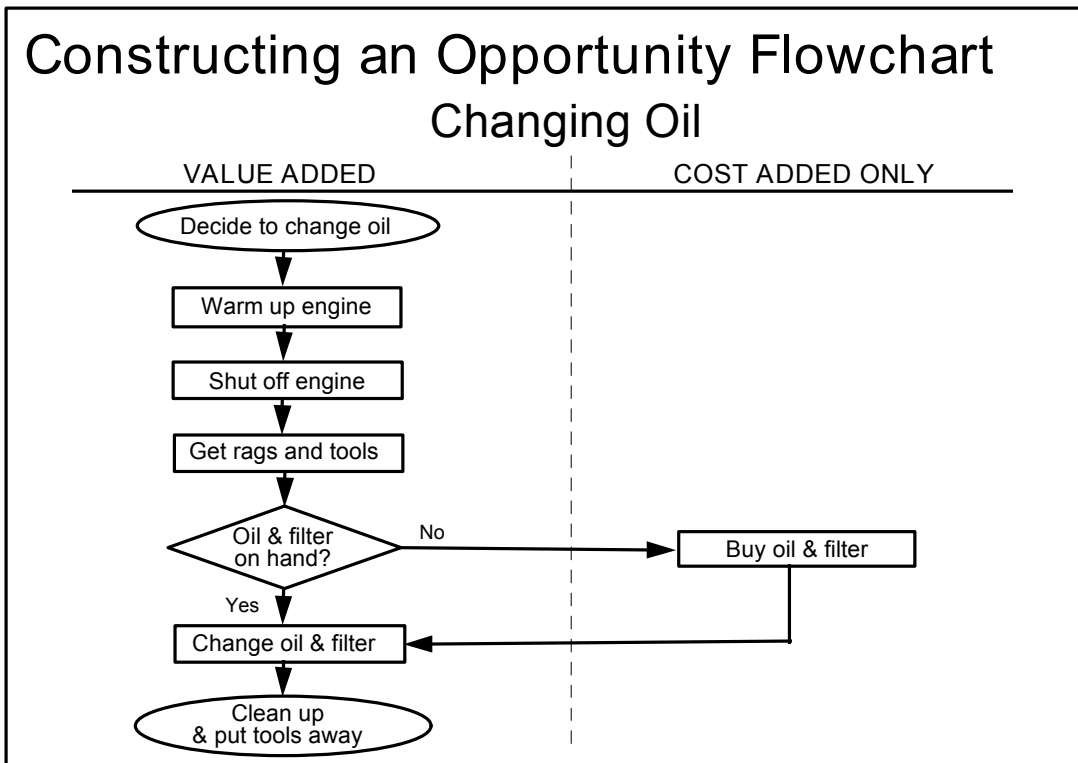

FLOWCHART

VIEWGRAPH 11

How do we interpret our Flowcharts?

A Flowchart will help you understand your process and uncover ways to improve it only if you use it to analyze what is happening. Interpreting your Flowchart will help you to (Viewgraph 12)

- Determine who is involved in the process.
- Form theories about root causes.
- Identify ways to streamline the process.
- Determine how to implement changes to the process.
- Locate cost-added-only steps.
- Provide training on how the process works or should work.

Below is a sequence of steps that will help you through an orderly analysis of your Flowchart (Viewgraph 13).

Step 1 - Examine each process step for the following conditions that indicate a need to improve the process:

- **Bottlenecks.** These points in the process where it slows down may be caused by redundant or unnecessary steps, rework, lack of capacity, or other factors. In the Fire Drill Preparation example depicted in Viewgraph 15, the "Monitors go to Logroom to get red hats. . ." step indicates a potential bottleneck. The rework loop identified as connector "B" is one of several in this diagram.
- **Weak links.** These are steps where problems occur because of inadequate training of process workers, equipment that needs to be repaired or replaced, or insufficient technical documentation. "Inform the drill leader and improvise" is one of the weak links depicted in Viewgraph 15.
- **Poorly defined steps.** Steps which are not well-defined may be interpreted and performed in a different way by each person involved, leading to process variation. "Improvise" is a poorly defined step in the weak link cited above.
- **Cost-added-only steps.** Such steps add no value to the output of the process and should be earmarked for elimination. If the Fire Drill Preparation process in Viewgraph 15 were depicted as an Opportunity Flowchart, "Search the boat for red hats" would be one of many cost-added-only steps.

Step 2 - Examine each decision symbol. You may want to collect data on how often there is a "yes" or "no" answer at decision points marked by a diamond-shaped symbol. If most decisions go one way rather than the other, you may be able to remove this decision point.

Interpreting Your Flowchart

- Determine who is involved
- Form theories about root causes
- Identify ways to simplify and refine
- Determine how to implement changes
- Locate cost-added-only steps
- Provide training

FLOWCHART

VIEWGRAPH 12

Interpretation Steps

- Step 1 - Examine each process step
Bottlenecks? Weak links? Poorly defined steps? Cost-added-only steps?
- Step 2 - Examine each decision symbol
Can this step be eliminated?
- Step 3 - Examine each rework loop
Can it be shortened or eliminated?
- Step 4 - Examine each activity symbol
Does the step add value for the end-user?

FLOWCHART

VIEWGRAPH 13

Step 3 - Examine each rework loop. Processes with numerous checks generate rework and waste. Examine the activities preceding the rework loop and identify those that need to be improved. Look for ways to shorten or eliminate the loop.

Step 4 - Examine each activity symbol. Does the step help build a key quality characteristic into the end product? If not, consider eliminating it. (See the Data Collection module for a discussion of key quality characteristics.)

What pitfalls do we need to watch out for?

Throughout this discussion, we have assumed that the Flowchart you are analyzing reflects the way the process actually functions in the work environment. This is often not the case. There are a number of things that can go wrong when you create your Flowchart that may interfere with interpretation and full understanding of the process.

- > Those developing the Flowchart may have drawn it to represent the process as they envision it, not as it is.
- > People may be reluctant to depict the obviously illogical parts of the process for fear they will be called upon to explain why they allowed it to be that way.
- > Rework loops are either not seen or not documented because people assume rework is small and inevitable.
- > People drawing the Flowchart truly do not know how the process works.

You need to avoid these pitfalls when developing your Flowchart and take measures to correct them when they are revealed through Flowchart interpretation.

How can we practice what we've learned?

The following exercises will enable you to practice what you've learned, first by flowcharting a prepared example, then by creating a Flowchart of a familiar process, and finally, by analyzing a Flowchart provided as an example.

EXERCISE 1: Develop a Flowchart of the Cut Grass Process. The facilitator should prepare this exercise by writing each step of the process shown in Viewgraph 14 on a separate post-it™ and then placing the post-its™ randomly on a chartpack. The team will use the post-its™ to develop a Flowchart of the Cut Grass Process. The facilitator should assist the team in determining and depicting the following:

- Starting and ending points of the process
- Sequence of the steps written on the post-its™
- Decision points
- Appropriate symbols and connectors to use

Viewgraph 14 is an example of a possible Flowchart for the Cut Grass Process.

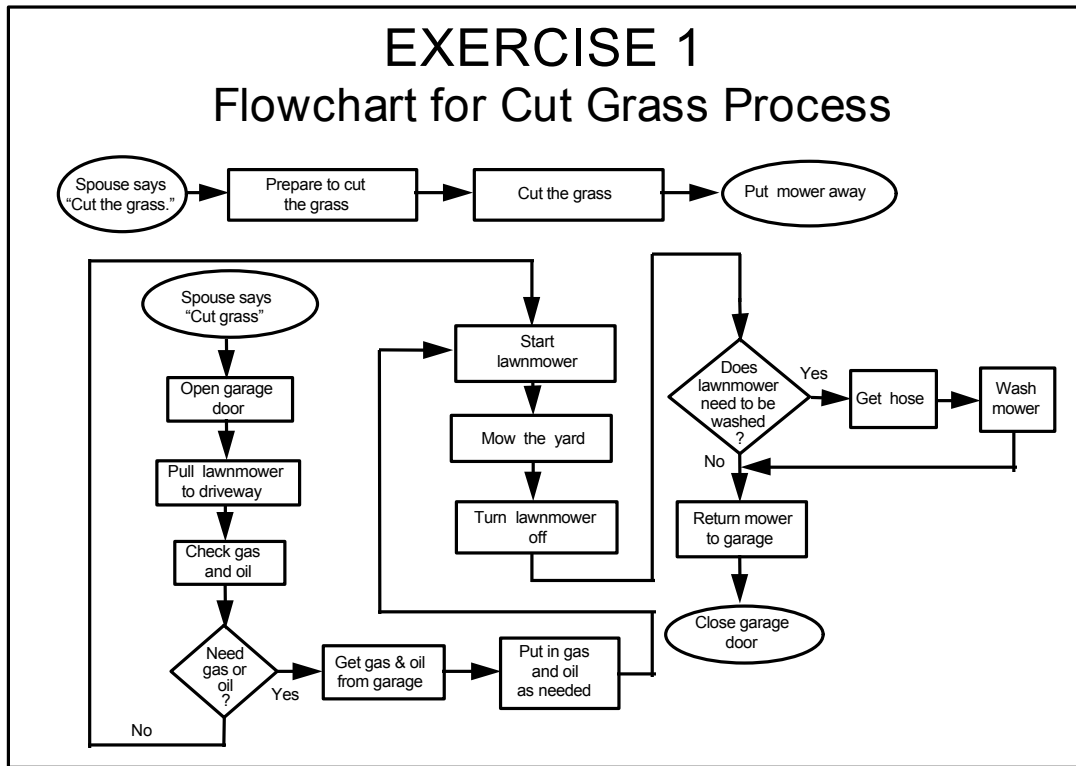

FLOWCHART

VIEWGRAPH 14

EXERCISE 2: Construct a Macro-Level Linear Flowchart. In this exercise, the team will first select a process to be flowcharted from suggestions made by team members. Then, using a chartpack, the facilitator will help them work through the process of constructing a macro-level Flowchart of the selected process. The following questions will help the team through a logical Flowchart development process:

Step 1 - What process will we flowchart? Select a process to flowchart from participant suggestions.

Step 2 - What do we do first? Define the purpose of the Flowchart.

Step 3 - Who should be involved? Discuss who should be on the team that develops the Flowchart.

Step 4 - What are the process boundaries? Establish the starting and ending points of the process.

Step 5 - What are the process steps? List the steps.

Step 6 - What is the sequence of steps? Determine the order in which process activities occur.

Step 7 - What symbols should we use and how do we connect them? Assign the appropriate symbols for the steps and connect them with arrows.

EXERCISE 3: Analyze the Fire Drill Preparation Flowchart. The facilitator should give the team members a few minutes to study Viewgraph 15, then guide them through an interpretation of this Flowchart based on the following questions:

- Is the process flow depicted so you can follow it?
- What would you change?
- What level of Flowchart is this?
- What type of Flowchart is this?
- Are the symbols properly used?
- What bottlenecks, weak links, or poorly defined steps are shown?

Some examples of these potential trouble spots were given in Step 1 of the Flowchart interpretation process, but there are others.

- What cost-added-only steps can you identify?

An example of a cost-added-only step was given in Step 1 of the Flowchart interpretation process, but there are others.

- Can you identify places where it would be useful to take data?
- Are there any rework loops that could be shortened or eliminated?
- What steps do you think could be eliminated?

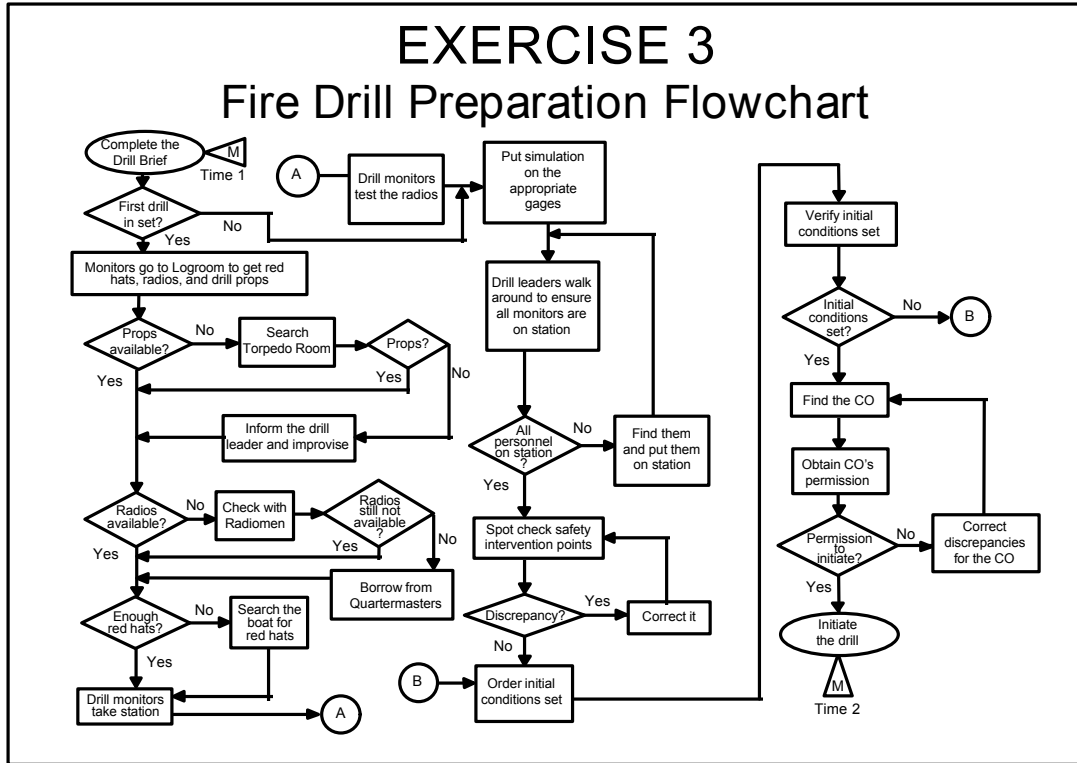

FLOWCHART

VIEWGRAPH 15

REFERENCES:

1. Brassard, M. (1988). The Memory Jogger, A Pocket Guide of Tools for Continuous Improvement, pp. 9 - 13. Methuen, MA: GOAL/QPC.
2. Department of the Navy (November 1992). Fundamentals of Total Quality Leadership (Instructor Guide), pp. 6-12 - 6-19. San Diego, CA: Navy Personnel Research and Development Center.
3. Department of the Navy (September 1993). Systems Approach to Process Improvement (Instructor Guide), pp. 1-60 - 1-63; 5-50 - 5-63. San Diego, CA: OUSN Total Quality Leadership Office and Navy Personnel Research and Development Center.
4. Hacquebord, H. (1990). A Strategy for Helping Managers to Change.
5. Tribus, M. (June 1989). Deployment Flowcharting (workbook and videotapes). Los Angeles, CA: Quality and Productivity, Inc.

What Is a Flowchart?

A diagram that uses graphic symbols to depict the nature and flow of the steps in a process.

Benefits of Using Flowcharts

- Promote process understanding
- Provide tool for training
- Identify problem areas and improvement opportunities
- Depict customer-supplier relationships

Symbols Used in Flowcharts

Start / End

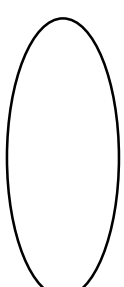

Process Step

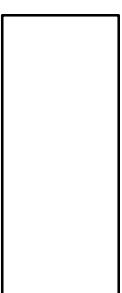

Decision

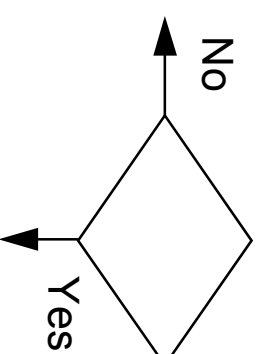

Connector

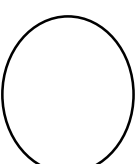

Measurement

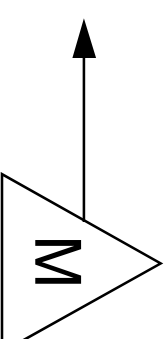

Levels of Flowcharts

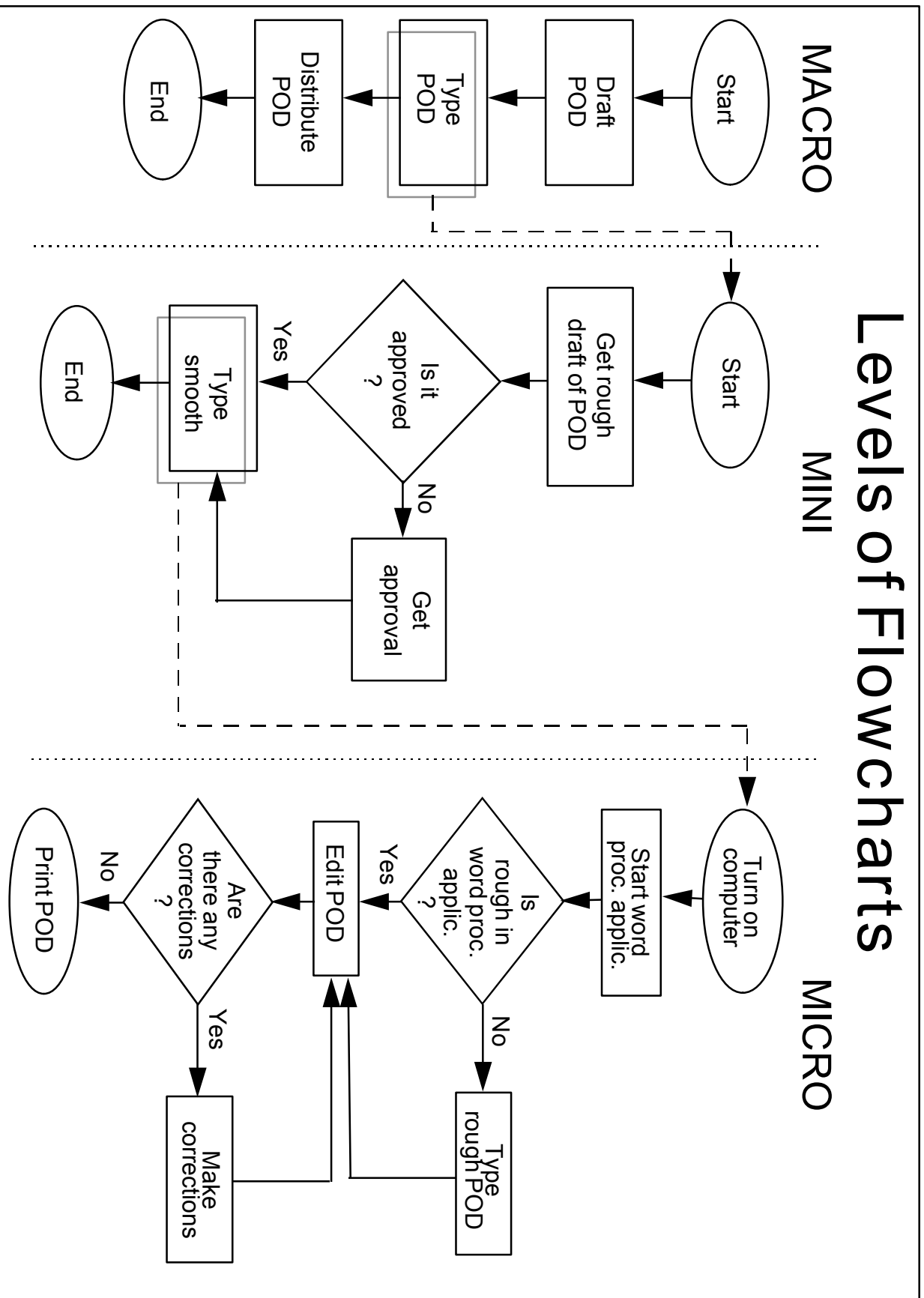

FLOWCHART

VIEWGRAPH 4

Keys to Success

- Start with the big picture
- Observe the current process
- Record process steps
- Arrange the sequence of steps
- Draw the Flowchart

Linear Flowchart Example

Producing the POD

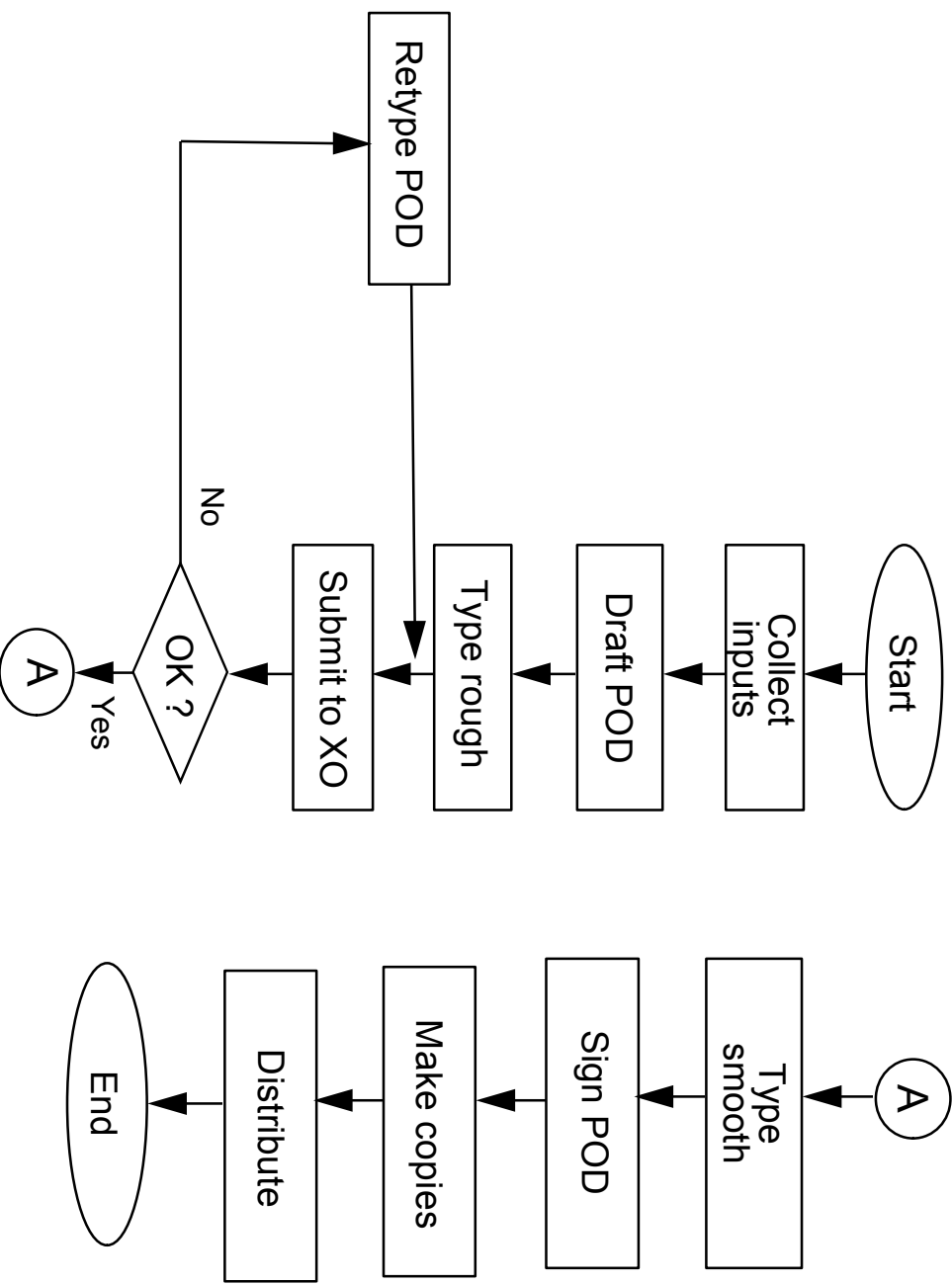

Deployment Flowchart Example

Producing the POD

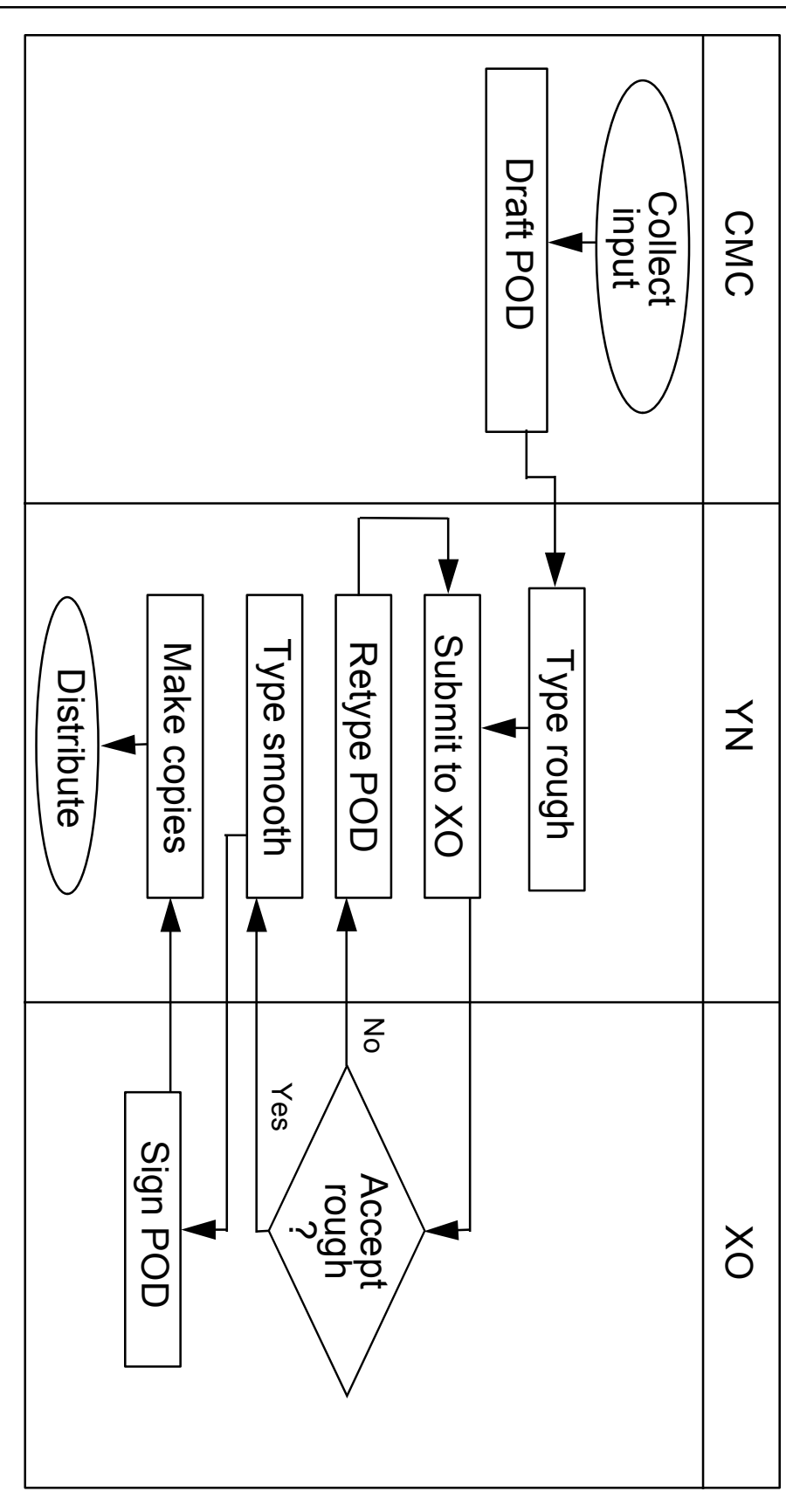

Opportunity Flowchart Example Producing the POD

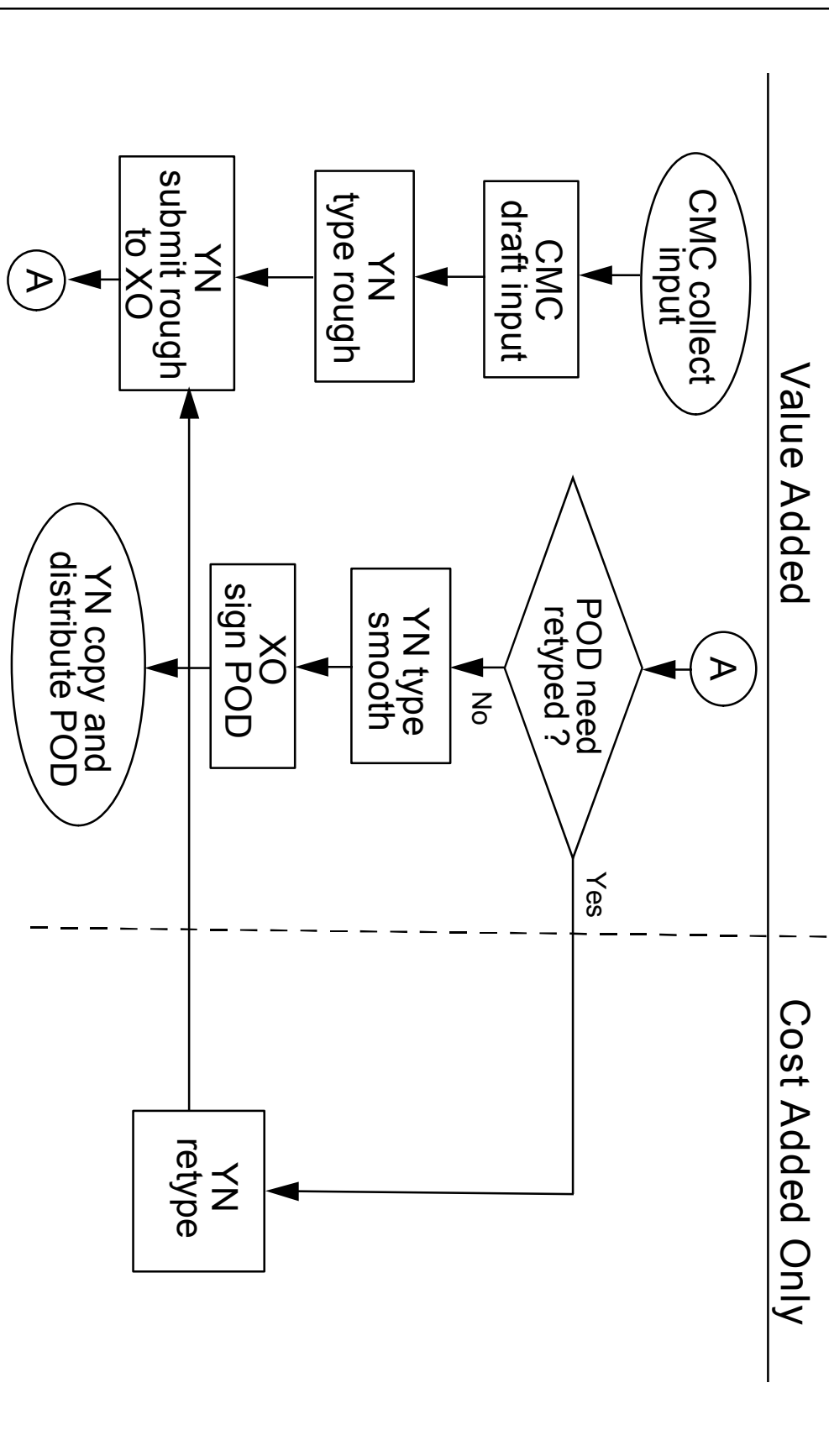

Constructing a Linear Flowchart

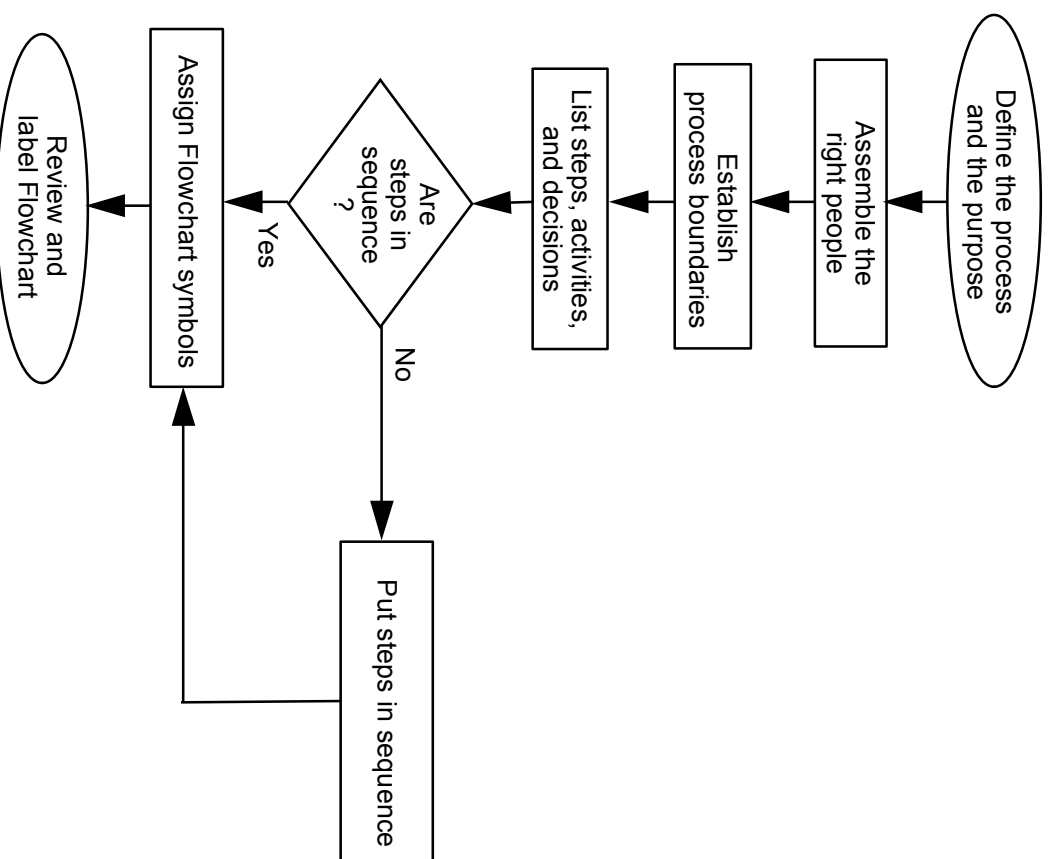

Constructing a Deployment Flowchart

Changing Oil

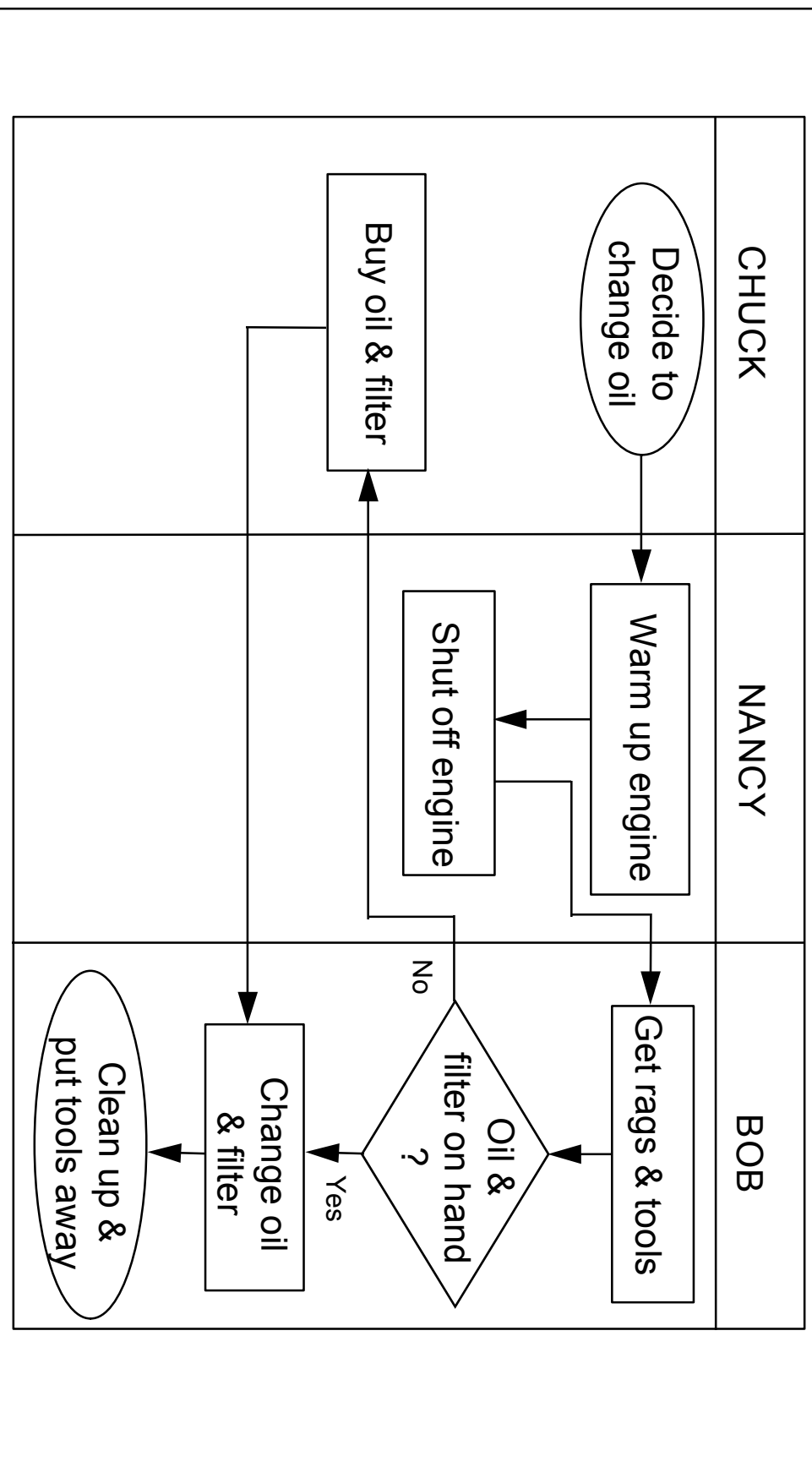

FLOWCHART

VIEWGRAPH 10

Constructing an Opportunity Flowchart

Changing Oil

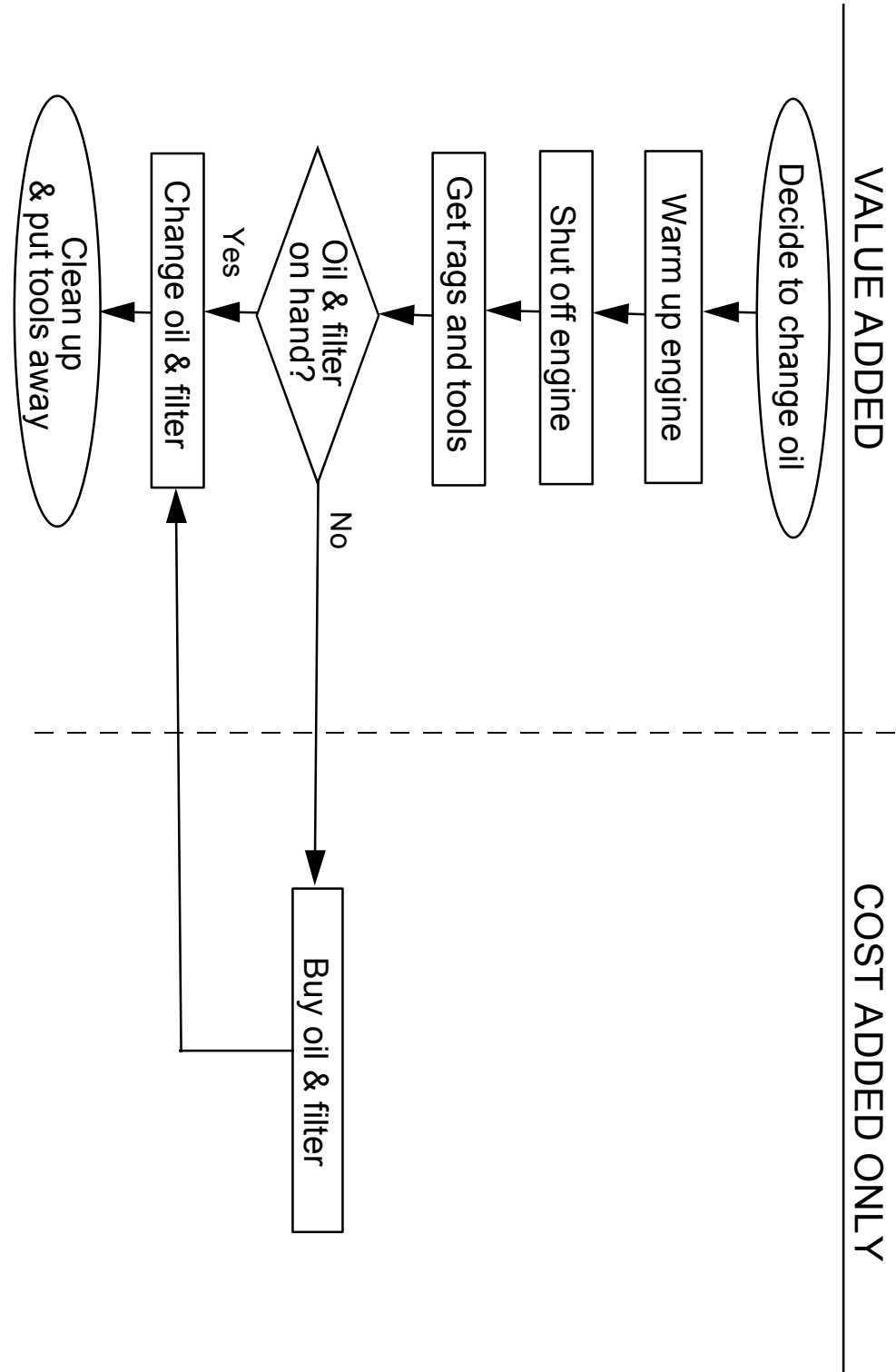

FLOWCHART

VIEWGRAPH 11

Interpreting Your Flowchart

- Determine who is involved
- Form theories about root causes
- Identify ways to simplify and refine
- Determine how to implement changes
- Locate cost-added-only steps
- Provide training

Interpretation Steps

- Step 1 - Examine each process step
Bottlenecks? Weak links? Poorly defined steps? Cost-added-only steps?
- Step 2 - Examine each decision symbol
Can this step be eliminated?
- Step 3 - Examine each rework loop
Can it be shortened or eliminated?
- Step 4 - Examine each activity symbol
Does the step add value for the end-user?

EXERCISE 1

Flowchart for Cut Grass Process

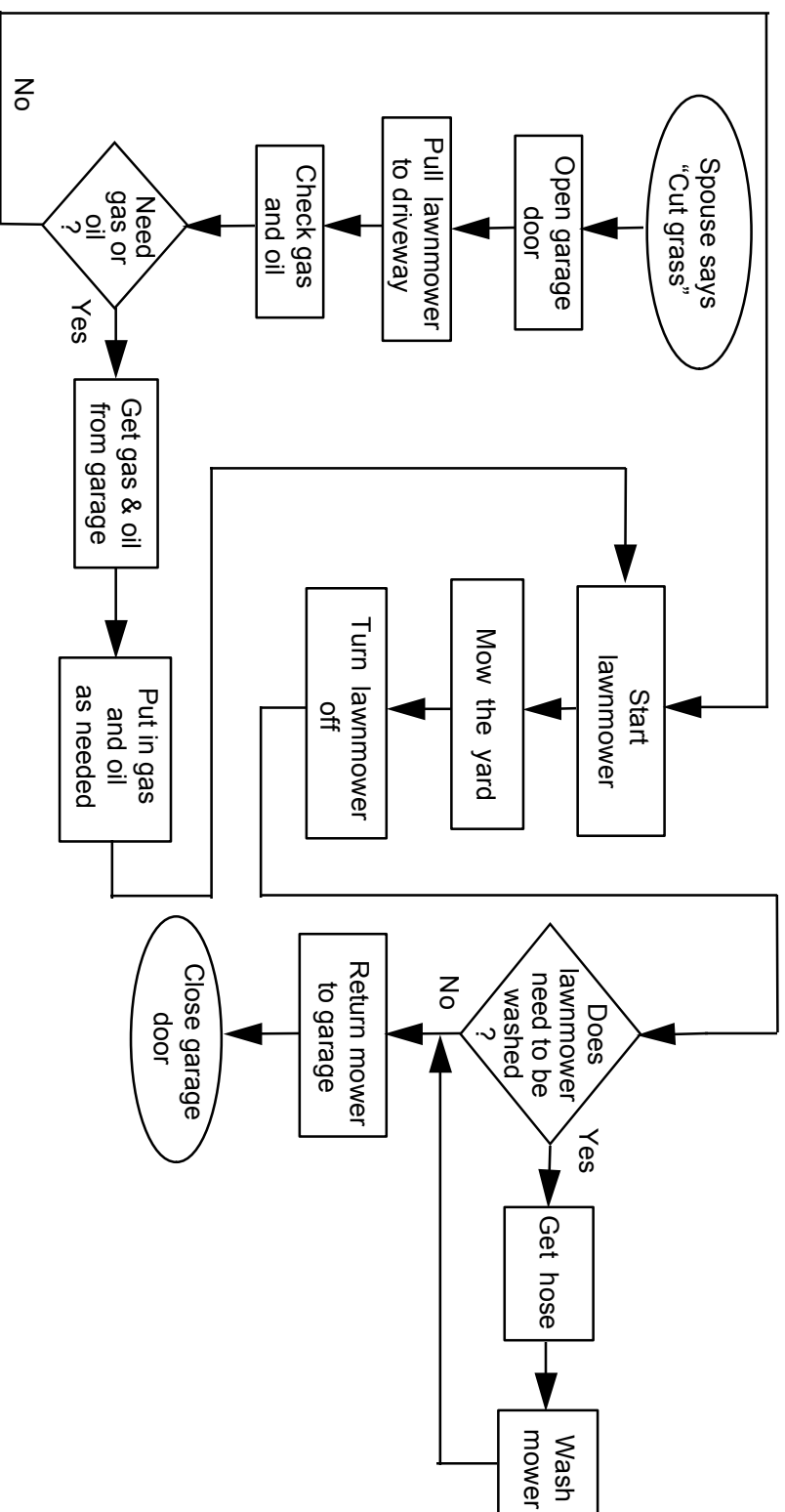
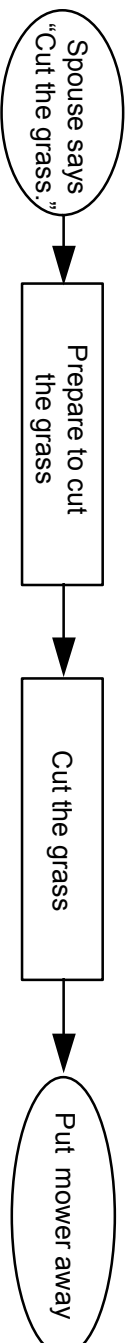

EXERCISE 3

Fire Drill Preparation Flowchart

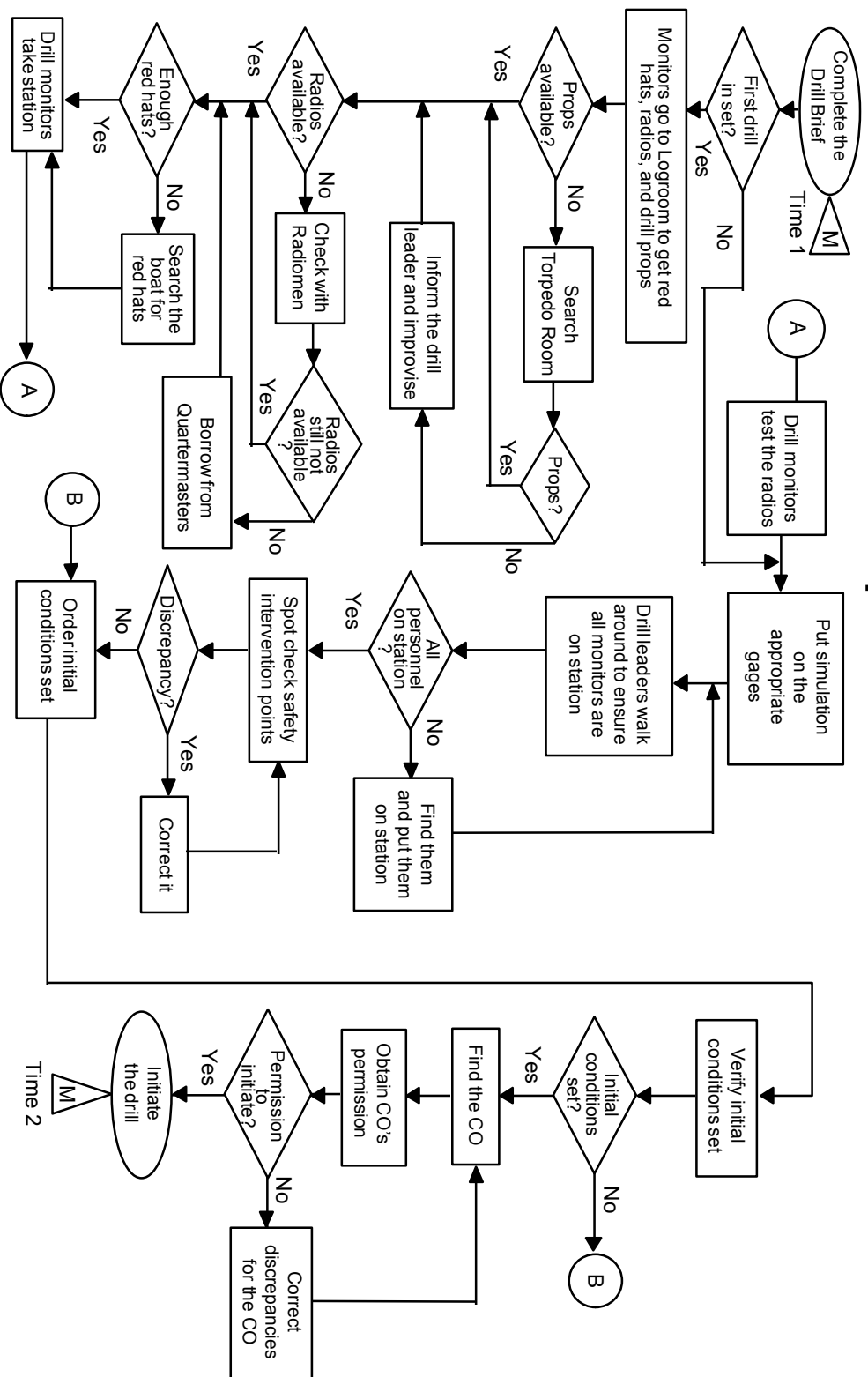

FLOWCHART

VIEWGRAPH 15