

**Manitex**

**Manitex**



# M150

15-ton (13,6 mt) ROUGH TERRAIN CRANE  
PRODUCT GUIDE

# M150

15-ton (13,6 mt) ROUGH TERRAIN CRANE  
PRODUCT GUIDE

**UPTIME**

UPTIME is the Manitex commitment to complete support of thousands of units working every day.

**MANITEX**  
3000 South Austin Avenue  
Georgetown, Texas 78626  
1-877-314-3390 | [www.Manitex.com](http://www.Manitex.com)

# CONTENTS

Crane Features ..... 4  
 Boom Diagram ..... 5  
 Crane Weights ..... 5  
 Load Chart: Main Boom & Jib - On Outriggers ..... 6  
 Load Chart: Main Boom - On Tires ..... 7  
 Reeving Diagram ..... 7  
 Area of Operation ..... 8  
 Crane Dimensions / Outrigger Extension ..... 9  
 Technical Descriptions ..... 10 - 11  
 Options ..... 11

Effective Date: February 17, 2014  
 This document is non-contractual. This document is supplied for reference use only. We are constantly making improvements to our products and reserve the right that specification, equipment, and prices are all subject to change without notice or obligation.  
 The photographs, and /or images in this document are for illustrative purposes only and may include optional equipment and accessories and may not include all standard equipment.  
 Refer to the appropriate Operator's Manual and Load Charts for instructions on the proper use of this equipment to determine allowable crane lifting capacities, assembly and operating procedures.  
 Failure to follow the appropriate operator's manual or load chart(s) when using our equipment or to otherwise act irresponsibly may result in serious injury or death.  
 The only warranty applicable to our equipment is the standard written warranty applicable to the particular product and sale. Manitex makes no other warranty, expressed or implied.  
 Products and services listed may be trademarks, service marks or trade-names of Manitex International and /or its subsidiaries in the USA and other countries.  
 All rights are reserved. Manitex® is a registered trademark of Manitex International, Inc. in the USA and many other countries.  
 Copyright 2013 Manitex Inc. Manitex Inc., Georgetown Texas, 78626



# TECHNICAL DESCRIPTIONS & OPTIONS

## Control System



Armrest mounted dual axis electro-proportional joysticks  
 Steering wheel column with gear selector on the right and directional light selector on the left  
 Dashboard mounted switches for outrigger operation

## Cab



- Standard features:
- Rubber floor mat
  - Tinted safety glass
  - Six way adjustable seat
  - Heater/Defroster
  - Window wiper with washer and top window
  - Two lockable doors with sliding windows

## Hydraulics



Hydraulic pump: axial piston  
 69.5 gpm (263 lpm) @ 3,500 psi (241 bar)  
 Hydraulic oil reserve capacity: 75 gal. (284 L)  
 Hydraulic oil suction filter: 850 microns with magnet  
 Hydraulic oil return filter: 10 microns

## Engine



Cummins® QSB4.5 Tier 3, 4 cylinders  
 Rated power: 160 hp (119 kW) @ 2,500 rpm  
 Maximum gross torque: 460 ft.-lb. (624 Nm) @ 1,500 rpm  
 Intake: Turbocharger with intercooler  
 Fuel type: Diesel  
 Fuel tank capacity: 50 gal. (189 L)

## Tires



Wide tread earth mover pattern 17.5 x 25-20 PR

## Drive-line



6 x 6 powershift transmission with integral torque converter  
 4WD (Four-Wheel Drive) with rear axle disconnect  
 Rigid mounted front axle  
 Dampened rear axle  
 Limited slip on front axle  
 Hydraulic over-hydraulic drum brakes  
 Parking brake on front axle  
 Hydraulic oil cooler on carrier

## Steering



Hydraulic power steering  
 Front wheel steering  
 Four wheel steering coordinated  
 Four wheel crab steering  
 Independent rear wheel steering package  
 Rear wheel centering light indication

## Options

### Jib



1-section fixed jib: 20 ft. (9,5 m)

### Hoist, Rope and Hook



Two speed winch



Low profile load block: 456 lb. (207 kg)

### Cab



Air conditioner	Perimeter lights
LED work lights	Rear view camera
LED strobe light	Front windshield guard

### Engine



Cummins® QSB 4.5 L 160 HP Tier 4 interim engine

# TECHNICAL DESCRIPTIONS

## Boom

 Boom length: 3-section 62.5 ft. (19,1 m) proportional boom  
Min. boom length: 24 ft. (7,3 m)

 Max. tip height: 85.5 ft. (26,1 m)

 Boom angle (min/max): 0° / 70°

## Rotation

 Planetary reducer  
Hydraulic motor

 Slewing brake: Spring-applied hydraulic released brake  
360° house lock - manually applied

 Boom rotation: 360° continuous  
Slewing speed: 0 - 4.5 rpm

## Outriggers

 Outriggers: Hydraulic, independent extension  
Outrigger pad size: 16 in. x 16 in. (406 mm x 406 mm)  
Area of outrigger pads: 256 in.<sup>2</sup> (1,652 cm<sup>2</sup>)

## Counterweight

 Counterweight: 7,500 lbs. (3,402 kg)

## Operator aids

 Graphic interface for load indicator

## Electrical System

 State-of-the-art, weather-resistant components throughout  
Hermetically sealed enclosure includes power in relays and circuit status LEDs

## Hoist, Rope and Hook

 Maximum line speed:  
Without load in 5th layer (low/high range)

- Single speed (standard): 242 fpm (1,23 mps)
- Two-speed (optional): 297 fpm (1,78 mps)

Without load in 1st layer (low/high range)

- Single speed (standard): 169 fpm (0,85 mps)
- Two-speed (optional): 207 fpm (1,05 mps) / 229 fpm (1,16 mps)

 Maximum line pull: 1st layer low-range

- Single speed (standard): 10,750 lbs. (4,876 kg)
- Two-speed (optional): Low speed 11,350 lbs. (5,148 kg)

Maximum line pull permissible

- Single speed (standard): 7,500 lbs. (3,402 kg)
- Two-speed (optional): High speed 7,140 lbs. (3,239 kg)

 Main winch cable diameter: 0.56 in. (14,2 mm)

 Line length: 390 ft. (119 m)

 6 x 19 IWRC XIPS, right regular lay, preformed

 Main winch: electrically activated, single speed hydraulic motor (standard)

 7T hook and ball: 113 lbs. (51 kg)



Load block: 2-sheaves: 495 lbs. (225 kg)

## Maximum Speed

 Maximum speed (6th gear)

- Cummins® Engine 26 mph (42 kph)

# KEY

	Engine		Mechanical transmission
	Steering		Tires
	Gross vehicle weight		Maximum speed
	Weight on rear axle		Hydraulics
	Standard (without hook block)		Weight on front axle
	Operator aids		Swing on jib
	Cab		Lifting on wheels / Pick & Carry
	Electrical system		Maximum gradeability
	Controls		Hook block
	Hoist speed		Distance from hook to head sheave pin
	1 - Main hoist 2 - Auxiliary winch 3 - Recovery winch		Hook and ball
	Rope length		Boom elevation angle
	Rope - standard/optional		Max. boom length with extension
	Rope diameter		Boom with extension retracted
	Maximum line pull		Working radius
	Slewing / Allowable slewing range		Boom length
	Slewing gears		Hydraulic actuated boom
	Slewing brake		Full power mechanical synchronized
	Outriggers / Lifting on outriggers		Boom head / Hook block dimension
	Counterweight		Tip height



## THE M150 ROUGH TERRAIN CRANE

Big job? Small space? No problem!

The cab-down M150 is just over 11 ft. tall, which makes it an ideal choice when space is limited. But don't be fooled by its compact size. This low-profile crane is designed for high performance. It offers:

- 4-wheel drive and 4-wheel steering so it maneuvers effortlessly - even in very tight spots
- Multiple boom configurations
- Highly visible, ergonomically engineered two-door cab with joystick controls
- Integrated features such as steps and handrails

### Other features include:

- 15-ton capacity, 10 ft. rated distance from center of rotation
- 62.5 ft. max. boom length
- 85.5 ft. max. boom tip height
- Optional 20 ft. jib
- Full Load Moment Indicator and Anti-two Block system

### SEE CLEARLY

With its low profile, sliding glass door and expansive use of glass, you'll never lose sight of your load. The two-door cab offers maximum space for maximum comfort.



### LIFT CONFIDENTLY

In a pick and carry, there's no room for unpredictability. The M150's joystick controls are easy to use and responsive, so you're always in command.



### GET IN AND OUT EASILY

Stop climbing over tires to reach the cab. With the M150, front-mounted steps and cab-mounted handrails make getting in and out easy.



## CRANE DIMENSIONS / OUTRIGGER EXTENSION

Imperial & Metric Units

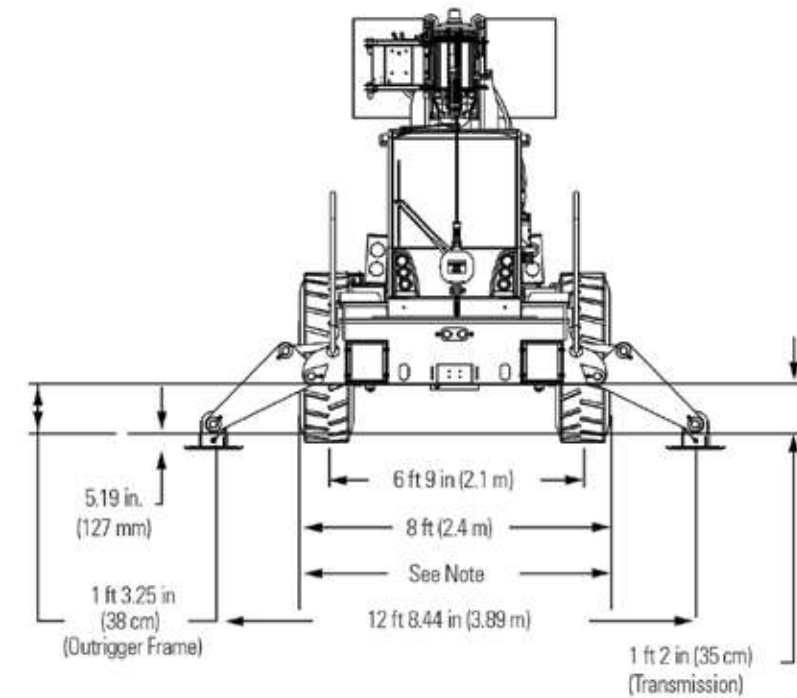
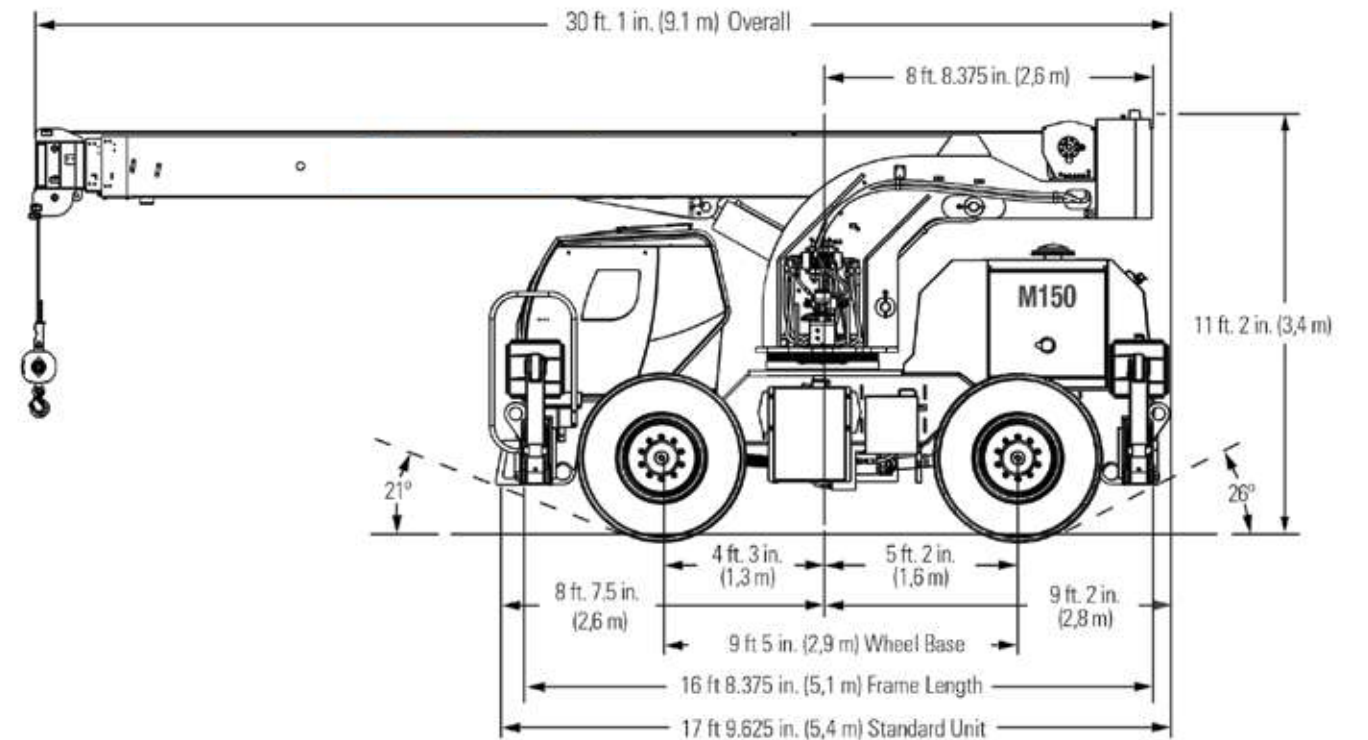

**NOTE:**

Tire Size:	14.00 x 24	17x25
Track width:	6 ft. 9 in. (2.1 m)	6 ft. 9 in. (2.1 m)
Overall width:	7 ft. 11.8 in. (2.4 m)	8 ft. 4.9 in. (2.6 m)

Notes: Additional axles required for federal bridge legal configuration - consult Manitex. Manitex highly recommends the addition of a front stabilizer and it may be required on some installations - consult Manitex.



# AREA OF OPERATION

## On Outriggers

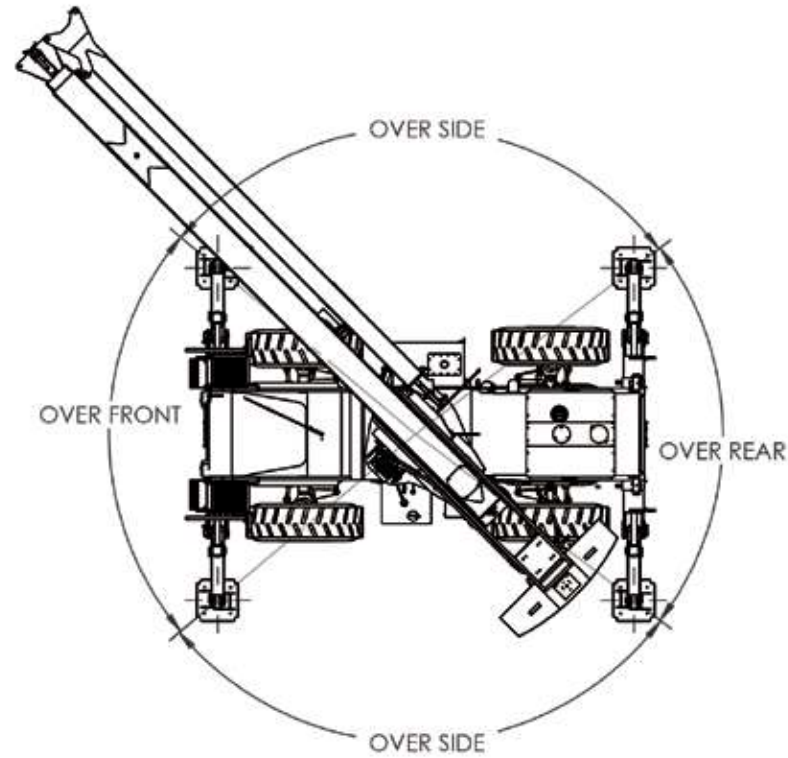

## On Tires

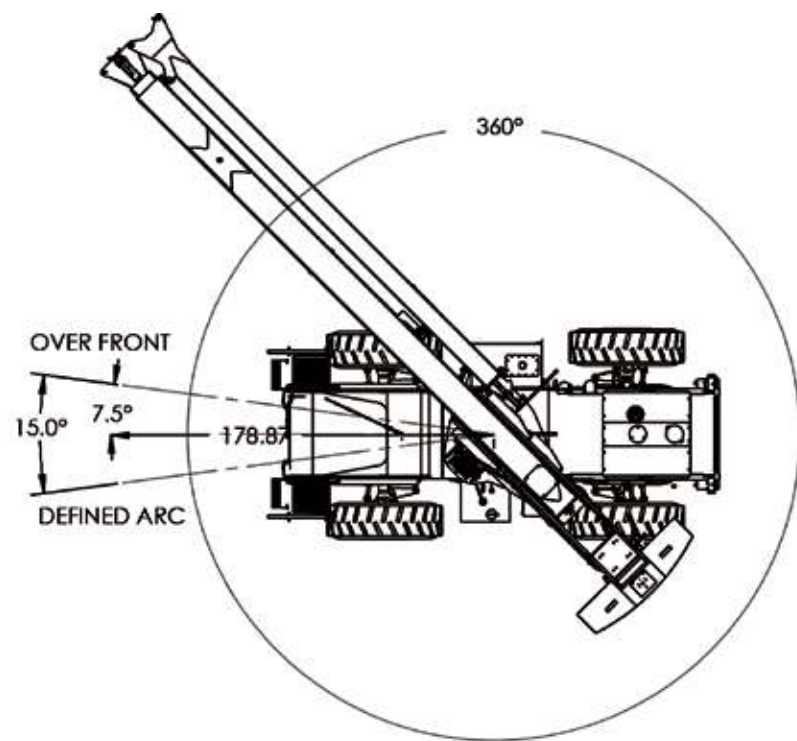





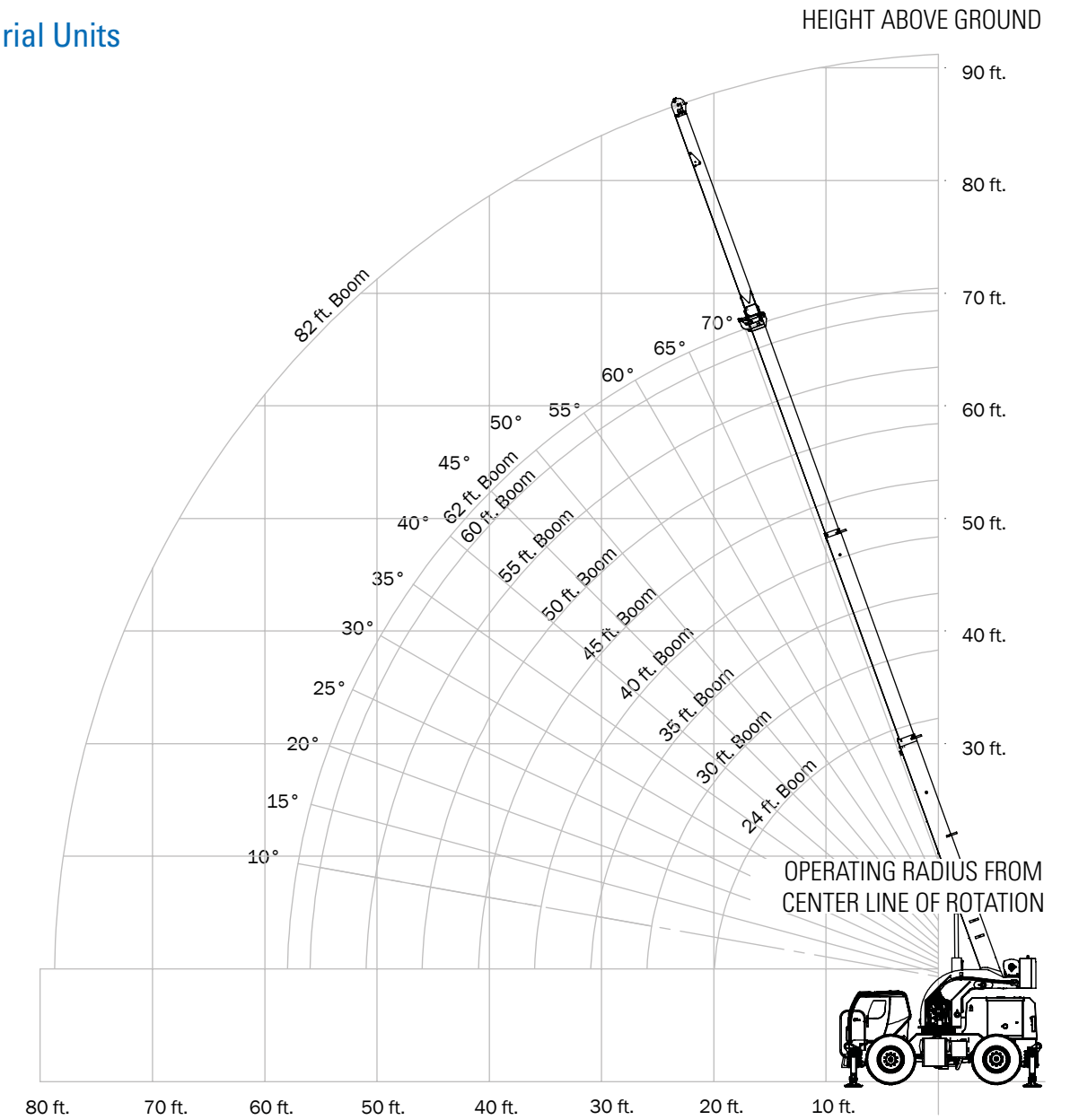

# BOOM DIAGRAM

## Imperial Units



# CRANE WEIGHTS

			
 Standard (Without hook block)	41,800 lbs. (18,960 kg)	17,480 lbs. (7,929 kg)	24,324 lbs. (11,033 kg)
 24 ft. (7,3 m) to 62 ft. (18,9 m)	+609 lbs. (+276 kg)	+86 lbs. (+39kg)	+523 lbs. (+237 kg)
 15T (13,6 mt) 2 sheave hook block	+456 lbs. (+207 kg)	+1,249 lbs. (+567 kg)	-793 lbs. (-360 kg)
 7T (6,4 mt) hook & ball	+180 lbs. (82 kg)	+493 lbs. (+224 kg)	-313 lbs. (-142 kg)

Data published herein is intended as a guide only. Crane operation is subject to the computer charts and operation manual supplied with the crane.

Data published herein is intended as a guide only. Crane operation is subject to the computer charts and operation manual supplied with the crane.

# LOAD CHART: Main Boom - On Outriggers

Lifting Capacities 3 Section Boom 24 ft. - 62.5 ft.  
20 ft. Fixed Jib - Imperial Units

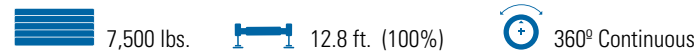

Boom Length (ft.)	24 ft. Boom			30 ft. Boom			38 ft. Boom		
	Boom Angle (deg.)	Over Front (lbs.)	360° (lbs.)	Boom Angle (deg.)	Over Front (lbs.)	360° (lbs.)	Boom Angle (deg.)	Over Front (lbs.)	360° (lbs.)
10 ft.	55°	30,000	30,000	62°	30,000	30,000	68°	30,000	30,000
12 ft.	49°	30,000	30,000	58°	30,000	30,000	65°	28,000	28,000
14 ft.	42°	26,300	26,300	53°	26,400	26,400	62°	25,300	25,300
15 ft.	39°	24,400	24,400	51°	24,600	24,600	60°	24,000	24,000
16 ft.	35°	22,800	22,800	48°	23,000	23,000	58°	23,000	23,000
18 ft.	25°	20,100	20,100	43°	20,300	20,300	55°	20,400	20,400
20 ft.	11°	17,900	17,900	37°	18,100	18,100	51°	18,200	18,200
22 ft.				30°	16,300	16,100	47°	16,500	16,200
24 ft.				21°	14,800	14,000	43°	15,000	14,200
25 ft.				16°	14,200	13,200	40°	14,300	13,400
26 ft.				6°	13,500	12,400	38°	13,700	12,600
28 ft.							33°	12,600	11,300
30 ft.							27°	11,300	10,200

Boom Length (ft.)	46 ft. Boom			54 ft. Boom			62.5 ft. Boom		
	Boom Angle (deg.)	Over Front (lbs.)	360° (lbs.)	Boom Angle (deg.)	Over Front (lbs.)	360° (lbs.)	Boom Angle (deg.)	Over Front (lbs.)	360° (lbs.)
12 ft.	70°	22,500	22,500						
14 ft.	67°	20,900	20,900						
15 ft.	66°	20,100	20,100	69°	17,000	17,000			
16 ft.	64°	19,600	19,600	68°	16,400	16,400			
18 ft.	61°	18,300	18,300	66°	15,400	15,400			
20 ft.	58°	17,200	17,200	64°	14,600	14,600	67°	12,700	12,700
22 ft.	56°	16,300	16,300	61°	13,900	13,900	65°	12,000	12,000
24 ft.	52°	15,000	14,300	59°	13,100	13,100	63°	11,300	11,300
25 ft.	51°	14,400	13,400	57°	12,800	12,800	62°	10,900	10,900
26 ft.	49°	13,800	12,700	56°	12,400	12,400	61°	10,600	10,600
28 ft.	46°	12,700	11,400	54°	11,700	11,300	59°	10,100	10,100
30 ft.	42°	11,400	10,300	51°	11,000	10,200	57°	9,500	9,500
35 ft.	32°	9,100	8,200	44°	9,000	8,200	51°	8,400	8,300
40 ft.	17°	7,400	6,700	35°	7,400	6,700	45°	7,500	6,900
45 ft.				25°	6,200	5,600	38°	6,400	5,800
50 ft.				4°	5,300	4,800	30°	5,400	4,900
55 ft.							19°	4,700	4,300

20 ft. Jib on Outriggers			
Boom Angle (deg.)	360° (lbs.)	Boom Angle (deg.)	360° (lbs.)
70°	6,500	30°	2,900
60°	4,800	20°	2,700
50°	3,900	10°	2,600
40°	3,300		

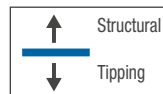

EZ Reeve® Hook Block: 72.5 in. (1.84 m)  
Low profile (flat-top): 60.5 in. (1.54 m)

# LOAD CHART: Main Boom - On Tires

Lifting Capacities 3 Section Boom 24 ft. - 62.5 ft.  
Imperial Units

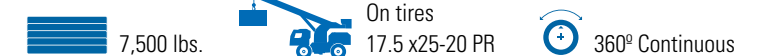

Boom Length (ft.)	24 ft. Boom			30 ft. Boom			38 ft. Boom		
	Boom Angle (deg.)	Over Front (lbs.)	360° (lbs.)	Boom Angle (deg.)	Over Front (lbs.)	360° (lbs.)	Boom Angle (deg.)	Over Front (lbs.)	360° (lbs.)
10 ft.	55°	24,500	19,500	62°	24,700	19,660	68°	24,800	19,800
12 ft.	49°	17,800	14,600	58°	18,000	14,800	65°	18,100	14,900
14 ft.	42°	13,900	11,600	53°	14,000	11,700	62°	14,100	11,900
15 ft.	39°	12,500	10,500	51°	12,600	10,600	60°	12,700	10,700
16 ft.	35°	11,300	9,600	48°	11,400	9,700	58°	11,500	9,800
18 ft.	25°	9,400	8,000	43°	9,600	8,200	55°	9,700	8,300
20 ft.	11°	8,000	6,900	37°	8,200	7,000	51°	8,300	7,100
22 ft.				30°	7,100	6,100	47°	7,200	6,200
24 ft.				21°	6,200	5,400	43°	6,400	5,500
25 ft.				16°	5,900	5,100	40°	6,000	5,200
26 ft.				6°	5,500	4,800	38°	5,700	4,900
28 ft.							33°	5,100	4,500
30 ft.							27°	4,600	4,000

Boom Length (ft.)	46 ft. Boom			54 ft. Boom			62.5 ft. Boom		
	Boom Angle (deg.)	Over Front (lbs.)	360° (lbs.)	Boom Angle (deg.)	Over Front (lbs.)	360° (lbs.)	Boom Angle (deg.)	Over Front (lbs.)	360° (lbs.)
20 ft.	58°	8,300	7,200						
22 ft.	56°	7,300	6,300						
24 ft.	52°	6,400	5,600						
25 ft.	51°	6,000	5,200						
26 ft.	49°	5,700	5,000						
28 ft.	46°	5,100	4,500						
30 ft.	42°	4,600	4,000						
35 ft.	32°	3,700	3,200	44°	3,700	3,200			
40 ft.	17°	3,000	2,600	35°	3,000	2,600			
45 ft.				25°	2,500	2,100	38°	2,600	2,200
50 ft.				4°	2,000	1,700	30°	2,100	1,800
55 ft.							19°	1,800	1,600
	60°	Max. Angle		50°	Max. Angle		45°	Max. Angle	

## REEVING DIAGRAM - Line Parts

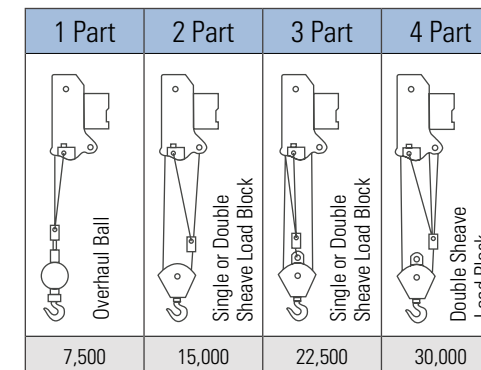

### NOTES:

- Deduct 400 lbs. for stowed jib
- Deduct 1,000 lbs. for erect jib
- 17.5 x 25.20 ply tires, 90 psi recommended tire pressure
- Loads above heavy line are based on structural rating
- Loads below heavy line are based on tipping rating
- Lifting with jib on tires is not permitted
- All "On Tires" tipping loads are based on 75% tipping
- Rotation of erect jib is allowed with boom fully retracted, creep only
- Transport of erect jib is allowed with boom fully retracted, 5mph max
- Boom angles are undeflected boom angles
- 9/16" - 6 x 19 class - 6 x 25 FW, PRF, RRL, XIP, IWRC Wire Rope
- These load ratings are for lift service only.
- Pick & Carry permissible only with boom and load centered over front.
- Weight of hook blocks and slings is part of the load, and is to be deducted from the capacity ratings. Consult operation manual for further details.

