



--- Telescoping Wall-Mounted Basketball Systems ---
Stationary Model (24" - 144")
Installation Instructions

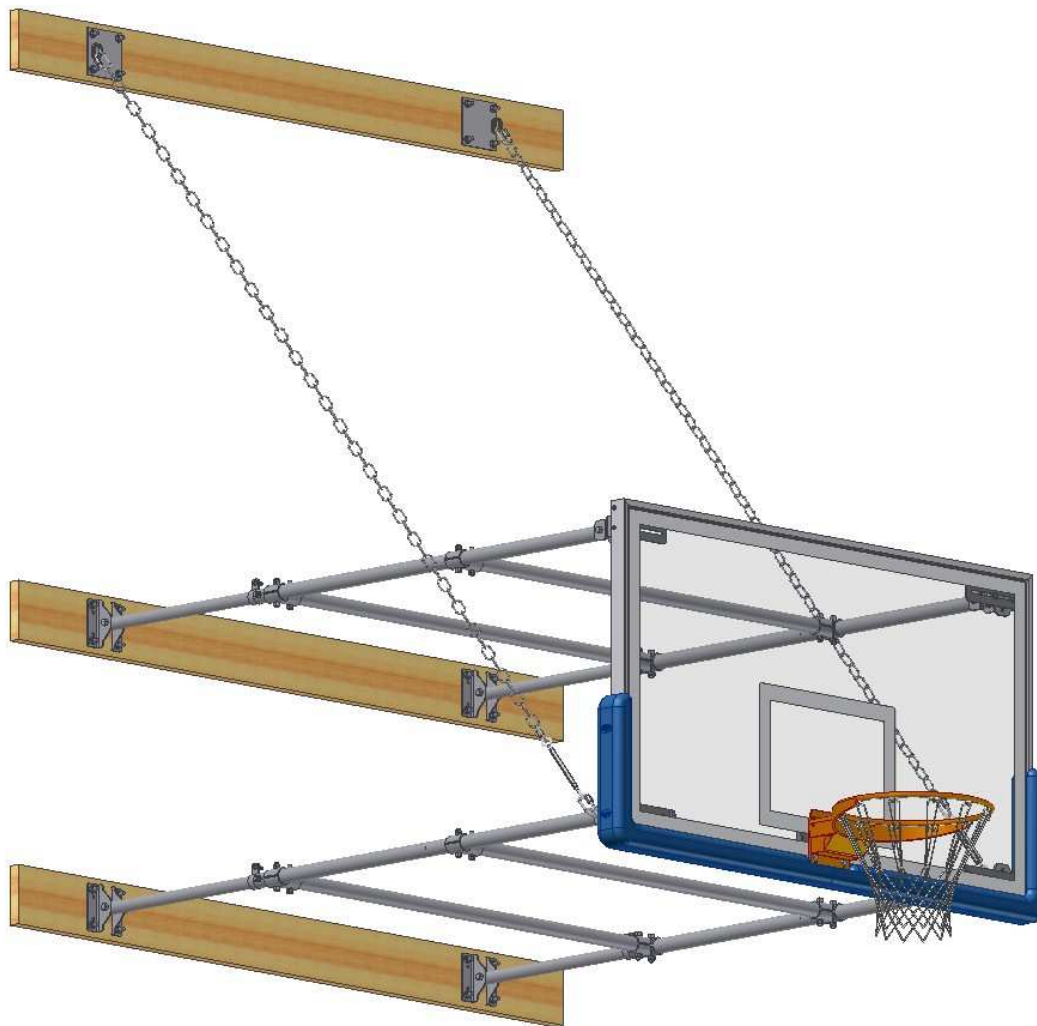

Figure 1: Jaypro Stationary Wall Mounted Backstop

Call Jaypro Sports Equipment at 1-800-243-0533 during regular business hours for technical support.

www.jaypro.com

Important Notes

- Follow all warning signs and labels on equipment.
- Inspect all equipment before each use.
- Use the proper anchor depending on wall type. Consult ‘Anchor Management’ section in this manual for proper selection.
- Acoustic block or ‘sound block’ is the worst possible masonry type for wall mounts. The block facing is textured, and there are slots every couple of inches. The block must be filled solid at all attachment areas or failure is likely!
- Wall must be capable of supporting the entire load of the backstop and accessories, as well as handling the shock effect of a large player slamming the ball and/or hanging on the rim.
- Integrity of the wall must be verified by an architect or structural engineer. See enclosed weight table for possible loading on the wall.
- Over the course of time anchors and bolts/nuts may loosen as a result of vibration during equipment use. Periodic inspection and rework is strongly advised to tighten hardware and return equipment to original level of safety.
- All wall anchor hardware should be a minimum of ½” diameter.
- Preventive maintenance should be performed annually on all our basketball backstops to insure years of safe, trouble-free use. This work must be completed by a qualified installer or technician. If one is not available to you, Jaypro’s own field service team can be hired to do the work – call Jaypro for pricing and scheduling. See Appendix C for standard equipment maintenance instructions.

***** Important! *****

Following all guidelines for installation is absolutely critical to insure a successful and safe installation of wall mounted equipment. Be especially careful with regards to wall anchor selection and preparation. Follow all manufacturer’s instructions for proper use of specific wall anchors. Jaypro does not supply wall anchors with wall mounted equipment, but they can be purchased directly from factory. Wall composition must be brick, concrete, or other form of solid or semi-solid masonry for the backstops to be supported securely. If wall composition is studded with either wood or steel, or there are obstructions or other such building features that make a standard installation inappropriate or impossible, do not attempt installation without first contacting Jaypro directly for a custom engineered solution. Jaypro will not assume liability for the installation of any wall mounted unit.

Table of Contents

1. Tools & Equipment Required.....	4
2. Preparation.....	4
3. Drilling of Wood Planks.....	6
4. Wall Anchors	6
5. Stationary Unit Assembly (24" to 144" Face of Bank)	7
Appendix A – Anchor Management	11
Hilti Kwik Bolt 3 [Expansion Anchor].....	12
Hilti Kwik Bolt 3 [HIT HY 150 Adhesive Anchor System]	13
No. 1 Type Tumble Toggle	15
½" “Double” Dual Expansion Machine Bolt Anchor.....	15
Appendix B – Weight Tables	16
Appendix C – Equipment Maintenance	16

Table of Figures

Figure 1: Jaypro Stationary Wall Mounted Backstop.....	1
Figure 2: Minimum Wall Height Table	5
Figure 3: Attachment Heights	5
Figure 4: Inner Telescoping (1.66" Dia) Pipe Cut & Insertion Diagram	7
Figure 5: Glass Backboard Inner Telescoping Pipe Lengths.....	Error! Bookmark not defined.
Figure 6: Fan Aluminum Backboard Inner Telescoping Pipe Lengths	8
Figure 7: Hoisting Strap Location for Backboard.....	9
Figure 8: Top vs. Bottom Chain Attachment.....	10
Figure 9: Wood Plank Anchor Locations	11
Figure 10: Recommended Anchors for Wall Types	12
Figure 11: Recommended Torque for Kwik Bolt 3 (Expansion Anchor)	12
Figure 12: Allowed Anchor Locations for Concrete Masonry Unit (CMU).....	13
Figure 13: Gel and Cure Times for Kwik Bolt 3 (Adhesive Anchor)	14
Figure 14: Wall Mount Weights (Lbs).....	16

***** Authorized Personnel Only *****

Installation Instructions

1. Tools & Equipment Required

- a. Socket set and/or box wrenches
- b. Adjustable wrench or 19/32 open end box wrench (for closing quick links)
- c. Backboard lifting equipment (500 lb capacity minimum):
 - a. Manual material lift or
 - b. Block and tackle or
 - c. Chain hoist or
 - d. Cable winchNote: if any of the last three methods is used, two nylon web lifting straps (or similar product) will be needed as well, plus shackles.
- d. Electric drill with the following bits:
 - a. 3/4" wood
 - b. 9/16" carbide tipped or better (for drilling steel pipe)
- e. Medium to heavy duty rotary hammer with the following masonry bits (depending on anchor type – see Appendix A for selection):
 - a. 1/2"
 - b. 3/4"
 - c. 7/8"
- f. Rubber hammer or mallet (for minor leveling adjustments and hardware assembly)
- g. Bolt cutters (optional)
- h. Hacksaw or reciprocating saw with hacksaw blades
- i. 4' Level
- j. Measuring tape (at least 25' long)
- k. Assembly diagrams specific for type of backboard and Face of Bank (shipped with materials – contact Jaypro if you are missing your set of assembly diagrams).

2. Preparation

- a. Begin by laying out all parts. Identify everything listed on packing list and parts lists and make sure everything is accounted for.
- b. Familiarize yourself with the installation drawing packet supplied with the job. If you don't understand something on any of the drawings, now is the best time to contact Jaypro and get the answers to your questions.
- c. Obtain correct anchors for the wall type present. See table below for guidance. Important: It is the responsibility of the installer to supply the correct anchor. Jaypro cannot be held liable should the wall anchors fail.
- d. Determine the exact location for your backstop. Avoid obstructions such as windows, exposed columns, conduit, etc. on or in the wall in the area where the backstop is to be located. An area 8' wide, from 9'6" to approximately 20' from the floor is required for installations. The height of each of the wood planks is determined by the backboard type, and the distance of the backboard from the wall (specific minimum height given in the table below).
- e. Remove any sheetrock or other wall covering from area immediately behind the wood planks.

<u>Unit Style</u>	<u>Description</u>	<u>Face of Bank</u>	<u>Minimum Block Height</u>
ST24	Stationary	24" - 48"	18'
ST46	Stationary	49" - 72"	Face of Bank + 10'-6"
ST68	Stationary	73" - 96"	Face of Bank + 10'-6"
ST812	Stationary	97" - 144"	Face of Bank + 10'-6"

Figure 2: Minimum Wall Height Table

- f. The wall surface that the backstop structure is attached to must be capable of supporting the backstop and the forces applied when it is in play. Concrete block, brick, or solid concrete walls are ideal. If your walls are any other material please contact Jaypro Sports for suggested attachment methods (also see 'Anchor Management' section later in this manual).
- g. Determine location of top wood member so that support chains are optimally kept at 45°. The diagram below shows attachment heights for all wall structure.

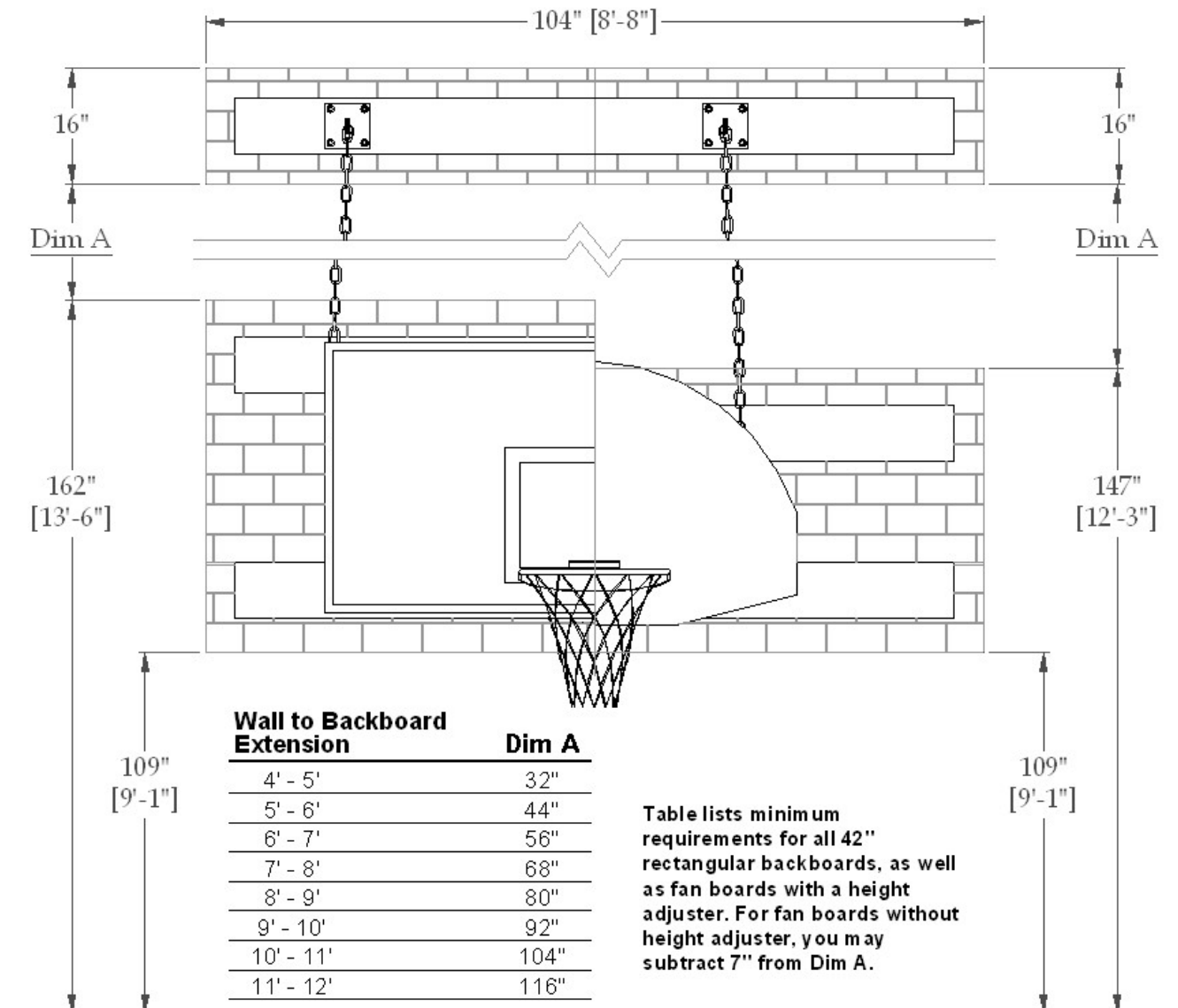

Figure 3: Attachment Heights

3. Drilling of Wood Planks

- a. The wood planks for attaching to the wall are predrilled for their specific brackets. Lay these out on a sawhorse or similar work area. You will need to drill them for anchor bolt locations.
- b. It is best to use ½” anchors for the wall, therefore a ¾” hole in the wood plank is desirable to allow for leveling the plank. Set up a drill with a ¾” wood drill bit.
- c. When marking the planks, mark and drill from the front of the plank, the side facing away from the wall. This will be exposed as a finished product, so mark lightly. You need to drill from this side in order to prevent splintering when drilling
- d. Pulley and chain attachments are mounted to 96” planks. These are critical attachments, 8 anchors per plank are required.
- e. Stagger the anchors from side to side leaving 2” of wood outside each anchor and ultimately using 8 anchors for the plank.
- f. It is very important that these holes are drilled as straight as possible through the planks, otherwise it becomes difficult to level them.

4. Wall Anchors

- a. Now you are ready to transfer this layout to the wall for drilling. Determine the centerline of the unit from the drawings and architectural drawings. Determine the width of the frame from your installation drawings. The bottom frame attachment is indicated on your drawings, this will dictate the location of your bottom hole. Relate this point to your anchor pattern. Mark a centerline of the plank starting at your bottom anchor location and extending to the top anchor location. Mark the actual hole locations to each side of the center as they are located on the plank. Try to avoid mortar joints they often contain wire mesh and are weaker than the surrounding block. The planks may be shifted up or down slightly to avoid the mortar joints. Continue marking pulley and/or chain locations. These points may also be shifted slightly to obtain desired anchor locations. Avoid attachment in the top 2 to 3 rows of block, this will cause the blocks to break away.

Important! Remove any sheetrock or other non-structural materials from area immediately behind all wood planks. This material will interfere with the wall anchors. Failure to remove drywall or other such material may result in the entire backstop unit falling off the wall.

- b. After marking all the anchor locations, double check before drilling. Make certain they are at the right height, width, and distance apart. If you are over a finished floor, make certain to protect the area prior to drilling. A box taped to the wall under each hole as you drill will catch a large portion of the dust. Drill all holes before attaching the planks. See Appendix A – Anchor Management for specific details on anchor installation.
- c. Clean the area thoroughly before proceeding to prevent spreading masonry dust.
- d. Determine the proper anchor for each location. This is IMPORTANT. Do not try to use an anchor that is not suited to the location. For instance, don't use an expansion anchor in a hollow wall application. Suitable toggle bolt anchors are available. If you carry a variety to allow for different applications, you will save yourself a huge amount of time and trouble, and do a better job at the same time. If you use a double expansion anchor, make sure you use a back-up washer between the wall and plank to prevent the anchor from pulling into the wood. Use a suitable washer at the face of the plank to cover the hole. 1-1/2” outside diameter works well.

5. Stationary Unit Assembly (24" to 144" Face of Bank)

- Prepare the wood planks for installation by attaching all brackets with carriage bolts provided. Place brackets loosely in place before attaching planks to wall.
- Attach each plank loosely, to allow for leveling. Level and tighten the planks securely to the wall and cut off excess bolts protruding from the wall. Maintain center-to-center dimensions and height requirements as accurately as possible to make the rest of the installation as easy as possible.
- Attach support chains to the D-ring fittings on the top plank(s) before attempting to assemble the frames, these are normally needed to support the frames after raising them. It is easier to have them in place before proceeding. For units over 48" Face of Bank, assemble the turnbuckles at the other end, turning each eyebolt halfway out.
- Assemble four (4) support pipes by first sliding brace bands onto the 1.66" inner pipe. Then slide the outer 1.90" pipes over the inner pipes until they reach the brace band. Consult table below for correct location based on desired face of bank dimension.

Note: these dimensions are accurate to within 1/2". For greater accuracy, actual backboard to wall measurements will need to be taken during final assembly (before drilling permanent attachment holes).

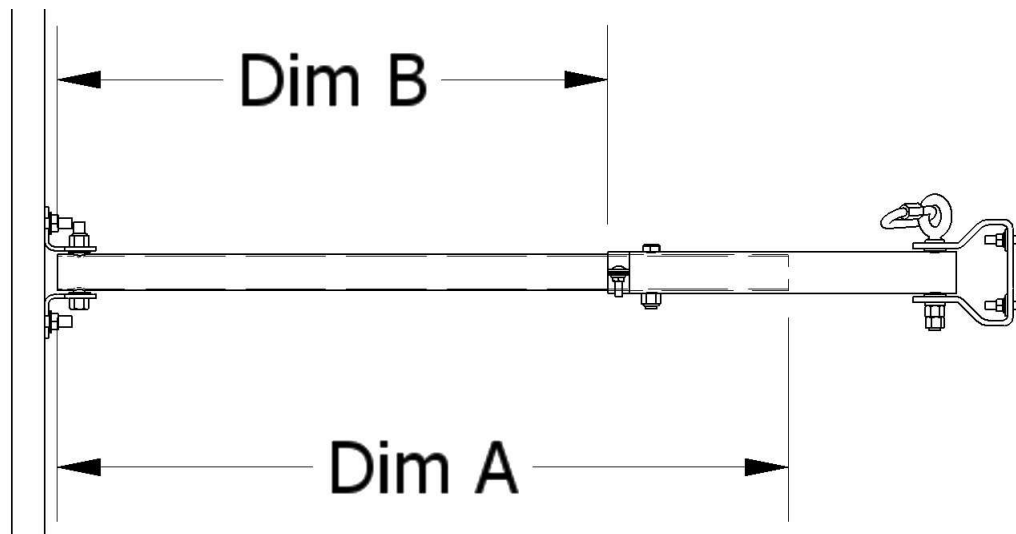

Figure 4: Inner Telescoping (1.66" Dia) Pipe Cut & Insertion Diagram

GLASS BACKBOARD			FAN ALUMINUM BACKBOARD				
Face of Bank	1.66 Cut Length (Dim A, Fig 4)	Exposed Pipe (Dim B, Fig 4)	Face of Bank	1.66 Cut Length (Dim A, Fig 4)	Lower Frame Exposed Pipe (Dim B, Fig 4)	Upper Frame Exposed Pipe (Dim B, Fig 4)	
Model ST24GB	24	15 1/2	1 1/4	24	14 1/2	1/2	2 1/8
	25	16 1/2	2 1/4	25	15 1/2	1 1/2	3 1/8
	:	:		:	:		:
	:	:	Add 1" for each additional 1" Face of Bank	:	:	Add 1" for each additional 1" Face of Bank	:
	:	:		:	:		
	:	:		:	:		
	40	31 1/2	:	40	30 1/2	16 1/2	18 1/8
	41	32 1/2	:	41	31 1/2	17 1/2	19 1/8
	42	33 1/2	:	42	32 1/2	18 1/2	20 1/8
	:	33 1/2	:	:	33 1/2	:	:
	:	33 1/2	:	:	33 1/2	:	:
	47	33 1/2	24 1/4	47	33 1/2	23 1/2	25 1/8
48	33 1/2	25 1/4	48	33 1/2	24 1/2	26 1/8	

Figure 5: 24"-48" Telescoping Frame Pipe Lengths

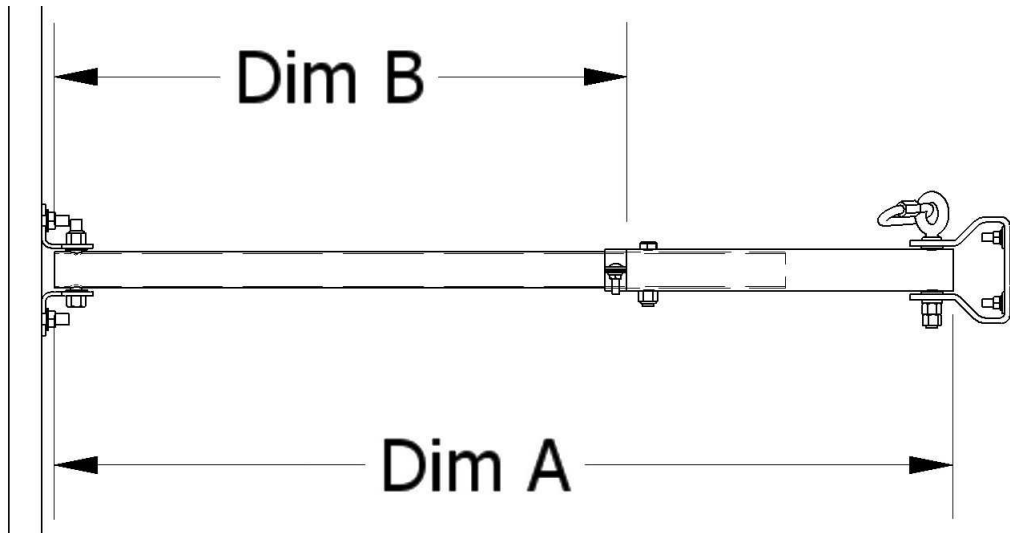

Figure 6: Telescoping Frame Pipe Insertion Diagram

GLASS BACKBOARD			FAN ALUMINUM BACKBOARD				
Face of Bank	Frame Length (Dim A, Fig 6)	Exposed Pipe (Dim B, Fig 6)	Face of Bank	Upper Frame Frame Length (Dim A, Fig 6)	Upper Frame Exposed Pipe (Dim B, Fig 6)	Upper Frame Frame Length (Dim A, Fig 6)	Lower Frame Exposed Pipe (Dim B, Fig 6)
Model ST46GB	48	41 1/4	2 1/4	48	42 1/8	3 1/8	40 1/2
	49	42 1/4	3 1/4	49	43 1/8	4 1/8	41 1/2
	:	:	:	:	:	:	:
	:	:	Add 1" for each additional 1" Face of Bank	:	:	Add 1" for each additional 1" Face of Bank	:
	:	:	:	:	:	:	:
	71	64 1/4	25 1/4	71	65 1/8	26 1/8	63 1/2
72	65 1/4	26 1/4	72	66 1/8	27 1/8	64 1/2	
Model ST68GB	72	65 1/4	2 3/4	72	66 1/8	3 5/8	64 1/2
	73	66 1/4	3 3/4	73	67 1/8	4 5/8	65 1/2
	:	:	:	:	:	:	:
	:	:	Add 1" for each additional 1" Face of Bank	:	:	Add 1" for each additional 1" Face of Bank	:
	:	:	:	:	:	:	:
	95	88 1/4	25 3/4	95	89 1/8	26 5/8	87 1/2
96	89 1/4	26 3/4	96	90 1/8	27 5/8	88 1/2	
Model ST812GB	96	89 1/4	2 3/4	96	90 1/8	49 5/8	134 1/2
	97	90 1/4	3 3/4	97	91 1/8	50 5/8	135 1/2
	:	:	:	:	:	:	:
	:	:	Add 1" for each additional 1" Face of Bank	:	:	Add 1" for each additional 1" Face of Bank	:
	:	:	:	:	:	:	:
	143	136 1/4	49 3/4	143	137 1/8	50 5/8	135 1/2
144	137 1/4	50 3/4	144	138 1/8	51 5/8	136 1/2	

Figure 7: 48"-144" Telescoping Frame Pipe Lengths

- e. Attach the board mount fittings to the end of the 1.90" pipe, using supplied eyebolts to build 2 of them. These will support the weight of the unit via the chains. The other two brackets use the hex head bolts. Consult assembly diagrams for proper location of hardware.
- f. For units less than 48" Face of Bank, some cutting of pipe may be necessary.
- g. Measure this distance from the drilled end of the inner tube and place brace band accordingly.
 - a. For the Glass backboard, build all four (4) pipes the same way.
 - b. For the Aluminum Fan backboard, the top pipes differ from the bottom pipes by 1 5/8".

- h. Attach these assembled pipes to the bottom plank first using the hex bolts provided (smaller inner pipe gets attached at the wall). Be sure to assemble flat washers provided in between pipe and fittings, as this protects the pipes from wear over time.
- i. Assemble the pipe frame at the top plank in the same manner, allow this frame to hang down and lay upon the bottom frame.
- j. Attach board mount fittings to backboard if applicable, using 3/8" carriage bolts provided at
 - a. 66" center to center for glass board.
 - b. 35" center to center for fan aluminum board.

Any unit with height adjuster will have board mount fittings; all fan boards will have them.

- k. Using a cart, roll backboard to position directly in front of pipe frames.
- l. A lifting system will need to be used to position the backboard. A manual material lift is ideal (minimum capacity 500 lbs). If another method of hoisting the board is used such as chain hoist, make sure this device is attached no lower than 15' from the floor. Additionally, nylon web straps will be needed to wrap around backboard approximately 4' apart for balance, then hooked to lifting device as shown here. Secure this at the appropriate distance from the wall, at the centerline of the rim, before proceeding. Attach to backboard and apply tension.

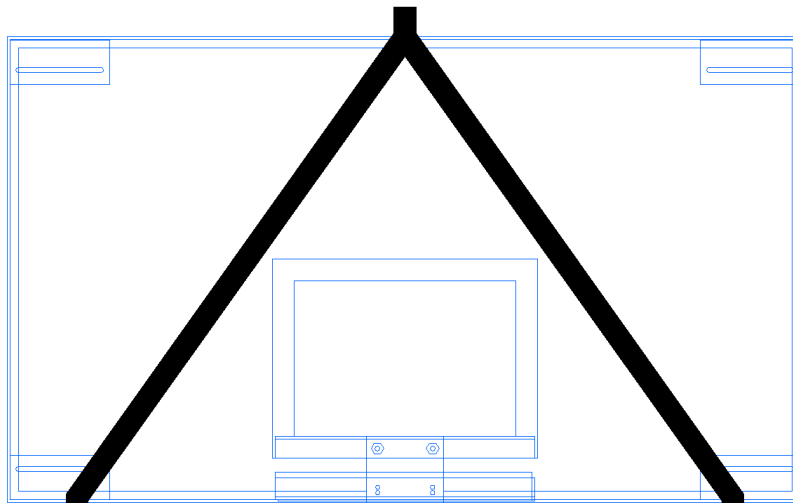

Figure 8: Hoisting Strap Location for Backboard

- m. Once the backboard is securely supported, the pipe frames can be attached at the board mount brackets. Using the appropriate hardware provided, attach the top frame first. Lift backboard as needed to allow these pipes to reach the board.
- n. Lift the board an additional 3' to 4' and attach the bottom pipes. If the unit is to be supported from the bottom, the eyebolts will be used here (make sure the eye of both eyebolts points outward).
- o. Make certain that all brackets are in place and securely tightened before proceeding, check lift mechanism.
- p. The backboard can now be raised to the proper playing height. Lift the board until the center of the top goal mounting holes are 9'-11" above the playing surface.
- q. Attach the chains to the board hinge fittings eyebolts using quick links, leveling the frames as you proceed. The chain as shipped is sized for the maximum Face of Bank, so for shorter units it may need to be trimmed after completion. Make certain that all quick-links, set nuts at turnbuckles, eyebolts, etc. are tight. Distribute weight equally between chains. Optimum angle for chains is 45°.
- r. Assemble horizontal support braces by attaching 'clamshell' pipe clamps to frame pipes, then attach cross brace pipe between the two. Do not drill holes in frame at this time
- s. Attach horizontal cross-braces:
 - a. For units 2'-4', no horizontal cross braces are required.

- b. For units 4'-6', a single brace is used. Center the brace pipe on the wall mount frame, approximate location should be half the distance from the wall to the Face of Bank.
- c. Over 6' and two (2) braces are required on each frame set. First brace pipe should be located at approximately 1/3 the distance from wall to face of bank. This may be adjusted as needed so that this brace is attached to the 1.90" outer pipe – clamps will not tighten if attached to the exposed portion of the inner 1.66" frame pipe. Second brace pipe should be centered within the remaining distance between first brace to the backboard.
- t. Verify Face of Bank for unit – measure from face of wall to the playing surface of backboard. Adjust brace bands on frame pipes as necessary. Once this has been accurately adjusted, drill holes through inner 1.66" frame pipes (use existing hole in 1.90" outer frame pipe as your guide). Secure frame pipes together permanently using hex bolt supplied. Remove brace bands.

Important! Frame pipes must be drilled as specified and permanently secured together with hex bolts. Failure to follow these instructions correctly can result in collapse of frame, and possible injury.

- u. Remove lifting mechanism.
- v. Attach the goal loosely using the bolts provided and level from side to side while tightening.
- w. Check height at the top of the goal – 10' above the playing surface.
- x. Final check all fittings and hardware to make sure everything is tight.
- y. Attach edge padding if applicable.

Note:

Chains may be optionally connected to bottom backboard mount brackets. In some assembly diagrams, chains are shown at the top board mount brackets. Either design is acceptable, although using the bottom board mount brackets will allow for lower wall attachment points for support chains. This is helpful for larger units, when there are obstructions on the wall, or the wall height is shorter than the top attachment design will allow for.

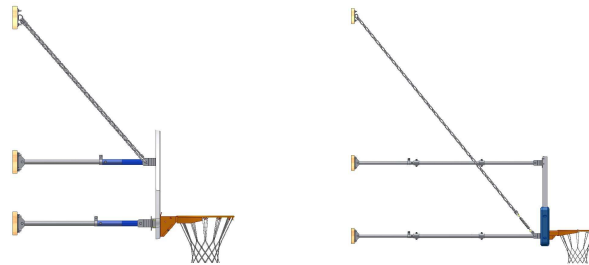
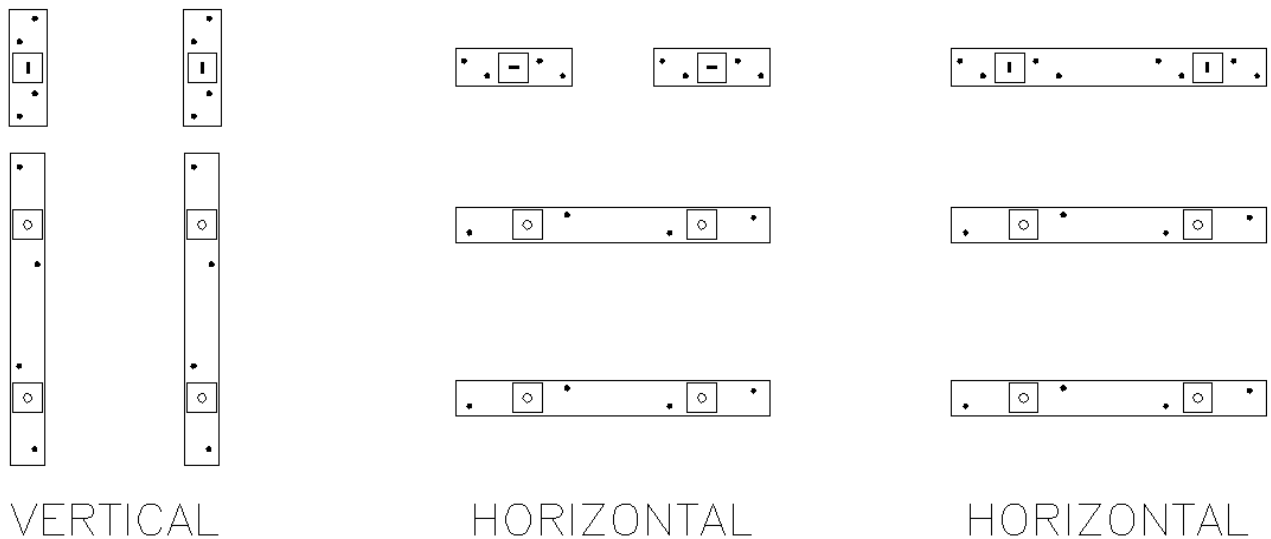

Figure 9: Top vs. Bottom Chain Attachment

Appendix A – Anchor Management

- ◆ It can be argued that the wall anchor is the most critical component of the wall mounted backstop system. All of the weight of the unit, as well as the load introduced through play and use of the equipment, ultimately must be supported by the wall anchors. Preparation of the wall, drilling of the holes in the proper location and depth, and most importantly correct selection of the type of anchor are all critical steps in the installation process.
- ◆ Due to the fact that there are so many different types of walls Jaypro is not able to supply the wall anchors with the backstop unit at the time of shipment. We do, however, stock most common types and you can purchase the anchors from us directly.
- ◆ All wall anchor hardware should be a minimum of 1/2" diameter.
- ◆ Below are diagrams showing preferred anchor pattern for various sizes of wood planks. These are intended only as a general guide. Field conditions and obstructions, mortar joints and CMU web/cavity locations, sound proof blocking, all these present situations which must be handled in the best way possible to insure a proper wall mounted installation.
- ◆ It is highly recommended that the top planks be secured with thru-bolts. The majority of the load of the backstops is transferred directly to these points. In the case of low ceilings or roof structure, the top chain attachment points may be made directly to building steel. This is not an option for 1500 side folding units, only 1310 stationary and 1400 fold-up models. Note that with the 1400 you may be limited in the amount the unit can fold if roof structure is used.
- ◆ Use a minimum of 4 anchors for each manual or electric winch attachment point. Consult drawings in the appendix of this manual if applicable for specific details on the two standard winch assemblies.



Attachment Fittings · **Anchor Locations**

Figure 10: Wood Plank Anchor Locations

- ◆ The following two pages lists three of the most common wall anchors. Before drilling a single hole you must verify the type of wall you will be installing against and then procure the necessary type and quantity of anchor to guarantee a successful installation. Immediately below is a table listing acceptable anchor types for given wall compositions.

Wall Type	Recommended Anchor
4" Pre-Cast	Rawl Powerstud Hilti Kwik Bolt 3
CMU (Hollow)	Tumble Toggle
CMU (Filled / Solid)	Double Expansion Shield Hilti Kwik Bolt 3

Figure 11: Recommended Anchors for Wall Types

Pre-Cast or Filled/Solid CMU

The Hilti Kwik bolt 3 comes in two varieties – Expansion anchor and Adhesive anchor (sometimes referred to as a chemical anchor). The Hilti Kwik Bolt 3 is the only anchor approved in many California districts due to its endurance under seismic loading. It has extremely high load capacities, but is has particularly stringent preparation steps. Consult Hilti’s own website (www.us.hilti.com) and installation instructions supplied with anchors for complete site and equipment preparations. Shown below are general steps for installation for reference only.

Hilti Kwik Bolt 3 [Expansion Anchor]

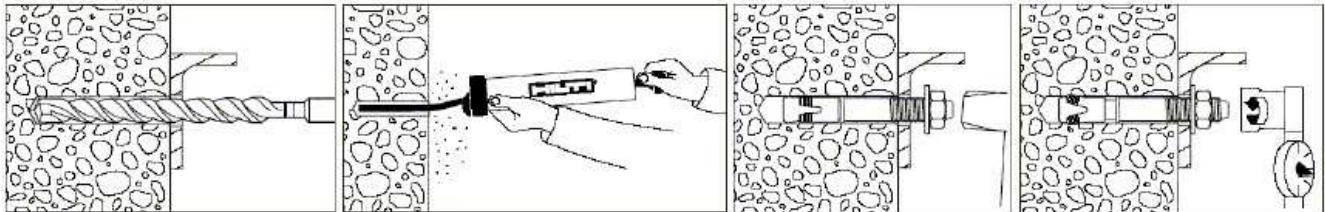

1. Hammer drill a hole to the same nominal diameter as the Kwik Bolt 3. The hole depth must exceed the anchor embedment by at least one diameter. The fixture or predrilled wood plank may be used as a template to ensure proper anchor location.
2. Clean hole.
3. Drive the Kwik Bolt 3 into the hole using a hammer. The anchor must be driven until at least six threads are below the surface of the fixture (or wood).
4. Tighten the nut to the recommended installation torque.

Wall Type	Recommended Torque
Normal and lightweight concrete	40 ft-lb
Grout filled block	25 ft-lb

Figure 12: Recommended Torque for Kwik Bolt 3 (Expansion Anchor)

Anchor Installation is Allowed in all Non-Shaded Areas

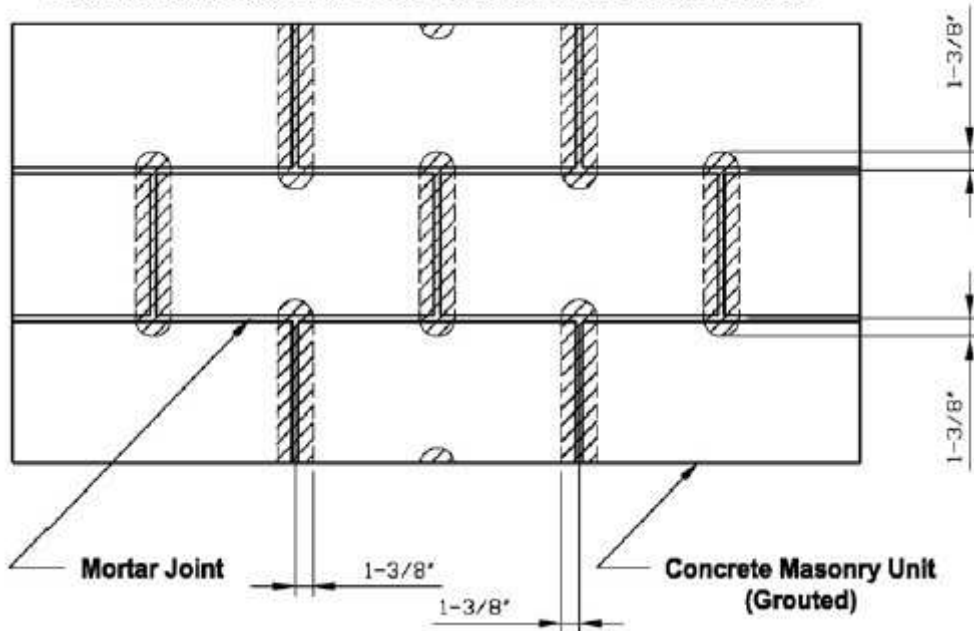
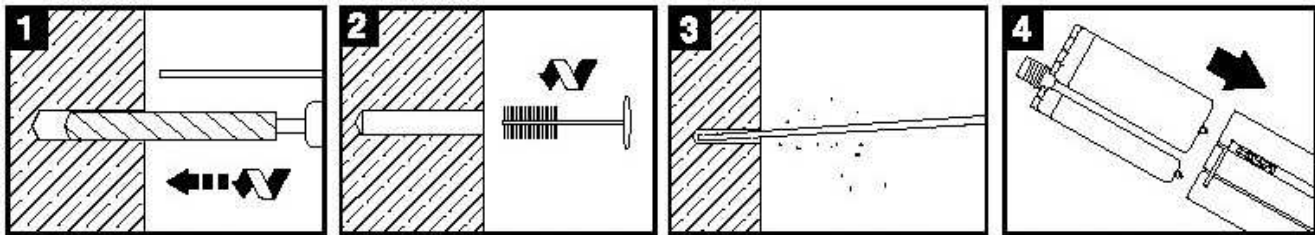
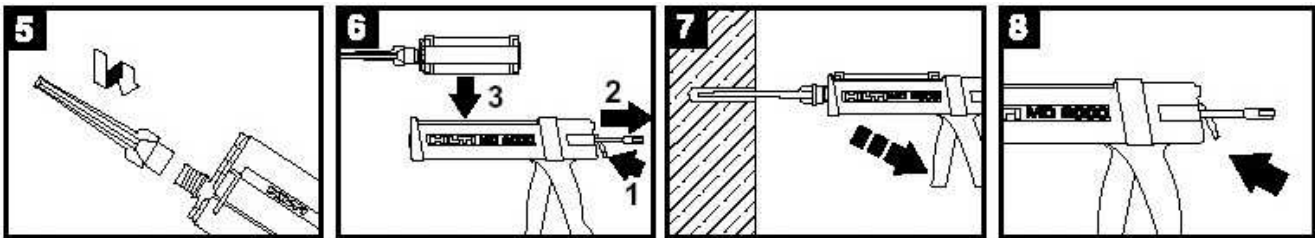

Figure 13: Allowed Anchor Locations for Concrete Masonry Unit (CMU)

Hilti Kwik Bolt 3 [HIT HY 150 Adhesive Anchor System]



1. Drill anchor hole with carbide bit. Contact Hilti for use of Diamond Core bits.
2. Clean hole with wire brush. Proper hole cleaning is essential.
3. Insert air nozzle to bottom of hole and blow out hole using a pump or compressed air.
4. Put refill pack into holder. Remove cap covering threaded projection.



5. Screw on static mixer.
6. Put holder/cartridge into appropriate dispenser and **discard first two trigger pulls of adhesive from each refill pack or cartridge.**
7. Inject adhesive into hole starting at the bottom until 1/3 to 2/3 full. Use mixer filler tube extensions when needed to reach the hole bottom.
8. Unlock dispenser.

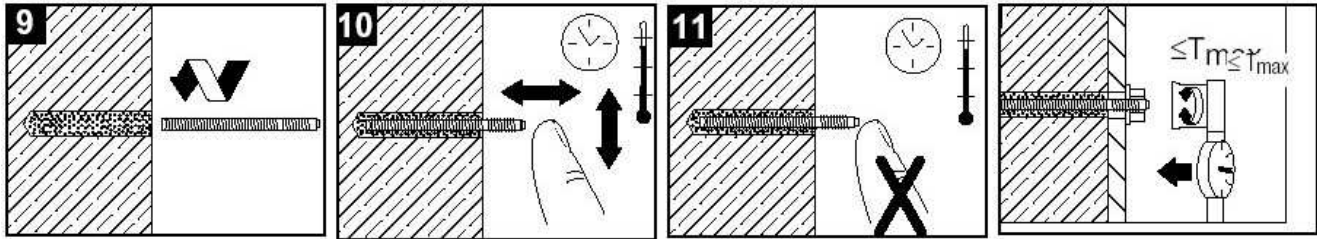

9. Insert rod. Twist during installation.
10. Fastener may be adjusted during specified gel time.
11. Do not disturb anchor between specified gel time and cure time.
12. Apply specified torque as required to secure items to be fastened. Do not exceed maximum torque specified.

See applicable Hilti Kwik Bolt tables below for gel and cure time information. Remember to consult Hilti directly for complete specifications and installation instructions. The information included herein is intended as a guide only for assistance in proper anchor selection. HAS rod information shown but other acceptable anchors are available from Hilti.

Open Gel Time Table (Approximate)¹

Base Material Temperature		HIT HY 150 ²	HIT-ICE
°F	°C		
-10	-23	-	1.5 hrs
0	-18	-	1.5 hrs
23	-5	25 min	40 min
32	0	18 min	26 min
41	5	13 min	11 min
68	20	5 min	4 min
86	30	4 min	1.5 min
104	40	2 min	-

¹ Product temperatures must be maintained above 41°F (5°C), with the exception of HIT-ICE which must be above 0°F (-18°C).

Final Cure Time Table (Approximate)¹

Base Material Temperature		HIT HY 150 ²	HIT-ICE
°F	°C		
-10	-23	-	24 hrs
0	-18	-	24 hrs
23	-5	6 hrs	6 hrs
32	0	3 hrs	4 hrs
41	5	90 min	2 hrs
68	20	50 min	1 hrs
86	30	40 min	30 min
104	40	30 min	-

² Use of HIT HY 150 and HIT-TZ rods must be installed in base material temperatures $\geq 40^\circ\text{F}$ (5°C).

Figure 14: Gel and Cure Times for Kwik Bolt 3 (Adhesive Anchor)

Jaypro mandates a minimum of 1/2" diameter anchors. Information supplied here is limited to that size anchor. See Hilti's website or call Hilti directly for information on other size anchors.

Visit Hilti Online 
www.us.hilti.com US
www.ca.hilti.com Canada



Hilti, Inc. (US) 1-800-879-8000
Hilti (Canada) Corporation 1-800-363-4458

Hollow Wall – Non-Filled CMU

No. 1 Type Tumble Toggle

The No. 1 tumble toggle features a tilting type toggle head, which is riveted to a flattened end screw. This design permits either pre-installing the fastener to the fixture or into the hole. Also it is the strongest hollow wall anchor.

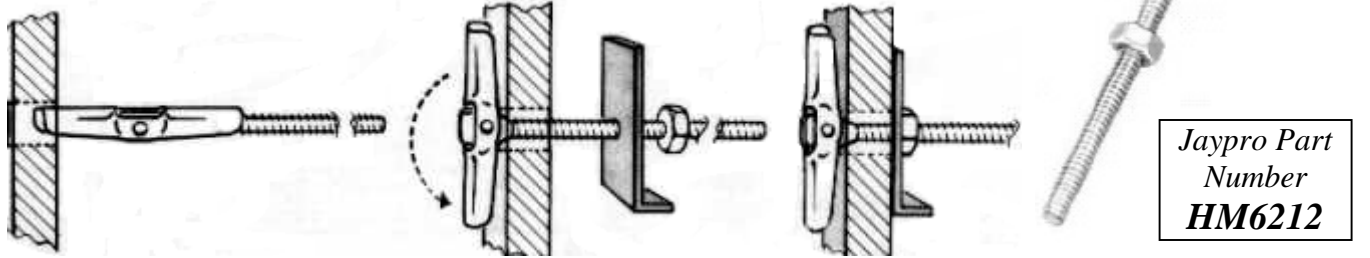

13. Turn wing to position parallel to bolt and insert through hole drilled in wall.
14. Wing flips to vertical by gravity. Remove nut and place bracket over hole.
15. Replace and tighten nut. Bracket is now held in place.

Installer Note: Only a 1/2" (1/2-13 x 6") diameter bolt type recommended, requiring a 7/8" diameter hole to be drilled. For availability, please contact Jaypro Sports New Construction Customer Service.

Solid Wall – Pre-Cast Concrete, Brick, or Filled Block

1/2" "Double" Dual Expansion Machine Bolt Anchor

The double is a dual expansion machine bolt anchor particularly suited for materials of questionable strength. It can be used in solid concrete, block, brick and stone. It consists of twin tubular sleeves, bound together with high tension spring steel bands which contains two protruding wedge shaped hollow cones. One cone is smooth, while the other is threaded. Internal lugs on the tapered ends of the hollow cones prevent them from rotating during anchor expansion. As the anchor is tightened, the opposing wedges at either end are drawn in tightly providing full length, 360° expansion over a large bearing area. For maximum expansion, the upper cone should protrude slightly before setting.

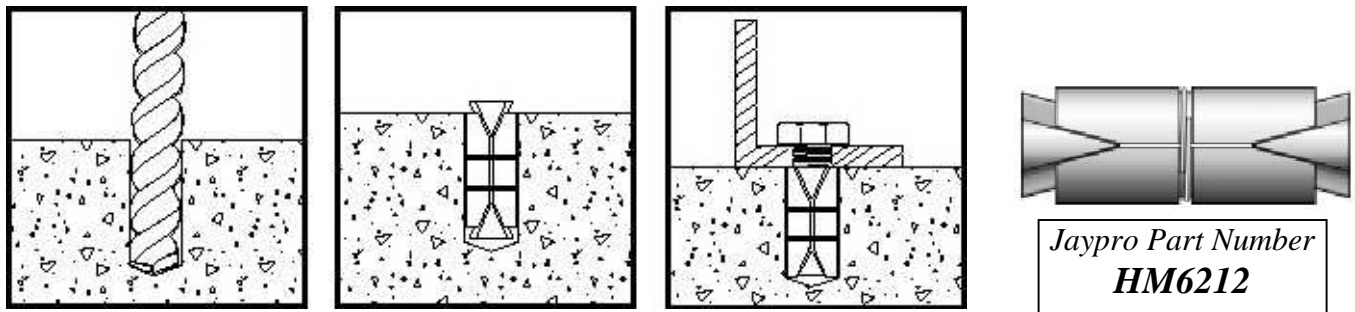

1. Drill hole of recommended diameter (7/8" for a 1/2" bolt) into the base material to a depth equal to, or slightly deeper than the length of the expansion anchor. Clean out the hole of all dust and cuttings.
2. Place the Double Expansion anchor, nut end first, into the hole. The top end of the anchor should be flush or slightly below the base material surface.
3. Place the object to be fastened over the anchor in the base material and bolt in to place.

Installer Note: Only 1/2" bolts are recommended for use by Jaypro. For availability, please contact Jaypro Sports New Construction Customer Service.

Appendix B – Weight Tables

Below is a table of weights for all common wall mount models. Note that these are general weights and the actual loads applied to the building structure depend on the installation and various field conditions. Weights listed include 42” glass backboards (no height adjusters). If height adjusters are included in the install, weights must be increased by 135 lbs. If any other board besides glass is used, weight may be reduced (see Jaypro Catalog for comparison of backboard weights).

Wall composition must be approved for supporting the listed loads. Anchors must be capable of supporting the load and a 5:1 safety factor minimum is recommended (this means the anchor and wall should be capable of supporting 5 times the weight of the backstop). Additionally, to compensate for the sudden ‘shock’ loading the unit will see should anyone ever ‘slam dunk’ the ball and hold onto the rim momentarily, a 1000 lb ‘dynamic’ load should be added to the stated values below and taking into consideration for any safety factor or point load calculations.

Face of Bank										
2'	3'	4'	5'	6'	7'	8'	9'	10'	11'	12'
441	451	461	471	481	491	501	542	552	562	572

Figure 15: Wall Mount Weights (Lbs)

Appendix C – Equipment Maintenance

MAINTENANCE INSTRUCTIONS

Jaypro prides itself on manufacturing high quality, durable and safe equipment. It is very important however that certain maintenance be performed annually on all our basketball backstops to insure years of safe, trouble-free use. This work must be completed by a qualified installer or technician. If one is not available to you, Jaypro’s own field service team can be hired to do the work. See number below, as for a field service manager to schedule an on-site visit.

BEFORE THE START OF EVERY SEASON, YOU MUST:

- ◆ Visually inspect entire unit to make sure that no parts have slipped or moved. (NOTE: To do this quickly, look to see if any unpainted areas have become visible or if painted areas have become damaged.)
- ◆ Lubricate ALL moving parts except the winch if installed.
- ◆ Visually inspect all cables and pulleys for wear to insure that they move freely. If any frayed cable is noted, backstop should be left in playing position and cable immediately replaced.
- ◆ Check backboard for level and plumb. (NOTE: If backboard is not plumb, it is necessary to adjust brace for plumb.)
- ◆ Check goal for appropriate height and level.
- ◆ Inspect and tighten ALL nuts and bolts.

IF ANY PARTS ARE REQUIRED, PLEASE CALL JAYPRO DIRECT.

1-800-243-0533

www.jaypro.com