

Echelon II[®]



INDUSTRIAL ORNAMENTAL ALUMINUM FENCE

Echelon II's superior *strength and durability* is a result of combining top quality design components with a *maintenance-free, architectural grade finish*. This revolutionary fence system is comprised of aluminum posts, panels, and mounting brackets that are *easily installed along any terrain*.



PRIMARY APPLICATIONS

- ▶ ***Water Treatment & Storage***
- ▶ ***Public Housing Authorities***
- ▶ ***State Facilities***
- ▶ ***Stadiums & Event Centers***
- ▶ ***Schools & Universities***
- ▶ ***Municipal Facilities***
- ▶ ***Airports***
- ▶ ***Parks & Recreation***
- ▶ ***Hospitals***



AMERISTARFENCE.COM | 888-333-3422

ASSA ABLOY, the global leader in door opening solutions

AMERISTAR[®]

ASSA ABLOY

Echelon II[®]

INDUSTRIAL ORNAMENTAL ALUMINIUM FENCE

1"sq x .062" / .125" wall* PICKETS | 1.75" x 1.75" x (.070" side & top wall) ForeRunner™ RAILS
2.5"sq x .080" & 3"sq x .120" wall POSTS

* Invincible only

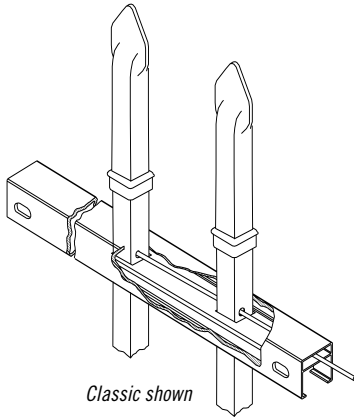

STYLE OPTIONS



FABRICATION & DESIGN

Ameristar crafted the ForeRunner rail to increase strength through architecture. The innovative design of the ForeRunner rail contains an internally secured rod that allows for variable pitch connection, high angle biasability and is easy to install. Internal security eliminates the need for visually unappealing external fasteners.



POWDERED COATED SUPERIOR FINISH

Echelon features a state of the art polyester powder coating system that provides a durable and scratch resistant finish. This eco-friendly process provides years of long-lasting durability and maintenance-free ownership.



LIFETIME LIMITED WARRANTY

The Echelon families of aluminum fencing products are manufactured from superior quality materials by skilled craftsmen with the highest standards of workmanship in the industry. Ameristar is confident in offering Echelon with a limited lifetime warranty, backed by over 30 years of demonstrated excellence in manufacturing of ornamental fence.



DOMESTIC MANUFACTURING

Ameristar is committed to providing products that are manufactured in the USA. We have made significant investments in technology, process improvement, and employee training in an effort to secure American jobs and combat inferior import products.



FENCE PRODUCTS

TO PLACE YOUR ORDER CALL 888-333-3422

VISIT AMERISTARFENCE.COM

ECHELON II® | 2, 3 & 4-RAIL OPTIONS | 4" AIR-SPACE

STANDARD BOTTOM OPTION AVAILABLE

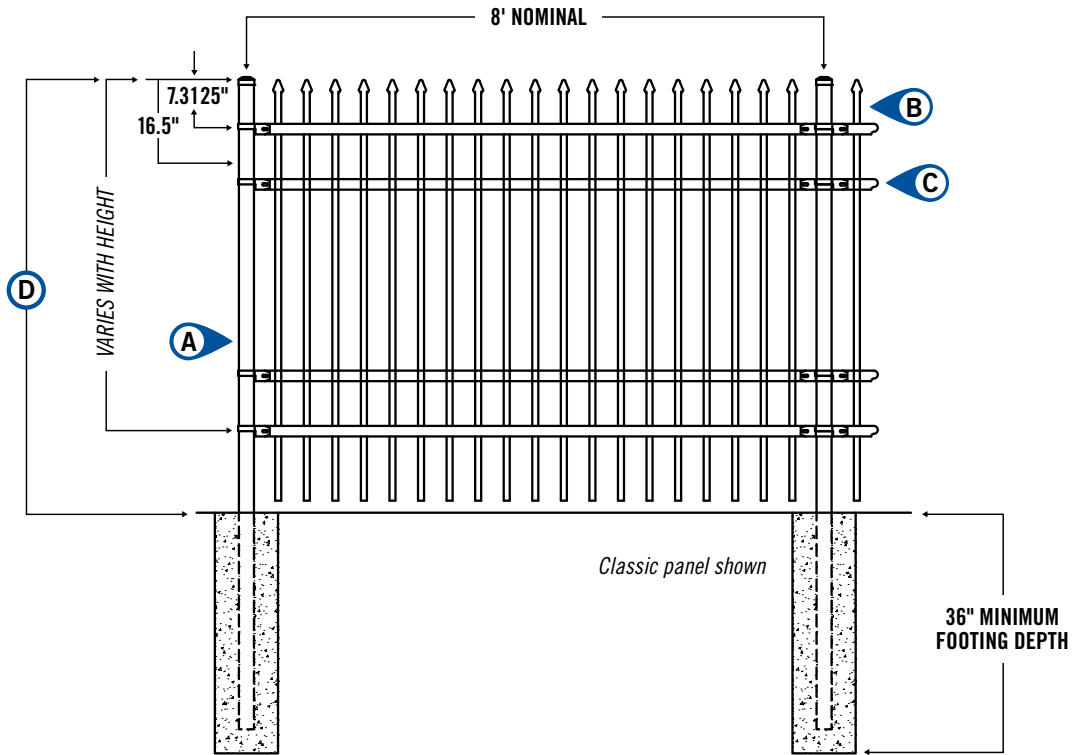

- Ⓐ 2.5"sq x .080" & 3"sq x .120 wall POSTS
- Ⓑ 1"sq x 0.062"wall PICKETS
- Ⓒ 1.75" x 1.75" (0.070" top & side walls) ForeRunner RAILS
- Ⓓ 4', 5', 6', 7', 8', 9' & 10' PANEL HEIGHTS

PANELS REQUIRE ASSEMBLY

Refer to construction specification & tables within this section for recommended post space by bracket type

Effective: 01/06/15

ECHELON II® | 2-RAIL PANELS | 8' PANEL LENGTH

STANDARD BOTTOM | 8' PANEL LENGTH (92.625" actual width) | 19 PICKETS PER PANEL | ASSEMBLY REQUIRED

PANEL	ITEM NUMBER	WEIGHT	STOCKING
4'	2A☒⊗20468	37 lbs	⊙
5'	2A☒⊗20588	42 lbs	⊙
6'	2A☒⊗20708	48 lbs	⊙

☒ = FENCE STYLES AVAILABLE | **C** = Classic **M** = Majestic **G** = Genesis
 ⊗ = COLOR OPTIONS AVAILABLE | **B** = Black **N** = Bronze **W** = White **S** = Sand
 ⊙ = NON-STOCKED PRODUCT
 For details, see Ameristar's Sales Policy in the catalog guide.

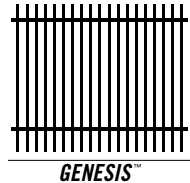
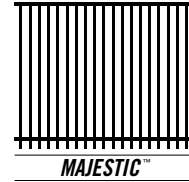
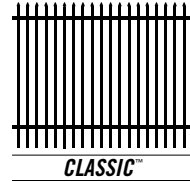

ECHELON II® | 2-RAIL PANELS | 6' PANEL LENGTH

STANDARD BOTTOM | 6' PANEL LENGTH (67.75" actual width) | 14 PICKETS PER PANEL | ASSEMBLY REQUIRED

PANEL	ITEM NUMBER	WEIGHT	STOCKING
4'	2A☒⊗20466	27 lbs	⊙
5'	2A☒⊗20586	30 lbs	⊙
6'	2A☒⊗20706	35 lbs	⊙

☒ = FENCE STYLES AVAILABLE | **C** = Classic **M** = Majestic **G** = Genesis
 ⊗ = COLOR OPTIONS AVAILABLE | **B** = Black **N** = Bronze **W** = White **S** = Sand
 ⊙ = NON-STOCKED PRODUCT
 For details, see Ameristar's Sales Policy in the catalog guide.

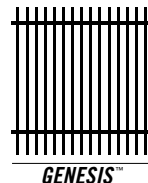
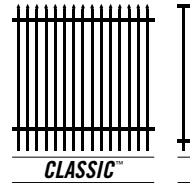

Effective: 01/06/15

ECHELON II® | 3-RAIL PANELS | 8' PANEL LENGTH

STANDARD BOTTOM | 8' PANEL LENGTH (92.625" / 91.25"† actual width) | 19 / 20† PICKETS PER PANEL | ASSEMBLY REQUIRED

PANEL	ITEM NUMBER	WEIGHT	STOCKING
4'	2A☒☒30468	44 lbs	☉
5'	2A☒☒30588	49 lbs	☉
6'	2A☒☒30708	55 lbs	☉
7'	2A☒☒30828†	60 / 94†	☉

☒ = FENCE STYLES AVAILABLE | C = Classic M = Majestic G = Genesis I = Invincible†

☒ = COLOR OPTIONS AVAILABLE | B = Black N = Bronze W = White S = Sand

☉ = NON-STOCKED PRODUCT

For details, see Ameristar's Sales Policy in the catalog guide.

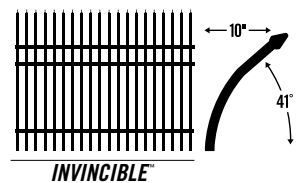
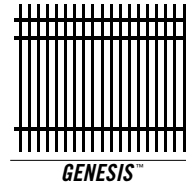
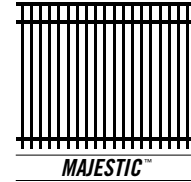
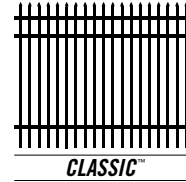

ECHELON II® | 3-RAIL PANELS | 6' PANEL LENGTH

STANDARD BOTTOM | 6' PANEL LENGTH (67.75" / 71.375"† actual width) | 14 / 15† PICKETS PER PANEL | ASSEMBLY REQUIRED

PANEL	ITEM NUMBER	WEIGHT	STOCKING
4'	2A☒☒30466	32	☉
5'	2A☒☒30586	36	☉
6'	2A☒☒30706	41	☉
7'	2A☒☒30826†	44 / 69†	☉

☒ = FENCE STYLES AVAILABLE | C = Classic M = Majestic G = Genesis I = Invincible†

☒ = COLOR OPTIONS AVAILABLE | B = Black N = Bronze W = White S = Sand

☉ = NON-STOCKED PRODUCT

For details, see Ameristar's Sales Policy in the catalog guide.

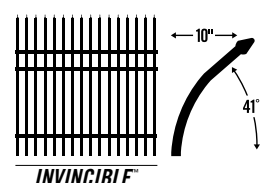
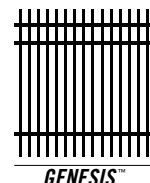
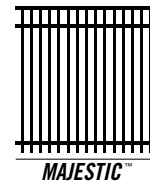
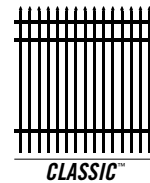

Effective: 01/06/15

ECHELON II® | 4-RAIL PANELS | 8' PANEL LENGTH

STANDARD BOTTOM | 8' PANEL LENGTH (92.625" / 91.25"† actual width) | 19 / 20† PICKETS PER PANEL | ASSEMBLY REQUIRED

PANEL	ITEM NUMBER	WEIGHT	STOCKING
8'	2A☒Ⓞ40948†	73 / 111†	⊖
9'	2A☒Ⓞ41068†	78 / 121†	⊖
10'	2A☒Ⓞ41188†	84 / 131†	⊖

☒ = FENCE STYLES AVAILABLE | C = Classic M = Majestic G = Genesis I = Invincible†

Ⓞ = COLOR OPTIONS AVAILABLE | B = Black N = Bronze W = White S = Sand

⊖ = NON-STOCKED PRODUCT

For details, see Ameristar's Sales Policy in the catalog guide.

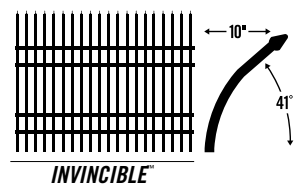
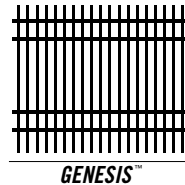
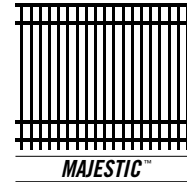
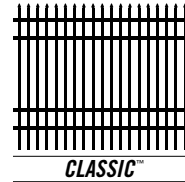

Effective: 01/06/15

ECHELON II® | 4-RAIL PANELS | 6' PANEL LENGTH

STANDARD BOTTOM | 6' PANEL LENGTH (67.75" / 71.375"† actual width) | 14 / 15† PICKETS PER PANEL | ASSEMBLY REQUIRED

PANEL	ITEM NUMBER	WEIGHT	STOCKING
8'	2A☒⊗40946†	54 / 82†	☉
9'	2A☒⊗41066†	57 / 89†	☉
10'	2A☒⊗41186†	62 / 97†	☉

☒ = FENCE STYLES AVAILABLE | C = Classic M = Majestic G = Genesis I = Invincible†

⊗ = COLOR OPTIONS AVAILABLE | B = Black N = Bronze W = White S = Sand

☉ = NON-STOCKED PRODUCT

For details, see Ameristar's Sales Policy in the catalog guide.

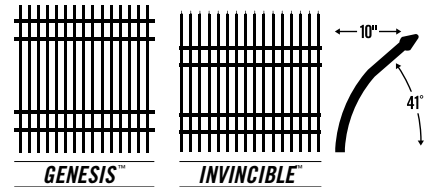
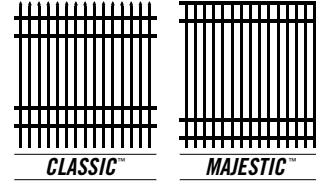

Effective: 01/06/15

ECHELON II® | 3-RAIL PANELS WITH RINGS | 8' PANEL LENGTH

STANDARD BOTTOM | 8' PANEL LENGTH (92.625" actual width) | 19 PICKETS PER PANEL | ASSEMBLY REQUIRED

PANEL	ITEM NUMBER	WEIGHT	STOCKING
4'	2A☒☉30468R	50 lbs	☉
5'	2A☒☉30588R	55 lbs	☉
6'	2A☒☉30708R	61 lbs	☉
7'	2A☒☉30828R	66 lbs	☉

☒ = FENCE STYLES AVAILABLE | **C** = Classic **M** = Majestic **G** = Genesis

☉ = COLOR OPTIONS AVAILABLE | **B** = Black **N** = Bronze **W** = White **S** = Sand

☉ = NON-STOCKED PRODUCT

For details, see Ameristar's Sales Policy in the catalog guide.

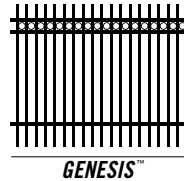
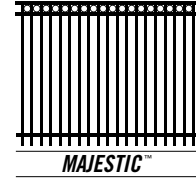
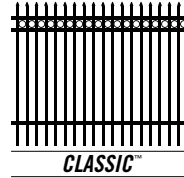

ECHELON II® | 3-RAIL PANELS WITH RINGS | 6' PANEL LENGTH

STANDARD BOTTOM | 6' PANEL LENGTH (67.75" actual width) | 14 PICKETS PER PANEL | ASSEMBLY REQUIRED

PANEL	ITEM NUMBER	WEIGHT	STOCKING
4'	2A☒☉30466R	36 lbs	☉
5'	2A☒☉30586R	40 lbs	☉
6'	2A☒☉30706R	45 lbs	☉
7'	2A☒☉30826R	48 lbs	☉

☒ = FENCE STYLES AVAILABLE | **C** = Classic **M** = Majestic **G** = Genesis

☉ = COLOR OPTIONS AVAILABLE | **B** = Black **N** = Bronze **W** = White **S** = Sand

☉ = NON-STOCKED PRODUCT

For details, see Ameristar's Sales Policy in the catalog guide.

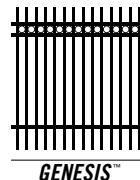
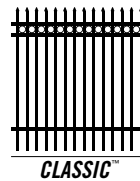

Effective: 01/06/15

ECHELON II® | 4-RAIL PANELS WITH RINGS | 8' PANEL LENGTH

STANDARD BOTTOM | 8' PANEL LENGTH (92.625" actual width) | 19 PICKETS PER PANEL | ASSEMBLY REQUIRED

PANEL	ITEM NUMBER	WEIGHT	STOCKING
8'	2A☒☉40948R	79 lbs	☉
9'	2A☒☉41068R	84 lbs	☉
10'	2A☒☉41188R	90 lbs	☉

☒ = FENCE STYLES AVAILABLE | **C** = Classic **M** = Majestic **G** = Genesis

☉ = COLOR OPTIONS AVAILABLE | **B** = Black **N** = Bronze **W** = White **S** = Sand

☉ = NON-STOCKED PRODUCT

For details, see Ameristar's Sales Policy in the catalog guide.

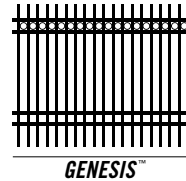
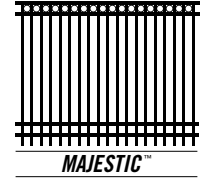
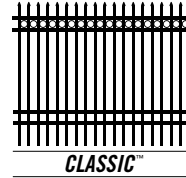

ECHELON II® | 4-RAIL PANELS WITH RINGS | 6' PANEL LENGTH

STANDARD BOTTOM | 6' PANEL LENGTH (67.75" actual width) | 14 PICKETS PER PANEL | ASSEMBLY REQUIRED

PANEL	ITEM NUMBER	WEIGHT	STOCKING
8'	2A☒☉40946R	58 lbs	☉
9'	2A☒☉41066R	61 lbs	☉
10'	2A☒☉41186R	66 lbs	☉

☒ = FENCE STYLES AVAILABLE | **C** = Classic **M** = Majestic **G** = Genesis

☉ = COLOR OPTIONS AVAILABLE | **B** = Black **N** = Bronze **W** = White **S** = Sand

☉ = NON-STOCKED PRODUCT

For details, see Ameristar's Sales Policy in the catalog guide.

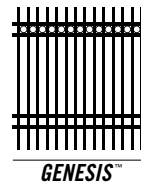
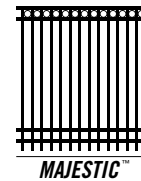
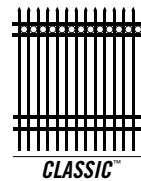

Effective: 01/06/15

ECHELON II® | ADORNMENTS, BRACKETS & PANEL ACCESSORIES

AVAILABLE IN BAG QTY

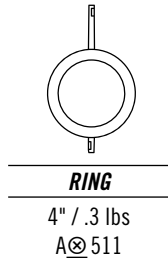
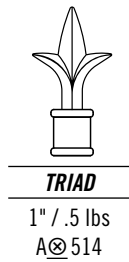

1" PRESS FIT PICKET FINIALS

» 19 finials required per 8' panel

⊗ = COLOR OPTIONS AVAILABLE | **B** = Black **N** = Bronze
W = White **S** = Sand

NOTE: Picket plugs are available in bag quantities only / 20 plugs per bag
Item number: 8450P-20 = **B** / 8453P = **W**

ECHELON II PANEL ADORNMENTS

» 18 per box quantity

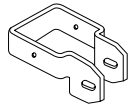

DESCRIPTION	SIZE	ITEM NUMBER	BAG QTY	BOX QTY	WEIGHT
Boulevard Bracket	2.5"	B⊗ 302S	2	40	.46 lbs
	3"	B⊗ 303S	2	40	.53 lbs

Bags packaged with: #14 x .75" self-drilling screws | .25" x 2" carriage bolts | .25" tee nuts

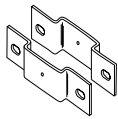

Invincible Line Bracket	2.5"	B⊗ 319	2	24	1.2 lbs
	3"	B⊗ 320	2	24	1.2 lbs

Bags packaged with: #14 x .75" self-drilling screws | .25" x 2" one-way bolts | .25" tee nuts

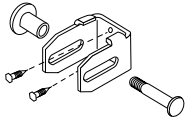

Flat Mount Bracket	2"	B⊗ 301S	2	50	.42 lbs
--------------------	----	---------	---	----	---------

Bags packaged with: #14 x .75" self-drilling screws | .25" x 2" carriage bolts | .25" tee nuts

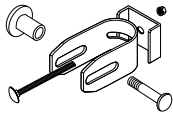

Swivel Bracket	N/A	B⊗ 304S	2	40	1 lbs
----------------	-----	---------	---	----	-------

This bracket increases post spacing. Fasteners included.

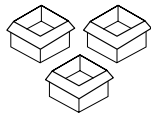

Grommet Sets	1" sq.	X⊗ 150P	15	n/a	3 oz
	1" sq.	X⊗ 190P	19	n/a	3 oz

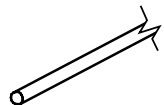

Retaining Rod	67"	H531P	1	1	.2 lbs
	71.375"	H532P	1	1	2.2 lbs
	91.25"	H533P	1	1	.3 lbs
	92.625"	H530P	1	1	3.2 lbs

Galvanized rod / .125" diameter

⊗ = COLOR OPTIONS AVAILABLE | **B** = Black **N** = Bronze **W** = White **S** = Sand

Effective: 01/06/15

ECHELON II® | RAILS

RAILS IN BOX QTY ONLY

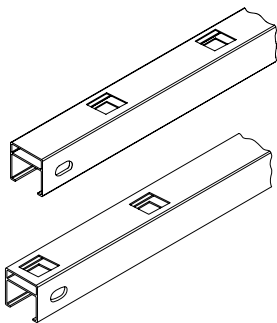

DESCRIPTION	PANEL WIDTH	LENGTH	ITEM NUMBER	BOX QTY	WEIGHT
ForeRunner Rail / Through Punched	8'	92.625"	AC⊗R28R*	4	4.4 lbs
	6'	67.75"	AC⊗R26R*	6	3.2 lbs
	8'	91.25"	AI⊗R28R†	4	4.3 lbs
	6'	71.375"	AI⊗R26R†	6	3.42 lbs

* Used for Classic & Genesis styles (for Majestic rails excluding top rail). Includes grommets & retaining rods.

† Used for Invincible style panel . Includes grommets & retaining rods.

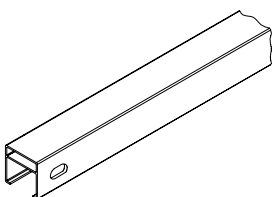

ForeRunner Rail / Bottom Punched	8'	92.625"	AM⊗R28R	4	4.4 lbs
	6'	67.75"	AM⊗R26R	6	3.2 lbs

Used as top rails on Majestic style panels. Includes retaining rods..

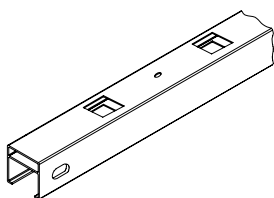

ForeRunner Rail / Through Punched FOR RINGS	8'	92.625"	AR⊗R28R*	4	4.4 lbs
	6'	67.75"	AR⊗R26R*	6	3.2 lbs
	8'	92.625"	ACR⊗R28R‡	4	4.4 lbs
	6'	67.75"	ACR⊗R26R‡	6	3.2 lbs

* Used as second rail on all panels with rings. Includes grommets & retaining rods.

‡ Used as top rail on Classic & Genesis panels with rings. Includes grommets & retaining rods.

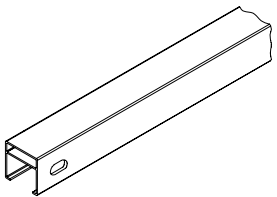

ForeRunner Rail / Bottom Punched FOR RINGS	8'	92.625"	AMR⊗R28R*	4	4.4 lbs
	6'	67.75"	AMR⊗R26R°	6	3.2 lbs

* Used as top rail for Majestic panels with rings. Includes grommets & retaining rods.





° Used as top rail for Majestic panels with rings. Includes grommets & retaining rods.

⊗ = COLOR OPTIONS AVAILABLE | B = Black N = Bronze W = White S = Sand

Effective: 01/06/15

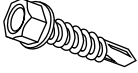
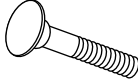
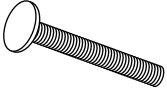
ECHELON II® | FASTENERS

AVAILABLE IN BOX QTY

DESCRIPTION	ITEM NUMBER	BAG QTY	WEIGHT
 #14 x .75" Self-Drilling Screws	1-0004- <u>⊗</u> P-50	50	.6 lbs
<i>Steel hex head self-drilling screws for industrial brackets</i>			
 .25" x 2" One-Way Bolts	7150 <u>⊗</u> P-20	20	.8 lbs
<i>Steel carriage bolt for industrial brackets</i>			
 .3125" x 4" Carriage Bolts	H <u>⊗</u> 302P	1	.082 lbs
 .3125" x 3.5" Carriage Bolts	2-0006- <u>⊗</u> P	1	.09 lbs
 .3125" Flange Nuts	H <u>⊗</u> 300P	1	.013 lbs
 .25" Tee Nuts	7157 <u>⊗</u> P-20	20	.3 lbs
 Fastener Socket	8865PFG	1	.06 lbs
<i>Tamper-proof fasteners require socket for installation</i>			

⊗ = COLOR OPTIONS AVAILABLE | **B** = Black **N** = Bronze **W** = White **S** = Sand

⊗ = COLOR OPTIONS AVAILABLE | **1** = Black **2** = Bronze **3** = Sand **4** = White

ECHELON II® | CUSTOM FINISHES

WARRANTY ON CUT COMPONENTS VOID WITHOUT PROPER TOUCH-UP APPLICATION*

*For details & the guidelines for the proper 3-step process, see Ameristar's Sales Policy in the catalog guide

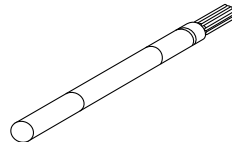

PAINT PEN

.5 lbs / P⊗100

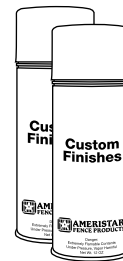

SPRAY PAINT

1.1 lbs / F⊗100

⊗ = COLOR OPTIONS AVAILABLE | **B** = Black **N** = Bronze **W** = White **S** = Sand

Effective: 01/06/15

ECHELON II® | ALUMINUM SQUARE POSTS

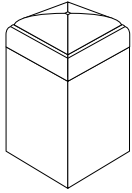

ALUMINUM POSTS

	POST LENGTH	ITEM NUMBER	WEIGHT
2.5"sq. x .080 wall	6'	2APⓧ25072	7 lbs
	7'	2APⓧ25084	8 lbs
	8'	2APⓧ25096	9 lbs
	9'	2APⓧ25108	11 lbs
	10'	2APⓧ25120	12 lbs
	11'	2APⓧ25132	13 lbs
3"sq. x .125 wall	12'	2APⓧ25144	15 lbs
	7'	APⓧ30084	12 lbs
	8'	APⓧ30096	14 lbs
	9'	APⓧ30108	15 lbs
	10'	APⓧ30120	17 lbs
	11'	APⓧ30132	18 lbs
4"sq. x .250 wall	12'	APⓧ30144	20 lbs
	7'	APⓧ40084	31 lbs
	8'	APⓧ40096	36 lbs
	9'	APⓧ40108	40 lbs
	10'	APⓧ40120	43 lbs
	11'	APⓧ40132	49 lbs
	12'	APⓧ40144	54 lbs
	13'	APⓧ40156	58 lbs

ⓧ = COLOR OPTIONS AVAILABLE | **B** = Black **N** = Bronze
W = White **S** = Sand

Effective: 01/06/15

ECHELON II® | STEEL SQUARE POSTS

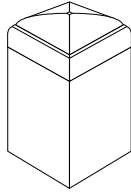

STEEL POSTS

POST LENGTH	ITEM NUMBER	WEIGHT		
3"sq. x 12 ga.	5'	P⊗30060	20 lbs	
	6'	P⊗30072	24 lbs	
	7'	P⊗30084	30 lbs	
	8'	P⊗30096	34 lbs	
	9'	P⊗30108	39 lbs	
	10'	P⊗30120	43 lbs	
	11'	P⊗30132	47 lbs	
	12'	P⊗30144	51 lbs	
	13'	P⊗30156	56 lbs	
	14'	P⊗30168	60 lbs	
	15'	P⊗30180	64 lbs	
	16'	P⊗30192	69 lbs	
	4"sq. x 11 ga.	6'	P⊗40072	39 lbs
		7'	P⊗40084	47 lbs
		8'	P⊗40096	54 lbs
		9'	P⊗40108	61 lbs
10'		P⊗40120	67 lbs	
11'		P⊗40132	74 lbs	
12'		P⊗40144	81 lbs	
13'		P⊗40156	87 lbs	
14'		P⊗40168	94 lbs	
15'		P⊗40180	101 lbs	
6"sq. x .1875 wall	7'	P⊗60084	102 lbs	
	8'	P⊗60096	116 lbs	
	9'	P⊗60108	131 lbs	
	10'	P⊗60120	145 lbs	
	11'	P⊗60132	160 lbs	
	12'	P⊗60144	174 lbs	
	13'	P⊗60156	189 lbs	
	14'	P⊗60168	203 lbs	
	15'	P⊗60180	218 lbs	
	16'	P⊗60192	232 lbs	

⊗ = COLOR OPTIONS AVAILABLE | **B** = Black **N** = Bronze
W = White **S** = Sand

Effective: 01/06/15

ECHELON II® | STEEL PLATED SQUARE POSTS

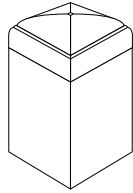

STEEL POSTS

	POST LENGTH	PLATE SIZE	ITEM NUMBER	WEIGHT
3"sq. x 12ga.	4'	6" sq. x .25" / .5625" holes (5003G)	P⊗30048P	20 lbs
	5'	6" sq. x .25" / .5625" holes (5003G)	P⊗30060P	24 lbs
	6'	6" sq. x .25" / .5625" holes (5003G)	P⊗30072P	30 lbs
	7'	6" sq. x .25" / .5625" holes (5003G)	P⊗30084P	34 lbs
	8'	6" sq. x .25" / .5625" holes (5003G)	P⊗30096P	39 lbs
	9'	6" sq. x .25" / .5625" holes (5003G)	P⊗30108P	43 lbs
4"sq. x 11ga.	10'	6" sq. x .25" / .5625" holes (5003G)	P⊗30120P	47 lbs
	4'	8" sq. x .375" / .5625" holes (8876G)	P⊗40048P	33 lbs
	5'	8" sq. x .375" / .5625" holes (8876G)	P⊗40060P	39 lbs
	6'	8" sq. x .375" / .5625" holes (8876G)	P⊗40072P	47 lbs
	7'	8" sq. x .375" / .5625" holes (8876G)	P⊗40084P	54 lbs
	8'	8" sq. x .375" / .5625" holes (8876G)	P⊗40096P	61 lbs
9'	8" sq. x .375" / .5625" holes (8876G)	P⊗40108P	67 lbs	
10'	8" sq. x .375" / .5625" holes (8876G)	P⊗40120P	74 lbs	

⊗ = COLOR OPTIONS AVAILABLE | **B** = Black **N** = Bronze **W** = White **S** = Sand

NOTE: Plated posts used with Majestic may require an additional 1" longer than the panel or gate height, depending on the grade elevation.

ECHELON II® | POST CAPS

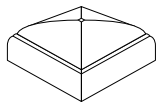

STANDARD FLAT CAP

Steel

CAP SIZE	ITEM NUMBER	WEIGHT
3"sq.	A⊗ 508	0.3 lbs
4"sq.	A⊗ 509	0.4 lbs
6"sq.	A⊗ 515	0.8 lbs

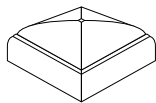

STANDARD FLAT CAP

Aluminum

CAP SIZE	ITEM NUMBER	WEIGHT
2.5"sq.	A⊗ 600P	0.2 lbs
3"sq.	A⊗ 700P	0.3 lbs
4"sq.	A⊗ 800P	0.4 lbs



BALL CAP

Aluminum

BASE SIZE	ITEM NUMBER	WEIGHT
2.5"sq.	A⊗ 513	.75 lbs
3"sq.	A⊗ 516	.8 lbs
4"sq.	A⊗ 517	2 lbs
6"sq.	A⊗ 521	8 lbs

Effective: 01/06/15

ECHELON II® | CONSTRUCTION SPECIFICATION 32 31 19

HEAVY INDUSTRIAL ALUMINUM ORNAMENTAL FENCE SYSTEM – INTERNALLY SECURED

PART 1 - GENERAL

1.01 WORK INCLUDED

The contractor shall provide all labor, materials and appurtenances necessary for installation of the industrial ornamental aluminum fence system defined herein at (*specify project site*).

1.02 RELATED WORK

Section ___ - Earthwork

Section ___ - Concrete

1.03 SYSTEM DESCRIPTION

The manufacturer shall supply a total industrial ornamental aluminum fence system of the Ameristar® Echelon II® (*specify Classic™, Majestic™, Genesis™ or Invincible™*) design. The system shall include all components (*i.e., pickets, rails, posts, gates and hardware*) required.

1.04 QUALITY ASSURANCE

The contractor shall provide laborers and supervisors who are thoroughly familiar with the type of construction involved and materials and techniques specified.

1.05 REFERENCES

- **ASTM B117** – Practice for Operating Salt-Spray (*Fog*) Apparatus
- **ASTM B221** – Standard Specification for Aluminum and Aluminum-Alloy Extruded Bars, Rods, Wire, Profiles and Tubes
- **ASTM D523** – Test Method for Specular Gloss
- **ASTM D822** – Practice for Conducting Tests on Paint and Related Coatings and Materials using Filtered Open-Flame Carbon-Arc Light and Water Exposure Apparatus
- **ASTM D1654** – Test Method for Evaluation of Painted or Coated Specimens Subjected to Corrosive Environments
- **ASTM D2244** – Test Method for Calculation of Color Differences from Instrumentally Measured Color Coordinates
- **ASTM D2794** – Test Method for Resistance of Organic Coatings to the Effects of Rapid Deformation (Impact)
- **ASTM D3359** – Test Method for Measuring Adhesion by Tape Test

1.06 SUBMITTAL

The manufacturer's submittal package shall be provided prior to installation.

1.07 PRODUCT HANDLING AND STORAGE

Upon receipt at the job site, all materials shall be checked to ensure that no damage occurred during shipping or handling. Materials shall be stored in such a manner to ensure proper ventilation and drainage, and to protect against damage, weather, vandalism and theft.

PART 2 - MATERIALS

2.01 MANUFACTURER

The industrial ornamental aluminum fence system shall conform to Ameristar Echelon II, (*specify Classic, Majestic, Genesis or Invincible*) (*specify 2-Rail, 3-Rail, 4-Rail, 3-rail with rings, or 4-rail with rings*) style manufactured by Ameristar Fence Products, Inc., in Tulsa, Oklahoma.

2.02 MATERIAL

- A. Aluminum material for fence framework (*i.e., tubular pickets, rails and posts*) shall conform to the requirements of **ASTM B221**. The aluminum extrusions for posts and rails shall be Alloy and Temper Designation **6005-T52**. The aluminum extrusions for pickets shall be Alloy and Temper Designation **6063-T52**.
- B. The manufactured framework shall be subjected to the Ameristar thermal stratification coating process (*high-temperature, in-line, multi-stage, and multi-layer*) including, as a minimum, a six-stage pretreatment/wash and an electrostatic spray application of a polyester finish. The topcoat shall be a "no-mar" TGIC polyester powder coat finish with a minimum thickness of 2 mils (0.0508mm). The color shall be (*specify Black, Bronze, White, or Desert Sand*). The stratification-coated framework shall be capable of meeting the performance requirements for each quality characteristic shown in **Table 2**.
- C. Material for fence pickets shall be 1" square x 0.062" thick extruded tubing. The cross-sectional shape of the rails shall conform to the manufacturer's ForeRunner™ design with outside cross-section dimensions of 1.75" square. The top wall and internal web of the rail shall be 0.070" thick; the sidewalls shall be 0.070" thick for superior vertical load strength. Picket holes in the ForeRunner rail shall be spaced 4.715" o.c., except for Invincible style 6' long, which shall be, spaced 4.98" o.c. Picket retaining rods shall be 0.125" diameter galvanized steel. Fence posts and gate posts shall meet the minimum size requirements of **Table 1**. High quality PVC grommets shall be supplied to seal all picket-to-rail intersections.
- D. All fasteners shall be stainless steel. Bracket to rail attachments shall be made using specially designed one-way tamperproof security bolts with inverted "t-nuts". Bracket to post connections shall be made using self-drilling hex-head screws.
- E. Aluminum castings shall be used for all rings, post caps, finials, and miscellaneous adornments.

Effective: 01/06/15

ECHELON II® | CONSTRUCTION SPECIFICATION 32 31 19

HEAVY INDUSTRIAL ALUMINUM ORNAMENTAL FENCE SYSTEM – INTERNALLY SECURED

2.03 FABRICATION

- A. Pickets, rails and posts shall be pre-cut to specified lengths. ForeRunner rails shall be pre-punched to accept pickets.
- B. The rail inner web shall form a single extruded rail with outer channel to form the raceway for the internal retaining rod. Grommets shall be inserted into the pre-punched holes in the rails, and pickets shall be inserted through the grommets so that pre-drilled picket holes align with the internal raceway of the two-part ForeRunner rails. *(Note: This can best be accomplished by using an alignment template).* Retaining rods shall be inserted into each ForeRunner rail so that they pass through the pre-drilled holes in each picket, thus completing the panel assembly.
- C. Completed panels shall be capable of supporting a 300 lb. load *(applied at midspan)* without permanent deformation. Panels shall be biasable to a 25% change in grade.
- D. Gates shall be fabricated using 1.75" sq. reinforced ForeRunner rail material, 2" sq. x .250" gate ends, and 1" sq. x .125" pickets. All rail and upright intersections shall be joined by welding. All picket and rail intersections shall be joined by welding.

PART 3 - EXECUTION

3.01 PREPARATION

All new installation shall be laid out by the contractor in accordance with the construction plans.

3.02 FENCE INSTALLATION

Fence post shall be spaced according to **Table 3**, plus or minus ½". For installations that must be raked to follow sloping grades, the post spacing dimension must be measured along the grade. Fence panels shall be attached to posts with brackets supplied by the manufacturer. Posts shall be set in concrete footers having a minimum depth of 36" *(Note: In some cases, local restrictions of freezing weather conditions may require a greater depth).* The "Earthwork" and "Concrete" sections of this specification shall govern material requirements for the concrete footer. Posts setting by other methods such as plated posts or grouted core-drilled footers are permissible only if shown by engineering analysis to be sufficient in strength for the intended application.

3.03 FENCE INSTALLATION MAINTENANCE

When cutting/drilling rails or posts adhere to the following steps to seal the exposed surfaces; 1) Remove all metal shavings from cut area. 2) Apply custom finish paint matching fence color. Failure to seal exposed surfaces per steps 1 & 2 above will negate warranty. Ameristar spray cans or paint pens shall be used to prime and finish exposed surfaces; it is recommended that paint pens be used to prevent overspray. Use of non-Ameristar parts or components will negate the manufactures' warranty.

3.04 GATE INSTALLATION

Gate posts shall be spaced according to the manufacturers' gate drawings, dependent on standard out-to-out gate leaf dimensions and gate hardware selected. Type and quantity of gate hinges shall be based on the application; weight, height, and number of gate cycles. The manufacturers' gate drawings shall identify the necessary gate hardware required for the application. Gate hardware shall be provided by the manufacture of the gate and shall be installed per manufacturer's recommendations.

3.05 CLEANING

The contractor shall clean the jobsite of excess materials; post-hole excavations shall be scattered uniformly away from posts.

SEE REFERENCED TABLES ON THE FOLLOWING PAGE 

Effective: 01/06/15

ECHELON II® | CONSTRUCTION SPECIFICATION 32 31 19

TABLE 1

MINIMUM SIZES FOR ECHELON II POSTS				
FENCE POSTS		PANEL HEIGHTS		
2½" x 2½" x .080" aluminum w/ reinforced web		up to and including 6' height		
3" x 3" x .120" aluminum		over 6' and including 8' height		
4" x 4" x .250" aluminum		over 8' and up to 10' height		
GATE LEAF	GATE HEIGHT			
	up to & including 4'	Over 4' to 6'	Over 6' to 8'	Over 8' to 10'
up to 4'	3" x 3" x .120" alum.	4" x 4" x .250" alum. or 3" x 12 ga. steel	4" x 11 ga. steel	4" x 11 ga. steel
4'1" to 6'	4" x 4" x .250" alum or 3" x 12 ga. steel	3" x 12 ga. steel	4" x 11 ga. steel	4" x 11 ga. steel
6'1" to 8'	4" x 11 ga. steel	4" x 11 ga. steel	4" x 11 ga. steel	6" x ¾" steel
8'1" to 10'	4" x 11 ga. steel	4" x 11 ga. steel	6" x ¾" steel	6" x ¾" steel
10'1" to 12'	4" x 11 ga. steel	6" x ¾" steel	6" x ¾" steel	6" x ¾" steel
12'1" to 16'	6" x ¾" steel	6" x ¾" steel	6" x ¾" steel	6" x ¾" steel

TABLE 2

COATING PERFORMANCE REQUIREMENTS		
QUALITY CHARACTERISTICS	ASTM TEST METHOD	PERFORMANCE REQUIREMENTS
ADHESION	D3359 – METHOD B	Adhesion (retention of coating) over 90% of test area (tape and knife kit test).
CORROSION RESISTANCE	B117, D714, D1654	Corrosion resistance over 1,000 hours (scribed per D1654; failure mode is accumulation of 1/8" coating loss from scribe or medium #8 blisters)
IMPACT RESISTANCE	D2794	Impact resistance over 60" lb. (forward impact using 0.625" ball).
WEATHERING RESISTANCE	D822 D2244, D523 (60° method)	Weathering resistance over 1,000 hours (failure mode is 60% loss of gloss or color variance of more than 3 delta-E color units).

TABLE 3

ECHELON II POST SPACING BY BRACKET TYPE								
SPAN	Invincible: 8' / 6' nominal (91.25" / 71.375" rails)			Classic, Genesis & Majestic: 8' / 6' nominal (92.625" / 67.75" rails)				
	2½"	3"		2½"	3"	2½"	3"	2½"
BRACKET TYPE	Industrial Flat Mount (BB301)		Industrial Universal (BB302)	Industrial Universal (BB303)	Industrial Flat Mount (BB301)		Industrial Swivel (BB304)*	
POST SETTINGS ± ½" O.C.	94.5" / 75"	95" / 75.5"	96" / 71.5"	96.5" / 72"	96" / 71.5"	96.5" / 72"	*97.5" / *73"	*98" / *73.5"

*When using BB113 swivel brackets on either or both ends of a panel installation, care must be taken to ensure the spacing between post and adjoining pickets meets applicable codes. This will require trimming one or both ends of the panel. When using the BB301 flat mount bracket for Invincible style, rail may need to be drilled to accommodate rail to bracket attachment.

TABLE 4

ECHELON II WIND LOADING				
FENCE HEIGHT	RAIL LENGTH	POST SIZE	WIND LOAD CAPACITY FACTOR (PSF)	TYPICAL WIND LOAD CAPACITY (MPH)
4'	6'	2½"s	112 (PSF)	206 (MPH)
		3"sq.	213 (PSF)	285 (MPH)
	8'	2½"sq.	84 (PSF)	178 (MPH)
		3"sq.	160 (PSF)	246 (MPH)
5'	6'	2½"sq.	76 (PSF)	170 (MPH)
		3"sq.	145 (PSF)	235 (MPH)
	8'	2½"sq.	57 (PSF)	147 (MPH)
		3"sq.	109 (PSF)	203 (MPH)
6'	6'	2½"sq.	52 (PSF)	141 (MPH)
		3"sq.	99 (PSF)	194 (MPH)
	8'	2½"sq.	40 (PSF)	123 (MPH)
		3"sq.	76 (PSF)	171 (MPH)
7'	6'	2½"sq.	38 (PSF)	120 (MPH)
		3"sq.	73 (PSF)	166 (MPH)
	8'	2½"sq.	28 (PSF)	104 (MPH)
		3"sq.	55 (PSF)	144 (MPH)
8'	6'	2½"sq.	29 (PSF)	105 (MPH)
		3"sq.	56 (PSF)	145 (MPH)
	8'	2½"sq.	22 (PSF)	91 (MPH)
		3"sq.	42 (PSF)	126 (MPH)
9'	6'	4"sq.	78 (PSF)	172 (MPH)
		4"sq.	82 (PSF)	176 (MPH)
10'	6'	4"sq.	66 (PSF)	159 (MPH)

MPH values shown in Table 4 are provided for information only. They are calculated using ANSISASCE 7-05, "American Society of Civil Engineers Minimum Design Loads for Buildings and Other Structures" Exposure Category C (open terrain with scattered obstructions having lengths generally less than 30 feet), based on post setting in 36" deep concrete footer in soil assumed to be of mid-range strength and compaction. Since specified project conditions such as jurisdictional building codes, elevation of installation, post base/footer design, soil strength, etc., may change from project to project, a structural engineering evaluation, unique to applicable requirements and conditions, should be performed. Consult your Ameristar Service Representative for an estimate on Engineering Analysis and P.E. Certification.

Effective: 01/06/15

EHELON II® | LIMITED LIFETIME WARRANTY

INDUSTRIAL ALUMINUM ORNAMENTAL FENCE

Echelon II® Industrial Aluminum Ornamental Fence System by Ameristar® is manufactured from the highest quality materials by skilled craftsmen to meet the highest standards of workmanship in the industry. Extruded aluminum framework shall be subject to a six stage pretreatment/wash followed by an electrostatic spray application of “no-mar” TGIC polyester powder coat finish, which provides the protection necessary to withstand adverse environmental conditions.

The powder coated surface on all aluminum framework (*i.e., pickets, rails and posts*) by Ameristar is guaranteed under normal and proper usage, against cracking, peeling, chipping, blistering or corroding for a lifetime limited period. Normal and proper usage does not include physical damage, abrasion or exposure to salty environments to the protective coating.

Echelon II Industrial Aluminum Ornamental Fence System framework is also guaranteed for the same period of time against defects in workmanship or materials.

Should any ornamental fence framework manufactured by Ameristar Fence Products fail in accordance with any of the above conditions, Ameristar Fence Products warrants to the original purchaser their redemption through replacement or renewal. The decision as to which method of redemption is allowed is solely at the discretion of Ameristar. Notice of failure under the conditions of this warranty shall be sent to Ameristar Fence Products or its authorized representative, in writing, together with proof of purchase and shall specify the nature of the defect and when it was first observed. Should the fence be improperly installed, Ameristar Fence Products shall not be responsible for guaranteed performance or appearance of the material. Neither does this guarantee apply when failure or damage is due to improper use or application, abuse or misuse, vandalism or acts of God. Ameristar Fence Products reserves the right to inspect the material to determine validity of the claim.

Upon validation of the claim by Ameristar Fence Products or its authorized representative, redemption by replacement or renewal shall be made by Ameristar Fence Products. Reimbursement for the costs of removal and installation of materials are not included in the guarantee, nor will Ameristar Fence Products provide those services.

The above constitutes the complete warranty by the manufacturer. No other agreement, written or implied, is valid. Ameristar Fence Products does not authorize any other person or agent to make any other express warranties. Ameristar Fence Products neither assumes nor authorizes any other person or agent to assume any other liability in connection with Echelon II Industrial Aluminum Ornamental Fence System. Some jurisdictions do not allow limitations on how long an implied warranty lasts, nor do they allow an exclusion or limitation of incidental or consequential damages; therefore, the limitations and exclusions noted herein may not apply.

Effective: 01/06/15

ECHELON II® | SINGLE SWING w/STRAIGHT PICKETS GATE SPECIFICATIONS

2"sq x .25" wall GATE ENDS | 1.75" ForeRunner™ RAILS | 1"sq x .125" wall PICKETS | 3.5' - 14' NOMINAL OPENINGS

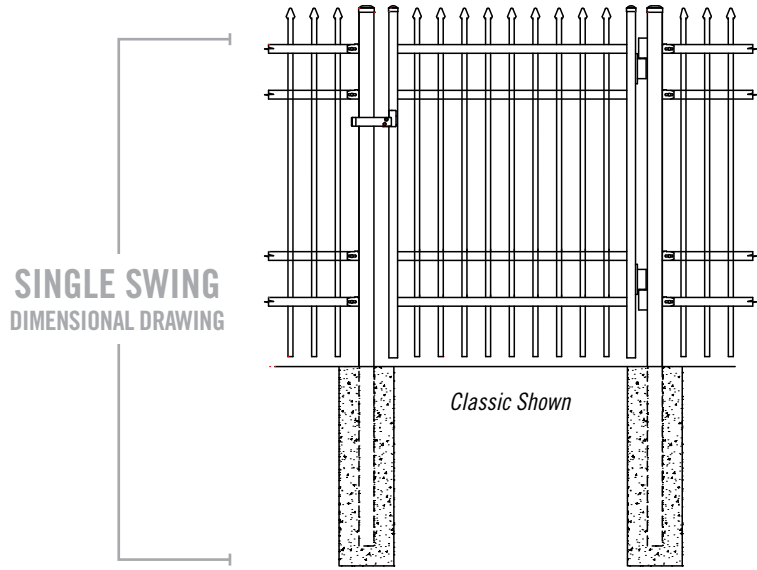

SINGLE SWING
HARDWARE KITS & POST
INTERSPACES

OPENING	LEAF WIDTH*	HC	LC	P _s	HC	LC	P _s	HC	LC	P _s
3.5'	40.25"	2.375"	2"	44.625"	1.25"	3"	44.5"	1.5"	3"	44.75"
4'	49.5"	2.375"	2"	53.875"	1.25"	3"	53.75"	1.5"	3"	54"
5'	59"	2.375"	2"	63.375"	1.25"	3"	63.25"	1.5"	3"	63.5"
6'	68.5"	2.375"	2"	72.875"	1.25"	3"	72.75"	1.5"	3"	73"
7'	78"	2.375"	2"	82.375"	1.25"	3"	82.25"	1.5"	3"	82.5"
8'	96.75"	2.375"	2"	101.125"	1.25"	3"	101"	1.5"	3"	101.25"
9'	106.25"	2.375"	2"	110.625"	1.25"	3"	110.5"	1.5"	3"	110.75"
10'	115.5"	2.375"	2"	119.875"	1.25"	3"	119.75"	1.5"	3"	120"
11'	134.5"	2.375"	2"	138.875"	1.25"	3"	138.75"	1.5"	3"	139"
12'	143.75"	2.375"	2"	148.125"	1.25"	3"	148"	1.5"	3"	148.25"
13'	153.25"	2.375"	2"	157.625"	1.25"	3"	157.5"	1.5"	3"	157.75"
14'	162.75"	2.375"	2"	167.125"	1.25"	3"	167"	1.5"	3"	167.25"

W = width* | HC = hinge clearance | LC = latch clearance | P_s = gate post spacing**
 * From outside to outside | ** From inside to inside

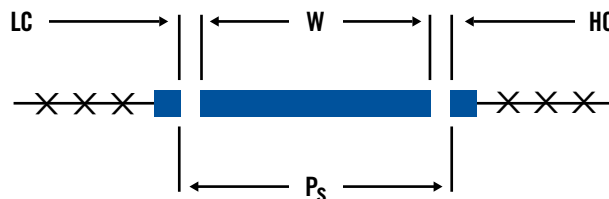

Effective: 01/06/15

ECHELON II® | DOUBLE SWING w/STRAIGHT PICKETS GATE SPECIFICATIONS

2"sq x .25" wall GATE ENDS | 1.75" ForeRunner™ RAILS | 1"sq x .125" wall PICKETS | 7' - 28' NOMINAL OPENINGS

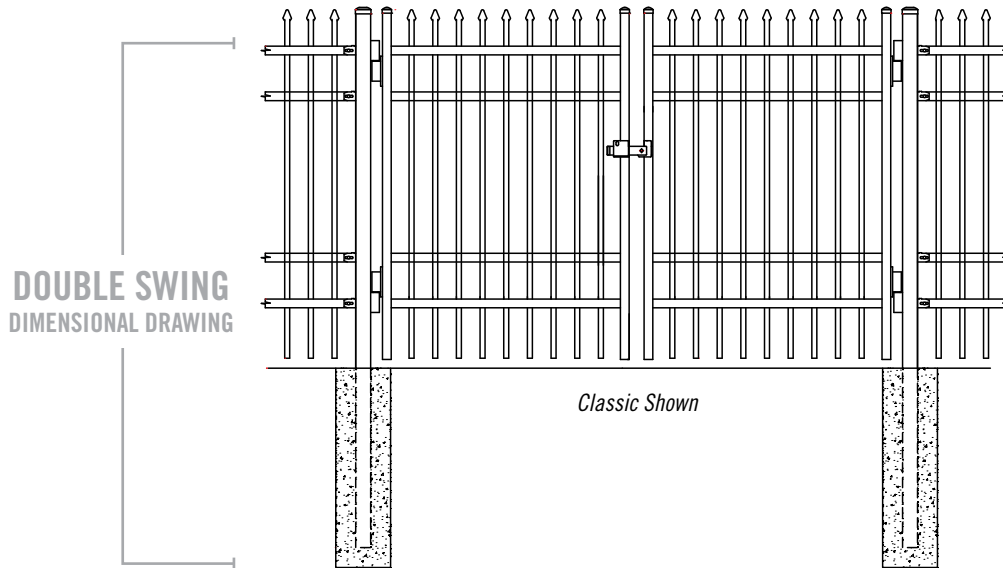

OPENING	LEAF WIDTH*	EGBDX FORK LATCH / BOX HINGE KIT			IGBD INDUSTRIAL HINGE KIT WITH STRONG ARM LATCH		
		HC	LC	P _d	HC	LC	P _d
7'	40.25"	2.375"	2"	87.25"	1.5"	2"	85.5"
8'	49.5"	2.375"	2"	105.75"	1.5"	2"	104"
10'	59"	2.375"	2"	124.75"	1.5"	2"	123"
12'	68.5"	2.375"	2"	143.75"	1.5"	2"	142"
14'	78"	2.375"	2"	162.75"	1.5"	2"	161"
16'	96.75"	2.375"	2"	200.25"	1.5"	2"	198.5"
18'	106.25"	2.375"	2"	219.25"	1.5"	2"	217.5"
20'	115.5"	2.375"	2"	237.75"	1.5"	2"	236"
22'	134.5"	2.375"	2"	275.75"	1.5"	2"	274"
24'	143.75"	2.375"	2"	294.25"	1.5"	2"	292.5"
26'	153.25"	2.375"	2"	313.25"	1.5"	2"	311.5"
28'	162.75"	2.375"	2"	332.25"	1.5"	2"	330.5"

DOUBLE SWING
HARDWARE KITS & POST
INTERSPACES

W = width (x2)* | HC = hinge clearance (x2) | LC = latch clearance
P_d = gate post spacing**
* From outside to outside | ** From inside to inside

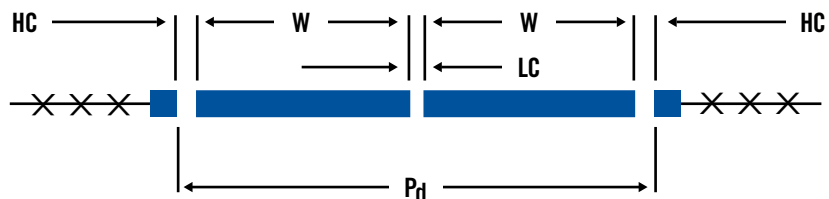

Effective: 01/06/15

ECHELON II® | SINGLE SWING w/CURVED PICKETS GATE SPECIFICATIONS

2"sq x .25" wall GATE ENDS | 1.75" ForeRunner™ RAILS | 1"sq x .125" wall PICKETS | 3.5' - 14' NOMINAL OPENINGS

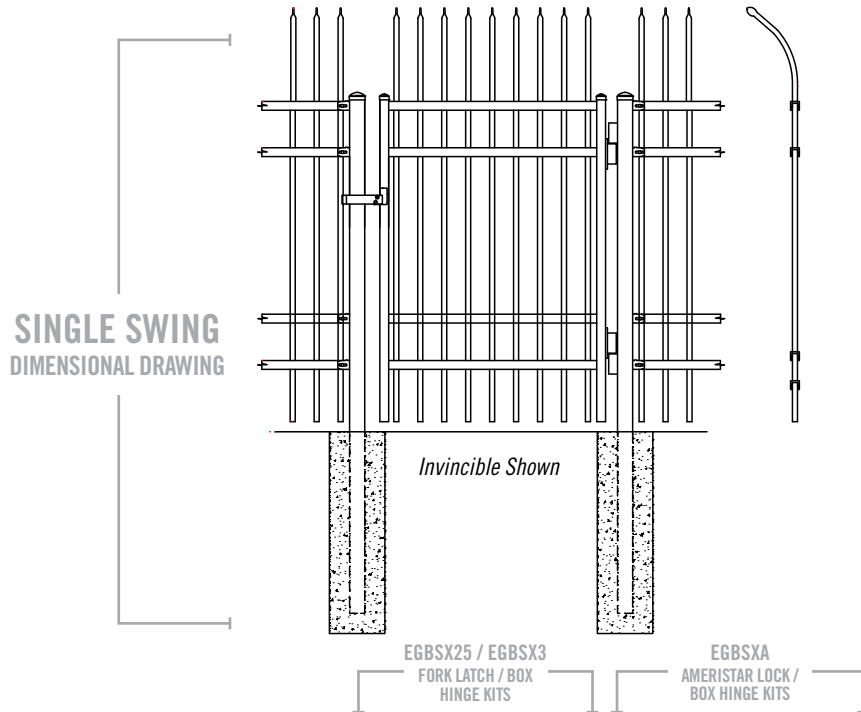

SINGLE SWING
 HARDWARE KITS & POST
 INTERSPACES

OPENING	LEAF WIDTH*	HC	LC	P _S	HC	LC	P _S
3.5'	40"	2.375"	2"	44.375"	2.375"	.625"	43"
4'	44.75"	2.375"	2"	49.125"	2.375"	.625"	47.75"
5'	58.875"	2.375"	2"	63.25"	2.375"	.625"	61.875"
6'	68.25"	2.375"	2"	72.625"	2.375"	.625"	71.25"
7'	82.375"	2.375"	2"	86.75"	2.375"	.625"	85.375"
8'	91.875"	2.375"	2"	96.25"	2.375"	.625"	94.875"
9'	106"	2.375"	2"	110.375"	2.375"	.625"	109"
10'	115.375"	2.375"	2"	119.75"	2.375"	.625"	118.375"
11'	129.5"	2.375"	2"	133.875"	2.375"	.625"	132.5"
12'	139"	2.375"	2"	143.375"	2.375"	.625"	142"
13'	153.125"	2.375"	2"	157.5"	2.375"	.625"	156.125"
14'	167.25"	2.375"	2"	171.625"	2.375"	.625"	170.25"

W = width* | HC = hinge clearance | LC = latch clearance | P_S = gate post spacing**
 * From outside to outside | ** From inside to inside

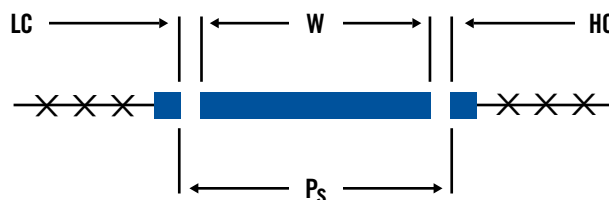

Effective: 01/06/15

ECHELON II® | DOUBLE SWING w/CURVED PICKETS GATE SPECIFICATIONS

2"sq x .25" wall GATE ENDS | 1.75" ForeRunner™ RAILS | 1"sq x .125" wall PICKETS | 7' - 28' NOMINAL OPENINGS

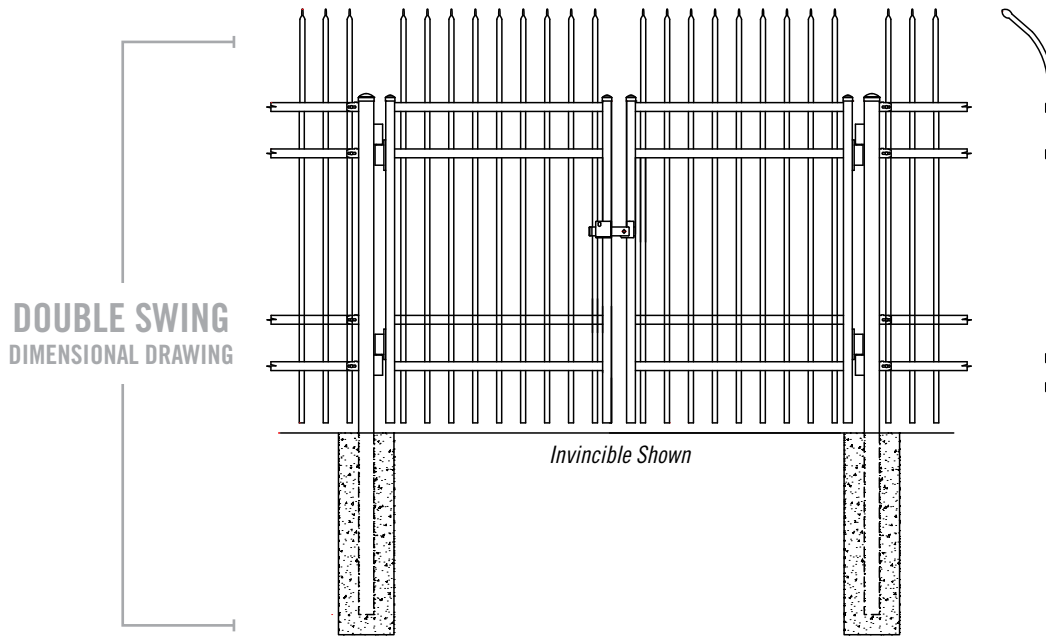

EGBDX FORK LATCH / BOX HINGE KIT | HGBD HEAVY COMMERCIAL HINGE KIT

DOUBLE SWING HARDWARE KITS & POST INTERSPACES

OPENING	LEAF WIDTH*	HC	LC	P _d	HC	LC	P _d
7'	40"	2.375"	2"	86.75"	1.25"	2"	84.5"
8'	44.75"	2.375"	2"	96.25"	1.25"	2"	94"
10'	58.875"	2.375"	2"	124.5"	1.25"	2"	122.25"
12'	68.25"	2.375"	2"	143.25"	1.25"	2"	141"
14'	82.375"	2.375"	2"	171.5"	1.25"	2"	169.25"
16'	91.875"	2.375"	2"	190.5"	1.25"	2"	188.25"
18'	106"	2.375"	2"	218.75"	1.25"	2"	216.5"
20'	115.375"	2.375"	2"	237.5"	1.25"	2"	235.25"
21'	129.5"	2.375"	2"	265.75"	1.25"	2"	263.5"
24'	139"	2.375"	2"	284.75"	1.25"	2"	282.5"
26'	153.125"	2.375"	2"	313"	1.25"	2"	310.75"
28'	167.25"	2.375"	2"	341.25"	1.25"	2"	339"

W = width (x2)* | HC = hinge clearance (x2) | LC = latch clearance

P_d = gate post spacing**

* From outside to outside | ** From inside to inside

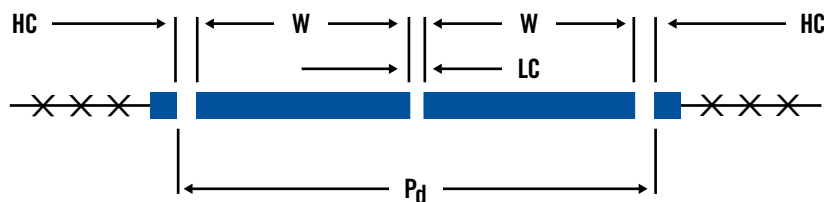

Effective: 01/06/15

ECHELON II® | 2-RAIL SINGLE SWING GATES

4" AIR GAP | STANDARD BOTTOM | GATE HARDWARE NOT INCLUDED

	OPENING	LEAF WIDTH	ITEM NUMBER	PICKET QTY	WEIGHT	STOCKING
4' HEIGHT	3½'	40.25"	2A☒☉2048-42	7	37 lbs	☉
	4'	49.5"	2A☒☉2048-48	9	42 lbs	☉
	5'	59"	2A☒☉2048-60	11	48 lbs	☉
	6'	68.5"	2A☒☉2048-72	13	54 lbs	☉
	7'	78"	2A☒☉2048-84	15	69 lbs	☉
	8'	96.75"	2A☒☉2048-96	19	75 lbs	☉
	9'	106.25"	2A☒☉2048-108	21	85 lbs	☉
	10'	115.5"	2A☒☉2048-120	23	91 lbs	☉
	11'	134.5"	2A☒☉2048-132	27	99 lbs	☉
	12'	143.75"	2A☒☉2048-144	29	105 lbs	☉
5' HEIGHT	13'	153.25"	2A☒☉2048-156	31	111 lbs	☉
	14'	162.75"	2A☒☉2048-168	33	127 lbs	☉
	3½'	40.25"	2A☒☉2058-42	7	44 lbs	☉
	4'	49.5"	2A☒☉2058-48	9	51 lbs	☉
	5'	59"	2A☒☉2058-60	11	58 lbs	☉
	6'	68.5"	2A☒☉2058-72	13	65 lbs	☉
	7'	78"	2A☒☉2058-84	15	82 lbs	☉
	8'	96.75"	2A☒☉2058-96	19	89 lbs	☉
	9'	106.25"	2A☒☉2058-108	21	101 lbs	☉
	10'	115.5"	2A☒☉2058-120	23	108 lbs	☉
11'	134.5"	2A☒☉2058-132	27	117 lbs	☉	
12'	143.75"	2A☒☉2058-144	29	124 lbs	☉	
13'	153.25"	2A☒☉2058-156	31	131 lbs	☉	
14'	162.75"	2A☒☉2058-168	33	151 lbs	☉	

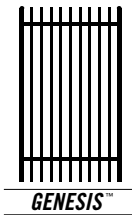
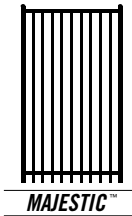
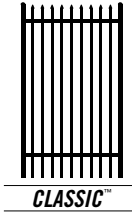

☒ = FENCE STYLES AVAILABLE | **C** = Classic **M** = Majestic **G** = Genesis
 ☉ = COLOR OPTIONS AVAILABLE | **B** = Black **N** = Bronze **W** = White **S** = Sand

NOTE: Genesis gates do not have picket plugs.

Effective: 01/06/15

ECHELON II® | 2-RAIL SINGLE SWING GATES

4" AIR GAP | STANDARD BOTTOM | GATE HARDWARE NOT INCLUDED

OPENING	LEAF WIDTH	ITEM NUMBER	PICKET QTY	WEIGHT	STOCKING
3½'	40.25"	2A☒⊗2070-42	7	51 lbs	☉
4'	49.5"	2A☒⊗2070-48	9	59 lbs	☉
5'	59"	2A☒⊗2070-60	11	67 lbs	☉
6'	68.5"	2A☒⊗2070-72	13	75 lbs	☉
7'	78"	2A☒⊗2070-84	15	96 lbs	☉
8'	96.75"	2A☒⊗2070-96	19	104 lbs	☉
9'	106.25"	2A☒⊗2070-108	21	117 lbs	☉
10'	115.5"	2A☒⊗2070-120	23	125 lbs	☉
11'	134.5"	2A☒⊗2070-132	27	137 lbs	☉
12'	143.75"	2A☒⊗2070-144	29	145 lbs	☉
13'	153.25"	2A☒⊗2070-156	31	153 lbs	☉
14'	162.75"	2A☒⊗2070-168	33	175 lbs	☉

6'
HEIGHT

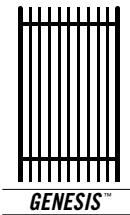
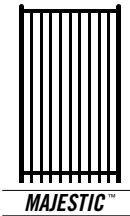
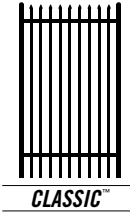

☒ = FENCE STYLES AVAILABLE | C = Classic M = Majestic G = Genesis
 ⊗ = COLOR OPTIONS AVAILABLE | B = Black N = Bronze W = White S = Sand

NOTE: Genesis gates do not have picket plugs.

Effective: 01/06/15

ECHELON II® | 3-RAIL SINGLE SWING GATES

4" AIR GAP | STANDARD BOTTOM | GATE HARDWARE NOT INCLUDED

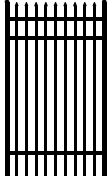
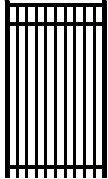
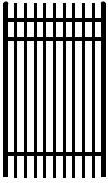
	OPENING	LEAF WIDTH	ITEM NUMBER	PICKET QTY	WEIGHT	STOCKING			
4' HEIGHT	3½'	40.25"	2A☒☒3048-42	7	40 lbs	☉			
	4'	49.5"	2A☒☒3048-48	9	46 lbs	☉			
	5'	59"	2A☒☒3048-60	11	53 lbs	☉			
		6'	68.5"	2A☒☒3048-72	13	60 lbs	☉		
		7'	78"	2A☒☒3048-84	15	76 lbs	☉		
		8'	96.75"	2A☒☒3048-96	19	83 lbs	☉		
		9'	106.25"	2A☒☒3048-108	21	93 lbs	☉		
		10'	115.5"	2A☒☒3048-120	23	100 lbs	☉		
		11'	134.5"	2A☒☒3048-132	27	109 lbs	☉		
		12'	143.75"	2A☒☒3048-144	29	116 lbs	☉		
		13'	153.25"	2A☒☒3048-156	31	123 lbs	☉		
		14'	162.75"	2A☒☒3048-168	33	140 lbs	☉		
	5' HEIGHT	3½'	40.25"	2A☒☒3058-42	7	47 lbs	☉		
		4'	49.5"	2A☒☒3058-48	9	55 lbs	☉		
5'		59"	2A☒☒3058-60	11	63 lbs	☉			
6'		68.5"	2A☒☒3058-72	13	71 lbs	☉			
7'		78"	2A☒☒3058-84	15	89 lbs	☉			
8'		96.75"	2A☒☒3058-96	19	97 lbs	☉			
9'		106.25"	2A☒☒3058-108	21	109 lbs	☉			
10'		115.5"	2A☒☒3058-120	23	117 lbs	☉			
11'		134.5"	2A☒☒3058-132	27	127 lbs	☉			
12'		143.75"	2A☒☒3058-144	29	135 lbs	☉			
13'		153.25"	2A☒☒3058-156	31	143 lbs	☉			
14'		162.75"	2A☒☒3058-168	33	164 lbs	☉			
6' HEIGHT		3½'	40.25"	2A☒☒3070-42	7	55 lbs	☉		
		4'	49.5"	2A☒☒3070-48	9	63 lbs	☉		
	5'	59"	2A☒☒3070-60	11	75 lbs	☉			
	6'	68.5"	2A☒☒3070-72	13	81 lbs	☉			
	7'	78"	2A☒☒3070-84	15	103 lbs	☉			
	8'	96.75"	2A☒☒3070-96	19	112 lbs	☉			
	9'	106.25"	2A☒☒3070-108	21	123 lbs	☉			
	10'	115.5"	2A☒☒3070-120	23	132 lbs	☉			
	11'	134.5"	2A☒☒3070-132	27	145 lbs	☉			
	12'	143.75"	2A☒☒3070-144	29	154 lbs	☉			
	13'	153.25"	2A☒☒3070-156	31	163 lbs	☉			
	14'	162.75"	2A☒☒3070-168	33	186 lbs	☉			

7' HEIGHT CONTINUED ON NEXT PAGE

Effective: 01/06/15

ECHELON II® | 3-RAIL SINGLE SWING GATES

4" AIR GAP | STANDARD BOTTOM | GATE HARDWARE NOT INCLUDED

	OPENING	LEAF WIDTH	ITEM NUMBER	PICKET QTY	WEIGHT	STOCKING
7' HEIGHT	3½'	40.25" / 40"†	2A☒Ⓞ3082-42	7	62 / 64†	☉
	4'	49.5" / 44.75"†	2A☒Ⓞ3082-48	9	71 / 73†	☉
	5'	59" / 58.875"†	2A☒Ⓞ3082-60	11	81 / 83†	☉
	6'	68.5" / 68.25"†	2A☒Ⓞ3082-72	13	91 / 93†	☉
	7'	78" / 82.375"†	2A☒Ⓞ3082-84	15	115 / 117†	☉
	8'	96.75" / 91.875"†	2A☒Ⓞ3082-96	19	124 / 127†	☉
	9'	106.25" / 106"†	2A☒Ⓞ3082-108	21	138 / 146†	☉
	10'	115.5" / 115.375"†	2A☒Ⓞ3082-120	23	148 / 156†	☉
	11'	134.5" / 129.5"†	2A☒Ⓞ3082-132	27	162 / 166†	☉
	12'	143.75" / 139"†	2A☒Ⓞ3082-144	29	171 / 173†	☉
	13'	153.25" / 153.125"†	2A☒Ⓞ3082-156	31	181 / 185†	☉
	14'	162.75" / 167.25"†	2A☒Ⓞ3082-168	33	209 / 219†	☉

☒ = FENCE STYLES AVAILABLE | C = Classic M = Majestic G = Genesis I = Invincible†

Ⓞ = COLOR OPTIONS AVAILABLE | B = Black N = Bronze W = White S = Sand

☉ = NON-STOCKED PRODUCT

For details, see Ameristar's Sales Policy in the catalog guide.

NOTE: Genesis gates do not have picket plugs.

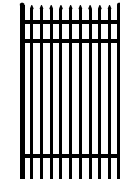

CLASSIC™

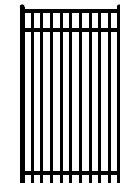

MAJESTIC™

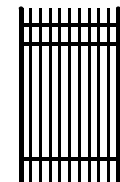

GENESIS™

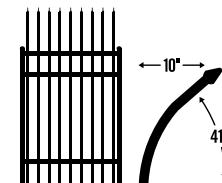

INVINCIBLE™

Effective: 01/06/15

ECHELON II® | 3-RAIL SINGLE SWING GATES WITH RINGS

4" AIR GAP | STANDARD BOTTOM | GATE HARDWARE NOT INCLUDED

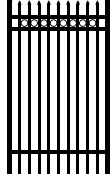
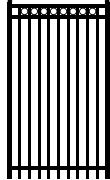
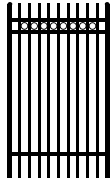
	OPENING	LEAF WIDTH	ITEM NUMBER	PICKET QTY	WEIGHT	STOCKING	
4' HEIGHT	3½'	40.25"	2A☒☒3048-42R	7	42 lbs	☉	 CLASSIC™
	4'	49.5"	2A☒☒3048-48R	9	49 lbs	☉	
	5'	59"	2A☒☒3048-60R	11	56 lbs	☉	
	6'	68.5"	2A☒☒3048-72R	13	64 lbs	☉	
	7'	78"	2A☒☒3048-84R	15	81 lbs	☉	
	8'	96.75"	2A☒☒3048-96R	19	88 lbs	☉	
	9'	106.25"	2A☒☒3048-108R	21	101 lbs	☉	
	10'	115.5"	2A☒☒3048-120R	23	109 lbs	☉	
	11'	134.5"	2A☒☒3048-132R	27	119 lbs	☉	
	12'	143.75"	2A☒☒3048-144R	29	126 lbs	☉	
5' HEIGHT	13'	153.25"	2A☒☒3048-156R	31	134 lbs	☉	 MAJESTIC™
	14'	162.75"	2A☒☒3048-168R	33	152 lbs	☉	
	3½'	40.25"	2A☒☒3058-42R	7	49 lbs	☉	
	4'	49.5"	2A☒☒3058-48R	9	57 lbs	☉	
	5'	59"	2A☒☒3058-60R	11	66 lbs	☉	
	6'	68.5"	2A☒☒3058-72R	13	75 lbs	☉	
	7'	78"	2A☒☒3058-84R	15	94 lbs	☉	
	8'	96.75"	2A☒☒3058-96R	19	102 lbs	☉	
	9'	106.25"	2A☒☒3058-108R	21	117 lbs	☉	
	10'	115.5"	2A☒☒3058-120R	23	126 lbs	☉	
6' HEIGHT	11'	134.5"	2A☒☒3058-132R	27	137 lbs	☉	 GENESIS™
	12'	143.75"	2A☒☒3058-144R	29	145 lbs	☉	
	13'	153.25"	2A☒☒3058-156R	31	154 lbs	☉	
	14'	162.75"	2A☒☒3058-168R	33	176 lbs	☉	
	3½'	40.25"	2A☒☒3070-42R	7	57 lbs	☉	
	4'	49.5"	2A☒☒3070-48R	9	66 lbs	☉	
	5'	59"	2A☒☒3070-60R	11	77 lbs	☉	
	6'	68.5"	2A☒☒3070-72R	13	85 lbs	☉	
	7'	78"	2A☒☒3070-84R	15	108 lbs	☉	
	8'	96.75"	2A☒☒3070-96R	19	117 lbs	☉	
9'	106.25"	2A☒☒3070-108R	21	133 lbs	☉		
10'	115.5"	2A☒☒3070-120R	23	143 lbs	☉		
11'	134.5"	2A☒☒3070-132R	27	157 lbs	☉		
12'	143.75"	2A☒☒3070-144R	29	166 lbs	☉		
13'	153.25"	2A☒☒3070-156R	31	176 lbs	☉		
14'	162.75"	2A☒☒3070-168R	33	200 lbs	☉		

7' HEIGHT CONTINUED ON NEXT PAGE

Effective: 01/06/15

ECHELON II® | 3-RAIL SINGLE SWING GATES WITH RINGS

4" AIR GAP | STANDARD BOTTOM | GATE HARDWARE NOT INCLUDED

OPENING	LEAF WIDTH	ITEM NUMBER	PICKET QTY	WEIGHT	STOCKING
3½'	40.25"	2A☒☒3082-42R	7	64 lbs	☉
4'	49.5"	2A☒☒3082-48R	9	74 lbs	☉
5'	59"	2A☒☒3082-60R	11	84 lbs	☉
6'	68.5"	2A☒☒3082-72R	13	95 lbs	☉
7'	78"	2A☒☒3082-84R	15	120 lbs	☉
8'	96.75"	2A☒☒3082-96R	19	130 lbs	☉
9'	106.25"	2A☒☒3082-108R	21	148 lbs	☉
10'	115.5"	2A☒☒3082-120R	23	159 lbs	☉
11'	134.5"	2A☒☒3082-132R	27	174 lbs	☉
12'	143.75"	2A☒☒3082-144R	29	183 lbs	☉
13'	153.25"	2A☒☒3082-156R	31	194 lbs	☉
14'	162.75"	2A☒☒3082-168R	33	223 lbs	☉

7'
HEIGHT

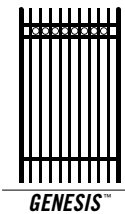
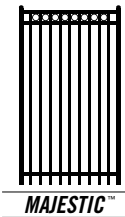
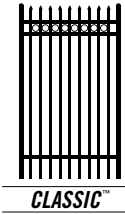

☒ = FENCE STYLES AVAILABLE | C = Classic M = Majestic G = Genesis

☒ = COLOR OPTIONS AVAILABLE | B = Black N = Bronze W = White S = Sand

☉ = NON-STOCKED PRODUCT

For details, see Ameristar's Sales Policy in the catalog guide.

NOTE: Genesis gates do not have picket plugs.

Effective: 01/06/15

ECHELON II® | 4-RAIL SINGLE SWING GATES

4" AIR GAP | STANDARD BOTTOM | GATE HARDWARE NOT INCLUDED

	OPENING	LEAF WIDTH	ITEM NUMBER	PICKET QTY	WEIGHT	STOCKING
8' HEIGHT	3½'	40.25" / 40"†	2A☒⊗4094-42	7	73 / 75†	⊙
	4'	49.5" / 44.75"†	2A☒⊗4094-48	9	84 / 86†	⊙
	5'	59" / 58.875"†	2A☒⊗4094-60	11	95 / 97†	⊙
	6'	68.5" / 68.25"†	2A☒⊗4094-72	13	107 / 109†	⊙
	7'	78" / 82.375"†	2A☒⊗4094-84	15	136 / 138†	⊙
	8'	96.75" / 91.875"†	2A☒⊗4094-96	19	147 / 149†	⊙
	9'	106.25" / 106"†	2A☒⊗4094-108	21	181 / 172†	⊙
	10'	115.5" / 115.375"†	2A☒⊗4094-120	23	193 / 183†	⊙
	11'	134.5" / 129.5"†	2A☒⊗4094-132	27	210 / 195†	⊙
	12'	143.75" / 139"†	2A☒⊗4094-144	29	223 / 205†	⊙
9' HEIGHT	13'	153.25" / 153.125"†	2A☒⊗4094-156	31	235 / 218†	⊙
	14'	162.75" / 167.25"†	2A☒⊗4094-168	33	271 / 257†	⊙
	3½'	40.25" / 40"†	2A☒⊗4106-42	7	80 / 82†	⊙
	4'	49.5" / 44.75"†	2A☒⊗4106-48	9	92 / 94†	⊙
	5'	59" / 58.875"†	2A☒⊗4106-60	11	105 / 107†	⊙
	6'	68.5" / 68.25"†	2A☒⊗4106-72	13	117 / 119	⊙
	7'	78" / 82.375"†	2A☒⊗4106-84	15	149 / 151†	⊙
	8'	96.75" / 91.875"†	2A☒⊗4106-96	19	161 / 163†	⊙
10' HEIGHT	3½'	40.25" / 40"†	2A☒⊗4118-42	7	88 / 91†	⊙
	4'	49.5" / 44.75"†	2A☒⊗4118-48	9	100 / 103†	⊙
	5'	59" / 58.875"†	2A☒⊗4118-60	11	114 / 117†	⊙
	6'	68.5" / 68.25"†	2A☒⊗4118-72	13	128 / 131†	⊙
	7'	78" / 82.375"†	2A☒⊗4118-84	15	162 / 165†	⊙
	8'	96.75" / 91.875"†	2A☒⊗4118-96	19	176 / 179†	⊙

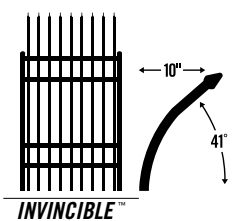
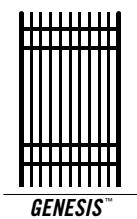
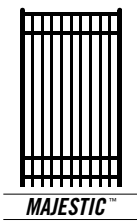
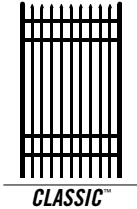

☒ = FENCE STYLES AVAILABLE | C = Classic | M = Majestic | G = Genesis | I = Invincible†
 ⊗ = COLOR OPTIONS AVAILABLE | B = Black | N = Bronze | W = White | S = Sand
 ⊙ = NON-STOCKED PRODUCT
 For details, see Ameristar's Sales Policy in the catalog guide.

NOTE: Genesis gates do not have picket plugs.

Effective: 01/06/15

ECHELON II® | 4-RAIL SINGLE SWING GATES WITH RINGS

4" AIR GAP | STANDARD BOTTOM | GATE HARDWARE NOT INCLUDED

	OPENING	LEAF WIDTH	ITEM NUMBER	PICKET QTY	WEIGHT	STOCKING
8' HEIGHT	3½'	40.25"	2A☒⊗4094-42R	7	77 lbs	⊙
	4'	49.5"	2A☒⊗4094-48R	9	89 lbs	⊙
	5'	59"	2A☒⊗4094-60R	11	102 lbs	⊙
	6'	68.5"	2A☒⊗4094-72R	13	115 lbs	⊙
	7'	78"	2A☒⊗4094-84R	15	145 lbs	⊙
	8'	96.75"	2A☒⊗4094-96R	19	157 lbs	⊙
	9'	106.25"	2A☒⊗4094-108R	21	181 lbs	⊙
9' HEIGHT	10'	115.5"	2A☒⊗4094-120R	23	193 lbs	⊙
	11'	134.5"	2A☒⊗4094-132R	27	210 lbs	⊙
	12'	143.75"	2A☒⊗4094-144R	29	223 lbs	⊙
	13'	153.25"	2A☒⊗4094-156R	31	235 lbs	⊙
	14'	162.75"	2A☒⊗4094-168R	33	271 lbs	⊙
	3½'	40.25"	2A☒⊗4106-42R	7	84 lbs	⊙
	4'	49.5"	2A☒⊗4106-48R	9	97 lbs	⊙
10' HEIGHT	5'	59"	2A☒⊗4106-60R	11	112 lbs	⊙
	6'	68.5"	2A☒⊗4106-72R	13	125 lbs	⊙
	7'	78"	2A☒⊗4106-84R	15	158 lbs	⊙
	8'	96.75"	2A☒⊗4106-96R	19	171 lbs	⊙
10' HEIGHT	3½'	40.25"	2A☒⊗4118-42R	7	92 lbs	⊙
	4'	49.5"	2A☒⊗4118-48R	9	105 lbs	⊙
	5'	59"	2A☒⊗4118-60R	11	121 lbs	⊙
	6'	68.5"	2A☒⊗4118-72R	13	136 lbs	⊙
	7'	78"	2A☒⊗4118-84R	15	171 lbs	⊙
	8'	96.75"	2A☒⊗4118-96R	19	186 lbs	⊙

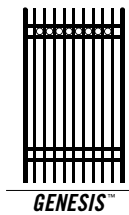
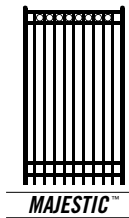
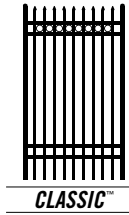

☒ = FENCE STYLES AVAILABLE | C = Classic M = Majestic G = Genesis
 ⊗ = COLOR OPTIONS AVAILABLE | B = Black N = Bronze W = White S = Sand
 ⊙ = NON-STOCKED PRODUCT
 For details, see Ameristar's Sales Policy in the catalog guide.

NOTE: Genesis gates do not have picket plugs.

Effective: 01/06/15

Effective: 01/06/15

Effective: 01/06/15

TO PLACE YOUR ORDER CALL 888-333-3422 | VISIT AMERISTARFENCE.COM

AMERISTAR®
ASSA ABLOY

Effective: 01/06/15