

THERMA-FUSER™ SYSTEMS

THERMALLY POWERED VAV DIFFUSER

DESIGNING THERMA-FUSER™ VAV SYSTEMS



	PAGE
CHAPTER 1: SIZING AND LOCATION OF THERMA-FUSER DIFFUSERS	2
CHAPTER 2: SUPPLY AIR TEMPERATURE	2
2.1 SOLVING THE PROBLEM OF SIMULTANEOUSLY HEATING PARTS OF A BUILDING WHILE COOLING OTHERS	2
2.2 SUPPLY AIR TEMPERATURE CONTROL	5
CHAPTER 3: STATIC PRESSURE	6
3.1 ALL LOW PRESSURE/PART MEDIUM PRESSURE OPTIONS	7
3.2 STATIC PRESSURE CONTROL OPTIONS	8
3.3 SIZING DUCTS FOR MODULAR VAV SYSTEMS	9
CHAPTER 4: OVERHEAD HEATING	10
SYSTEM DESIGN CHECKLIST	12

WHAT IT NEEDS

Supply Air Temperature

- Constant temperature. May be reset to another constant temperature.
- Cooling between 50°F/10°C and 68°F/20°C
- Heating between 80°F/26.5°C and as low as possible - not to exceed 120°F/49°C

Static Pressure

- High enough for required air volume. No lower than 0.05"wg/12Pa.
- Below rated static pressure for design sound level. No higher 0.25"wg/62Pa suggested.

The Therma-Fuser diffuser is a simple stand alone device that provides VAV control when supplied with air in a suitable range of temperature and pressure. When designing the system, there are two primary objectives:

1. SUPPLY AIR TEMPERATURE

When supplied with cool air, the Therma-Fuser dampers modulate open on a rise in room temperature. When supplied with warm air, the dampers open on a room temperature drop. Cool air should be a constant temperature not less than 50°F/10°C (40°F/4.5°C for model LT-HC) and warm air at a constant temperature of not more than 120°F/49°C. (See chapter 4.1)

Changeover from cooling to heating occurs as the supply air rises from 76°F/24.5°C to 80°F/26.5°C and changes back from heating to cooling when the supply air drops from 72°F/22°C to 68°F/20°C. During changeover the Therma-Fuser diffuser is either closed or in partial control.

2. STATIC PRESSURE

Static pressure at the inlet of the Therma-Fuser diffuser must be high enough to obtain the required air volume, but no lower than (0.05"wg/12 Pa or more) for good temperature sensing. Above 0.25"wg / 62 Pa the sound level becomes noticeable (NC35) and around 0.40"wg/100 Pa the dampers begin to leak. When the static pressure is held constant, the sound level will decrease as the Therma-Fuser dampers close.

The following chapters have more about Supply Air Temperature, Static Pressure and other fundamentals of HVAC system design.

DESIGNING THERMA-FUSER VAV SYSTEMS

CHAPTER 1: SIZING AND LOCATION OF THERMA-FUSER DIFFUSER

Therma-Fuser diffusers are sized for the design or maximum air volume required using the published performance guide. Use a larger inlet size at a lower static pressure when lower sound or NC levels are required and when Therma-Fuser diffusers are at the end of a duct run where less static pressure is available. **Therma-Fuser diffusers may be oversized.** They will simply turn-down air flow to match the space load. Unlike fixed diffusers used with VAV boxes, Therma-Fuser diffusers won't dump when turned down.

Locating Therma-Fuser diffusers is no different than locating standard diffusers. Spacing is determined by the largest air volume and throw expected, usually the maximum cooling volume. Most guidelines suggest that diffusers be placed so that the 50-100 fpm/.25-.50 m/s velocity just reaches the wall, with the **maximum velocity at the wall being 150 fpm/.76 m/s** (our preference for outside walls).

Standard guidelines should also be followed when putting multiple diffusers in the same room. When possible the diffusers should be **no closer together than twice the throw at the 150 fpm/.76 m/s level.** Ideally they should be located somewhere between twice the 50 fpm/0.25 m/s and 100 fpm/.50 m/s levels.

Therma-Fuser diffusers can be located closer together than other diffusers without risk of opposing air jets forcing cool air into the occupied zone while in the cooling mode. Because of high entrainment and thorough mixing, the supply air reaches room temperature before it enters the occupied zone.

Maximum installation height for effective heating is 12ft / 3.37m.

Heights below 10ft / 3m are preferred. Cooling only Therma-Fuser diffusers can operate well at heights around 20ft / 6m.

Because Therma-Fuser diffusers control room temperature by sensing room air induced up the center of

the space, **care should be taken not to disturb room air induction and entrainment.** For example, location next to walls or dropped lights results in the reflection of primary air back at the Therma-Fuser diffuser. Avoid this with a three-way blow pattern or relocate either the Therma-Fuser diffuser or the light.

Use minimum flow stops on the Therma-Fuser diffuser located in the same room as the changeover thermostat for the system.

For individual temperature control, a return for each Therma-Fuser diffuser is preferred. This tends to avoid air below one Therma-Fuser diffuser drifting below an adjacent Therma-Fuser diffuser. As a minimum install at least one return in each room. Do not use through the door or over the wall returns.

Manual balancing dampers should be used at the takeoff for each diffuser. Manual balancing dampers may not be required with ducts designed to Acutherm specifications.

CHAPTER 2.1: SOLVING THE PROBLEM OF SIMULTANEOUSLY HEATING PARTS OF A BUILDING WHILE COOLING OTHERS

Problem:

During winter conditions parts of a building need heating while other parts require cooling. (Shown for Northern hemisphere.)

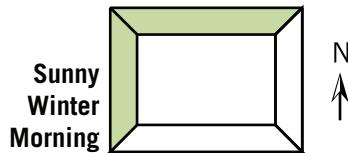

Heating required north and west exposures. Cooling required interior* and east and south exposures.

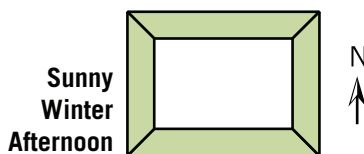

Heating required north and east exposures. Cooling required interior* and south and west exposures.

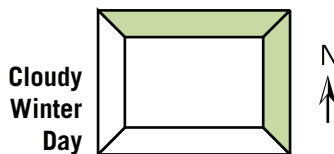

Heating required all exposures. Cooling required interior.*

Note that this is not a problem for summer conditions.

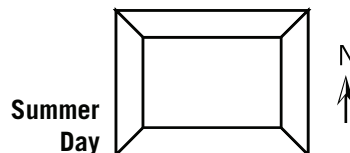

Cooling required all portions of the building.

*Some interiors may need heat due to losses at the ceiling or floor.

Solutions:

Solutions involve providing master zoning. Master zones are sources of heating and cooling. Subzones are Therma-Fuser VAV diffusers which provide individual temperature control.

Master zone options described in this chapter are:

- 1). Multiple AHU
- 2). Separate perimeter heat
- 3). Perimeter duct heat stations
- 4). One heat/cool zone per floor
- 5). Corner offices



Therma-Fuser™ Systems

DESIGNING THERMA-FUSER VAV SYSTEMS

CHAPTER 2.1: continued

2.1.1: Multiple AHU

This is the simplest and perhaps the easiest to control of all master zone options. A disadvantage might be the need for more risers in multi-story buildings. AHUs may be chilled water, DX, heat pumps or fan coil units.

A square building requires five AHUs, one for each exposure and one for the interior.

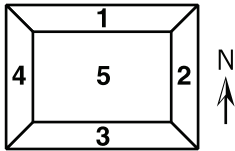

These can be five AHU per floor or with vertical master zones, five per building.

Upper floor may need heating

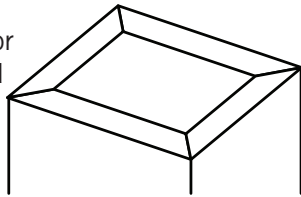

Many buildings are long and narrow enough (sometimes no windows on the end) for three AHUs.

Single Floor—NO



Single Floor—YES

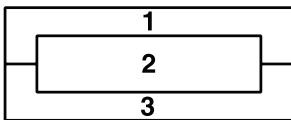

Multiple Floors with Three Vertical Master Zones

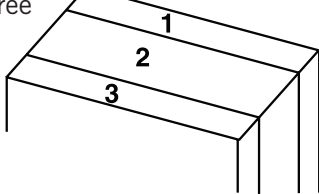

Each AHU is subzoned with Therma-Fuser diffusers to achieve individual temperature control. For control of the heating-cooling AHUs, see Chapter 2.2.

2.1.2: Separate Perimeter Heat

Because a separate perimeter heat system is sized to handle the heat loss through the skin of the building, the need for separate heating and cooling in the various parts of the building is eliminated. The central system can be one cooling only master zone. Therma-Fuser subzones provide individual temperature control.

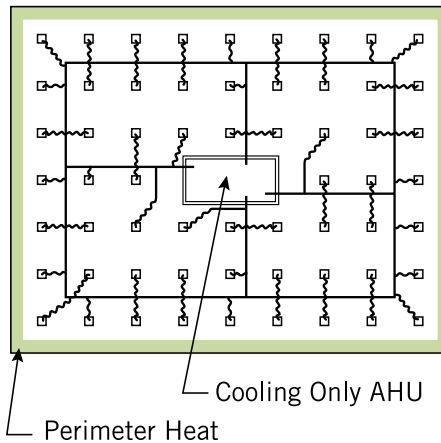

Small perimeter heating zones (one per office) combined with Therma-Fuser subzones for the central system are the best for handling traveling shadows.

Options for separate perimeter heat are:

- 1) Baseboard—electric, hot water or steam.
- 2) Radiant panels—electric or hot water.
- 3) Ducted air from a separate AHU—electric, hot water, gas or steam.

This heat is sized to only handle the heat loss through the skin of the building plus the reheat load of any minimum air flow. The thermostat must be located to sense the skin loss. Preferred locations are in the baseboard, or within two feet from the outside wall, on a wall perpendicular to the outside wall. Do not use the common location by the door on the

wall opposite the outside wall.

Use Type-C Therma-Fuser diffusers where there is no central heat. Type-HC Therma-Fuser diffusers are recommended with central heat for warm-up to avoid overheating some spaces.

To avoid conflict between the perimeter heat and the Therma-Fuser diffuser use a deadband between the setpoints. Achieve the deadband with a high limit stop of say 70°F/21°C on the perimeter heat and a cooling setpoint of say 74°F/23°C on the Therma-Fuser diffuser.

Where electric heat is necessary, save energy by using less expensive central heat when zoning is not important (unoccupied times) when heating loads are the largest (nights). The electric heat can provide small master zones during occupied hours. Use central heat with gas, hot water or steam for unoccupied times and warm-up.

2.1.3: Perimeter Duct Heat Stations

Size perimeter duct heat stations as large as possible—perhaps only one per exposure. The simplest is a heating coil, either electric or hot water. The heating coil may be combined with a zone damper for static pressure control when downstream of higher pressure systems. Or a VAV reheat box can be used. Another alternative is an intermittent fan powered box. Therma-Fuser diffusers provide individual temperature control. (The interiors may also require zone dampers for static pressure control).

When electric heat is used, consider using less expensive central heat during unoccupied times and warm-up.

Continue on next page

DESIGNING THERMA-FUSER VAV SYSTEMS

CHAPTER 2.1.3: continued

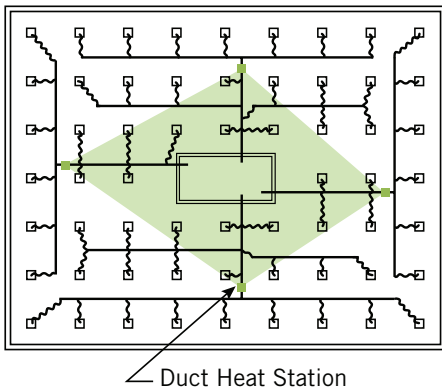

For other Acutherm references on how to subzone Heating Coils, VAV Reheat Box, and/or Intermittent Fan Powered Box, please visit www.acutherm.com and go to:

- Documents
- Resources
- System Design
- Specific Systems

2.1.4: One heat/cool AHU per floor

One heating cooling AHU can be used for one floor or one building. These are usually DX; either a heat pump or with some form of central heat such as a gas furnace. This approach is more common in smaller buildings which have little or no interior area.

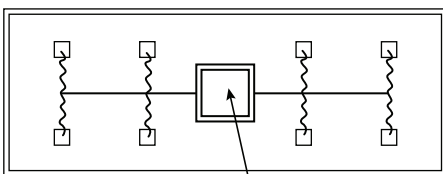

Heating/Cooling AHU

The economics of a simple system may be more important than resolving the problem caused by winter conditions. Using Type-HC Therma-Fuser diffusers will not resolve the problem but they may ease it. If cooling is being supplied, the Type-HC Therma-Fuser diffusers will close in areas requiring heating. When heating is supplied, the Type-HC Therma-Fuser diffusers will close in areas requiring cooling.

Of course, when open, the Therma-Fuser diffusers will still provide individual temperature control—varying air flow to suit the loads beneath them.

(See www.acutherm.com for Designing Specific Systems such as subzoning DX units.)

2.1.5: Corner offices

Corner offices may have a need between cooling on one side and heating on another. This is resolved with separate perimeter heat but could be a problem for multiple AHU's and perimeter duct heat stations. Solutions for situations other than separate perimeter heat are:

- a. Provide a **separate master zone** for the corner office. This is the most expensive solution.
- b. The most preferred solution is to **supply from two master zones** which at times could have one in heating and one in cooling. Subzone with Type-HC Therma-Fuser diffusers. Depending on the load when one master zone is heating and the other is cooling, one Type-HC will be closed and the other modulating.

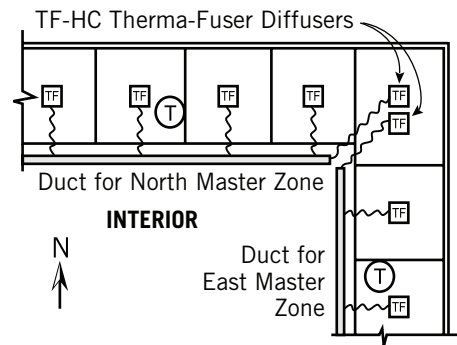

- c. **Supply from one master zone selected because it probably will dominate.** There is also the risk that it may not. This approach probably would supply the SE and SW corner offices from the south master zone. The NE corner is supplied from the east master zone. The NW corner from the west master zone. Using Type-HC Therma-Fuser diffusers will reduce the risk.

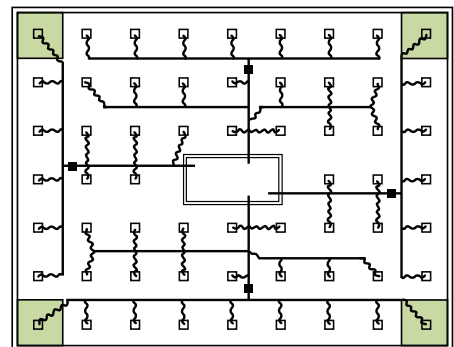

Chapter 2.2: SUPPLY AIR TEMPERATURE CONTROL

Location of the BMS sensor or the thermostat to control the DX compressor, AHU water valve or heat is important to having enough cooling or heating to satisfy the separate zones in a VAV system. If the system control cuts off too early, the area of the building with the greatest needs will not be satisfactorily conditioned. Most VAV devices including Therma-Fuser diffusers, can not make up for lack of air or lack of temperature.

Objectives of supply air temperature control are:

1. **Provide a constant supply air temperature.** Variable air volume systems require a constant supply air temperature.

Variable supply air temperature is for constant volume systems. Using variable supply air temperature control with a VAV system may result in constant volume supply. Where resetting is required, reset to another constant supply air temperature. DX equipment and on/off heating, such as electric or gas, can only approximate constant supply air temperature by cycling within limits.

2. **Limit supply air temperature.** Cool air supplied to Therma-Fuser diffusers should not be less than 50°F/10°C

CHAPTER 2.2: continued

(40°F/4.5°C for model LT-HC) and hot air not more than 120°F/49°C. Low limits prevent DX coil freezing when bypass static pressure control is used. Limiting hot air temperature also reduces room stratification.

- 3. Provide changeover from heating to cooling.** Therma-Fuser diffusers changeover from cooling to heating as the supply air rises from 76°F/24.5°C to 80°F/26.5°C. During changeover the Therma-Fuser diffuser is in partial control.

2.2.1: Options for locating the Temperature Sensor or Thermostat

- 1. Supply air**—best for constant supply air temperature. Always able to satisfy design air temperature for each space. Not able to control heating cooling changeover.
- 2. Room air**—controls the room with the sensor. Should be in the room with the greatest heating and cooling needs—the Therma-Fuser diffusers then turn down in other rooms. Greatest heating and cooling needs are seldom in the same room and the room may be unoccupied at times. Does not limit supply air temperature. Use room air sensors for heating/cooling changeover selection; especially good when sensing in more than one room.
- 3. Return air**—not recommended for VAV systems. Senses average system need which may not satisfy area of maximum need. Often used for constant volume system control.

Objectives and Options

	SUPPLY AIR	ROOM AIR	RETURN AIR
1). Constant supply air temp.	X		
2). Limit supply air temp.	X		
3). Changeover		X	

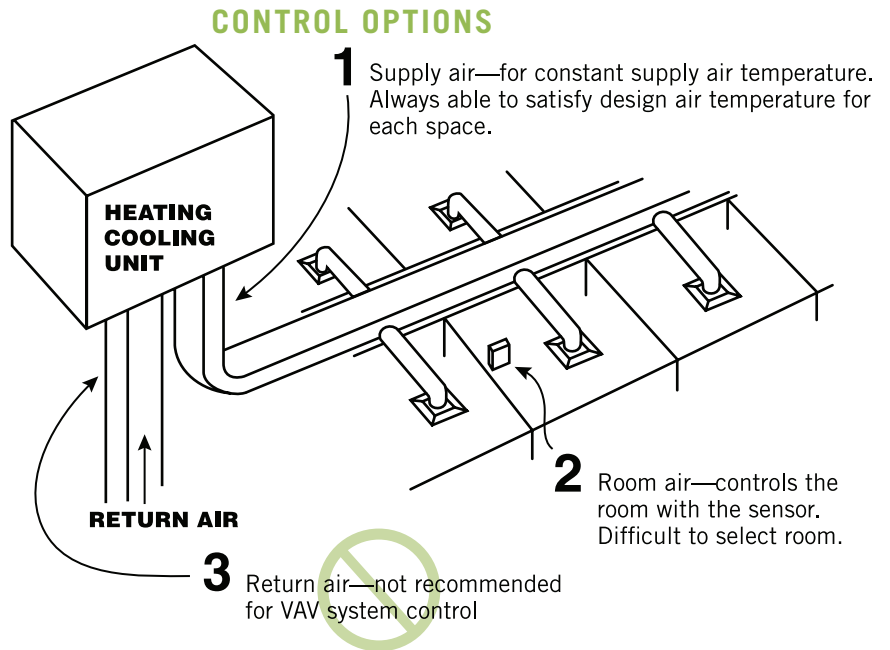

Systems with part fixed diffusers

Where part of the system has fixed diffusers and part has Therma-Fuser diffusers, control supply air from a room sensor or thermostat located with one of the fixed diffusers. This should be an area of greatest heating/cooling need if that can be determined. Or it may be simply in the most important room such as the boss's office.

2.2.2: Preferred where all diffusers are Therma-Fuser diffusers

The preferred control, where all diffusers are Therma-Fuser diffusers, is with a discharge air sensor or thermostat. Whenever possible, cooling is modulated to maintain a constant supply air temperature below 68°F/20°C and above 50°F/10°C. For DX equipment this is a low limit. A limit at a higher temperature is used for a second stage cooling and higher again for additional stages. Where a bypass for static pressure control is used, locate the discharge air sensor upstream of the bypass.

Heating, like cooling, whenever possible is modulated to maintain a constant supply air temperature above 80°F/26.5°C and below 120°F/49°C. To reduce stratification the hot supply air temperature should be no higher than necessary on a design day. (See chapter 4.1)

Continued on next page



Therma-Fuser™ Systems

DESIGNING THERMA-FUSER VAV SYSTEMS

CHAPTER 2.2: continued

For on/off heat this control becomes a high limit. A limit at lower temperatures is used for second stage heat and lower again for additional stages.

At least one room sensor or thermostat is used to determine changeover between heating and cooling. Where multiple room sensors or thermostats are used, one may call for heating while another calls for cooling. Resolve this with either a cooling dominant or majority rules approach.

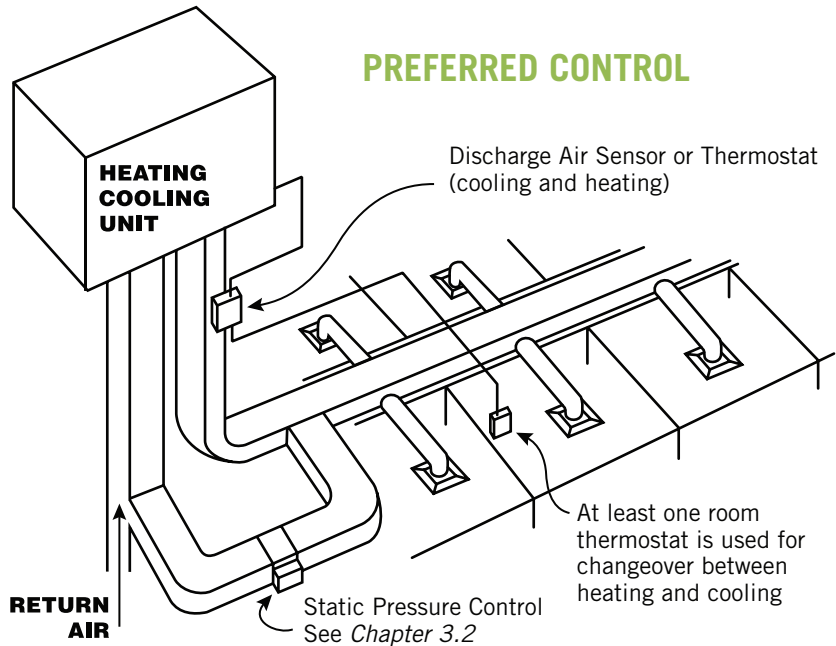

CHAPTER 3.1: ALL LOW PRESSURE / PART MEDIUM OPTIONS

All diffusers including Therma-Fuser VAV diffusers should be supplied with low pressure air (0.25"wg/62Pa or less) to avoid noise (NC 35 or greater). Manual balancing dampers should be used at the takeoff for each diffuser. Manual balancing dampers

may not be required with ducts designed to Acutherm specifications. Systems with low pressure ductwork from the fan on should be used whenever possible because of the high energy savings of a much smaller fan motor.

In many cases such as multiple floors served by a single air handler, complete low pressure systems become impractical because of the lengthy duct runs involved. (A practical limit for low pressure may be equivalent duct lengths between 200ft/61m and 250ft/76m.) In these situations systems are designed as part medium pressure between the fan and static pressure control stations and part low pressure from the static pressure control stations to the end of the run.

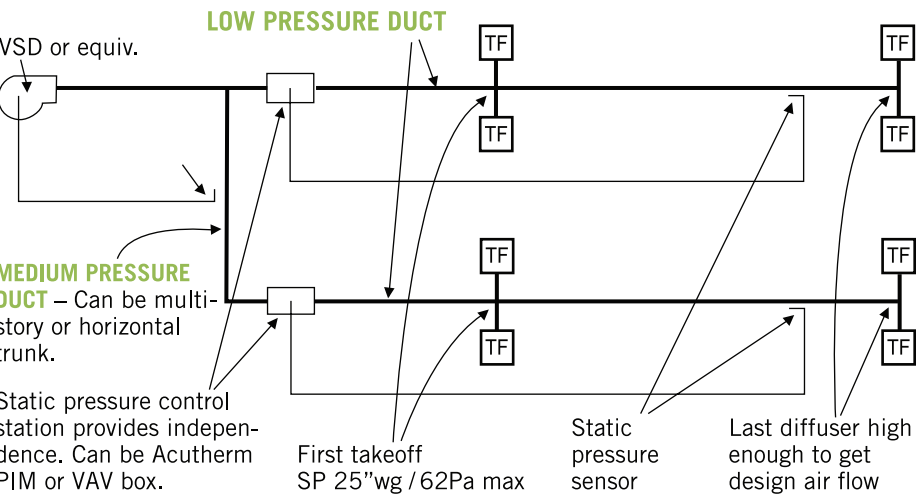
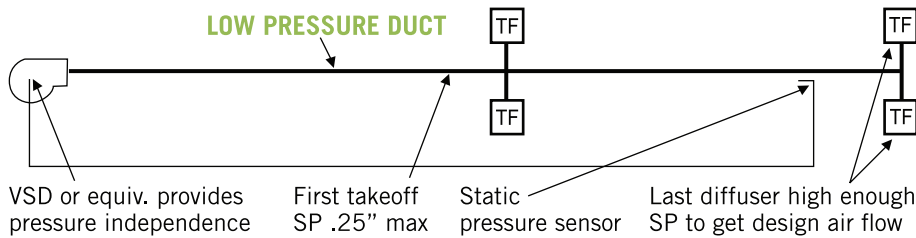

VSD = Variable Speed Drive

CHAPTER 3.2: STATIC PRESSURE CONTROL OPTIONS

Objectives of static pressure control are:

1. Provide high enough static pressure (0.05"wg/12Pa minimum) to obtain the required air volume at each Therma-Fuser diffuser.
2. Limit the static pressure at both full flow and turndown to avoid diffuser noise (0.25"wg/62Pa for NC 35) and leakage (0.40"wg/100Pa).

DESIGNING THERMA-FUSER VAV SYSTEMS

CHAPTER 3.2: continued

When the static pressure is held constant the sound level will decrease as the Therma-Fuser dampers close.

3. Pressure independence: consistent operation as the system air flow changes.

Manual dampers will not satisfy these objectives because the pressure drop across them varies as the air flow changes. $\Delta P = k_v (V/4005)^2$

These objectives can be achieved with the usual methods of automatic static pressure control; bypass dampers, zone dampers, and fan speed control. In addition, R-Rings, unique to VAV diffusers, provide bypass at the diffuser when the system has a ceiling plenum return.

Location of the static pressure probe for all options except the R-Rings should be at least $2/3$ or $3/4$ down the duct from the first takeoff. Do not locate it right after the damper or fan. The down stream location provides a lower static pressure control point which results in a quieter turndown operation.

Acutherm Pressure Independence Modules (PIM™) are designed for use as bypass dampers or zone dampers.

For systems with part fixed diffusers, system turndown may be 30% or less. If so, static pressure control is not necessary provided the static pressure remains below 0.25"wg/62Pa at the diffusers.

Fan Speed Control

- Do not use with constant volume DX equipment

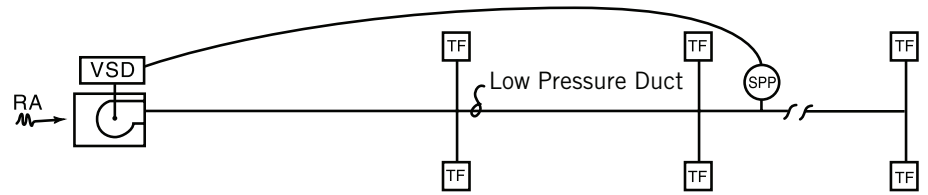

Zone Damper

- May also need static pressure control at fan
- Sound attenuation after the damper may be required for higher pressure drops.

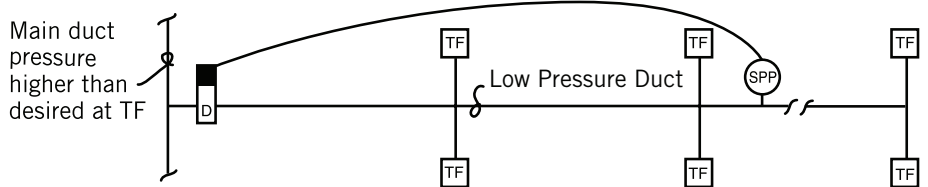

Bypass Damper — Ducted Return

- Size damper for total turndown of all Therma-Fuser diffusers.

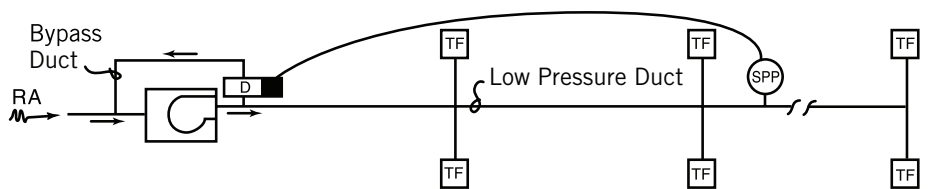

By pass Damper — Ceiling Plenum Return

- Size damper for total turndown of all Therma-Fuser diffusers.

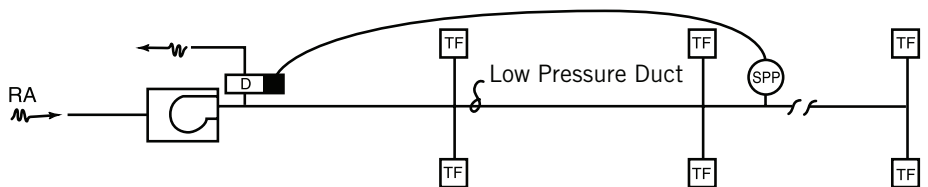

R-Ring Ceiling Plenum Bypass

- Do not use with ducted returns.
- Do not use with 3-, 2- or 1-way blow patterns. 4-way blow only.

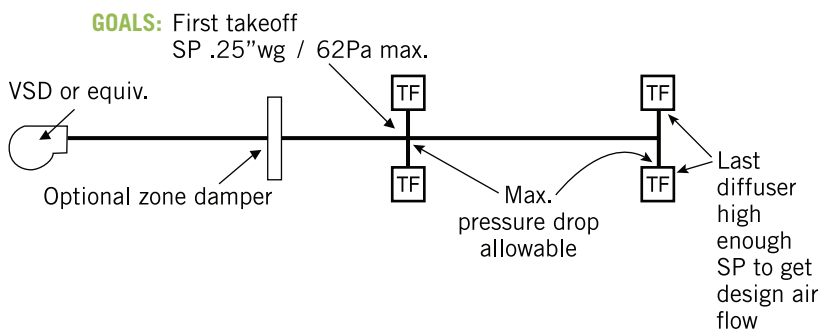
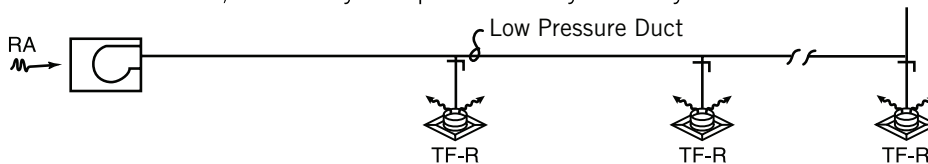

- D: Damper with controller and actuator
- TF: Therma-Fuser diffuser
- TF-R: Therma-Fuser diffuser with R-Ring
- SPP: Static pressure probe, locate approx. $2/3$ or $3/4$ down duct from first diffuser
- VSD: Variable speed drive



Therma-Fuser™ Systems

DESIGNING THERMA-FUSER VAV SYSTEMS

CHAPTER 3.3: SIZING DUCTS FOR MODULAR VAV SYSTEMS

Objectives of duct sizing are:

1. Limit maximum static pressure at the inlets of all Therma-Fuser diffusers to 0.25"wg/62Pa or below at both design and turndown conditions.
2. Maintain minimum static pressure at the diffusers especially those further away from the fan, at least 0.05"wg/12Pa or enough to provide design air flow.

To accomplish these objectives first, determine the maximum pressure drop allowable between the first takeoff and last diffuser. Once maximum pressure drop is determined choose one of the duct sizing methods listed and assign duct sizes accordingly.

3.3.1: Determine allowable pressure drop:

- #1. Locate Therma-Fuser diffusers and approximate duct runs on the building plan. Determine the air volume required for each diffuser.
- #2. From the performance ratings, determine the static pressure for design air volume at the last diffuser furthest from fan. Sometimes selecting a larger inlet size will lower the static pressure required.
- #3. Determine the static pressure required at the takeoff to the first diffuser after the fan or static pressure station. This is usually 0.25"wg/62Pa—

sometimes less if a lower NC is required at the first diffuser.

- #4. Subtract #2 from #3 for the pressure drop allowable.
- #5. Determine the equivalent length of duct, in feet or meters, from the takeoff of the first diffuser to the last diffuser. Equivalent duct length is total length of duct plus equivalent length of fittings.
- #6. Divide #4 x 100 by #5 for the pressure drop per 100 feet, or divide #4 by #5 for the pressure drop per meter.
- #7. Select duct size method. A description follows for:
 - a. Equal friction method
 - b. Friction loss reduction.

near the fan which are too large for the available space. This method uses higher pressure drops near the fan and reduced pressure drops downstream. The goal is to get a total pressure drop for the entire duct equal to #4.

- **Friction losses selected should be between .10"wg/100 feet or .82 Pa/m and .04"wg/100 feet or .33 Pa/m**
- **Velocities selected should be between 1300 fpm / 6.6 m/s and 700 fpm / 3.5 m/s**

1. Divide the first 100-150 Ft / 30-46m of duct into sections 20-30 ft / 6-9m long at appropriate transition points.
2. Next, friction loss figures are assigned to each section so that when pressure losses are analyzed total pressure drop is equal to #4. Assign friction loss to the section closest to the fan first. The remaining subsequent friction loss factors should be .01"wg/2.5 Pa lower than the previous one.
3. A good starting point for the first friction loss factor is 1.5 x #6 with a maximum value of .10"wg/25 Pa. A good minimum value for the last section is .04"wg/10 Pa.

3.3.2: Equal friction method

The simplest method of duct sizing is equal friction. Using the equal friction method, the same pressure drop per 100 feet/meter is used from the beginning of the duct to the end.

1. Select duct sizes by matching #6 (above) and the required air volume on a duct calculator.
2. Select remaining diffuser sizes for design air volume at the available static pressure.

3.3.3: Modified equal friction (friction loss reduction) method

The friction loss reduction method can be used in cases where the equal friction method yields duct sizes

3.3.4: Calculating pressure drop fittings

Several possibilities exist for calculating pressure drop in fittings.

A first method suggested by both ASHRAE and SMACNA uses loss coefficients for particular fittings to calculate the total pressure drop through the fittings. Explanation of this method is listed in both the ASHRAE Fundamentals chapter 32 and SMACNA HVAC Systems Duct Design chapter 5.

Another method uses published tables to determine equivalent length of a straight duct with the same pressure drop as the fittings. The

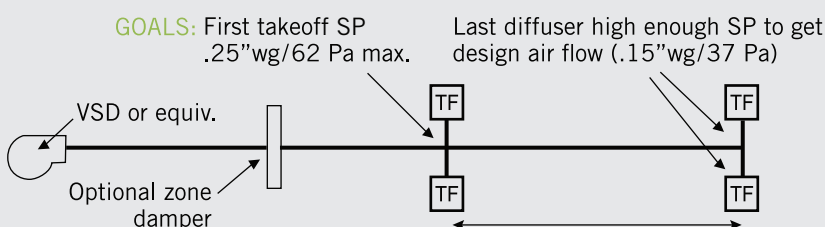

Pressure drop = 0.25"wg/62 Pa - .15"wg/37 Pa = .10"wg/25 Pa
If equivalent length = 100 feet/30 m, design for .10"wg drop per 100 feet/.82 Pa per m.
If equivalent length = 150 feet/36 m, design for .06"wg drop per 100 feet/.49 Pa per m.

DESIGNING THERMA-FUSER VAV SYSTEMS

CHAPTER 3.3.4: continued

equivalent lengths can then be added to the total length of the duct system.

A third method uses the SMACNA HVAC Duct Fitting Loss Calculator.

This calculator will provide fitting loss for various round and rectangular fittings as listed on the calculator itself.

The pressure drop can then be added to the total pressure drop of the duct sections.

CHAPTER 3.4: USING EXISTING DUCTS

The objective in using existing ducts are the same as those for designing new ductwork:

1. Limit maximum static pressure at the inlets of all Therma-Fuser diffusers to 0.25"wg/62Pa or below at both design and turndown conditions.
2. Maintain minimum static pressure at the diffusers (especially those furthest away from the fan) at least 0.05"wg/12 Pa, or enough to provide design air flow.

The characteristics of the existing duct system might be determined by theoretical calculation if both duct sizes and air volumes of the system are known.

Duct sizes are best obtained from "as built" drawings. Sometimes the original drawings are close enough to "as built." Otherwise a site survey might be required.

Existing air volumes may be used if the building envelope, lighting and office equipment have not changed over the years. Otherwise you may

want to assume 1 cfm/sq. ft. or 5 L/s/m² for the interior and 1.5 cfm/sq. ft. or 7.6 L/s/m² for perimeter space.

Theoretical calculation may not be necessary for short duct runs, i.e. less than 50 equivalent feet or 50 actual feet / 15m of straight duct (no elbows, tees, etc...). Static pressure control at the fan or AHU will be sufficient. (See Chapter 3.1). For longer duct runs use the Existing Duct Worksheet and apply the procedure below.

3.4.1: Duct system analysis:

1. Start at the end of the duct farthest from the fan or static pressure station. List the air volume required from the last diffuser on line 1, column 2.
2. Use Therma-Fuser diffuser ratings to determine static pressure required for this air volume and list on line 1, column 5 and 6. **Note:** A larger inlet size often results in a lower static pressure for the same air volume.
3. List the duct sizes for each portion of the duct between each take off in column 1 "Size".

4. List air volume (cfm or L/s) through each portion of the duct in column 2—"Air volume."
5. List the equivalent length of each portion of the duct corresponding to 1 and 2 in column 4 "Equivalent Length." Note: Equivalent length is actual length plus a factor for fittings such as elbows. (Elbows usually are around 50 ft/15 m equivalent length for low velocity ducts.)
6. Enter the information in 1 and 2 in a duct calculator to obtain "wg/100ft or Pa/m and list in column 3 "wg/100ft or Pa/m."
7. Obtain DP. Multiply column 3 by column 4 and divide by 100 or for metric multiply column 3 by column 4. List DP in column 5.
8. Add DP from this line to all preceding DPs in column 5 for the cumulative DP and list in column 6.
9. Stop when column 6 reaches 0.25"wg/62 Pa. This is the highest allowable. Install a zone damper (PIM) here. Install additional zone dampers as shown on page 10.

1	2	3	4	5	6
SIZE	AIR VOLUME	wg/100 ft. or Pa/m	Equiv. Length	ΔP	Cumulative ΔP
Air vol. & S.P. @ inlet of last diffuser		N/A	N/A		

DESIGNING THERMA-FUSER VAV SYSTEMS

3.4.2: Additional zone dampers

Use zone dampers (PIMs) for branches or takeoffs upstream of the zone dampers from #9. Fewer zone dampers can be used if several Therma-Fuser diffusers are grouped on a new branch known as a parallel duct. See chapter 3.3 for sizing of the parallel duct.

3.4.3: Alternatives to theoretical calculations are:

1. Field examination may indicate what the duct static pressure will be at full air volume. Open all manual balancing dampers to achieve maximum system air flow and measure static pressure at the first and last takeoff. The difference is the pressure drop of the duct system at maximum air flow. If the drop is greater than $0.25''\text{wg}/62\text{ Pa}$, zone dampers will be necessary.
2. The owner may elect to undergo the upgrade with the knowledge that more ductwork may have to be added later if the existing ducts prove to be too small. In this option the owner tolerates some experimentation because it is intended to save money.

Zone Damper Per Takeoff

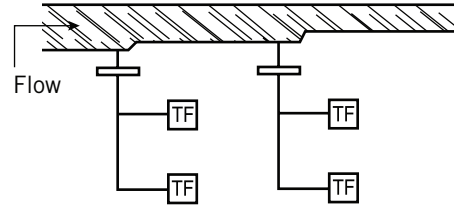

Zone Damper Per Takeoff

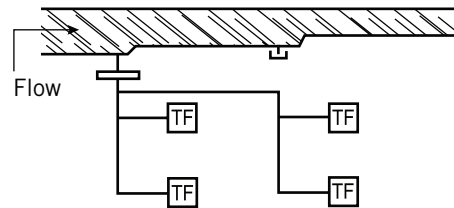

CHAPTER 4: OVERHEAD HEATING DIAGRAM

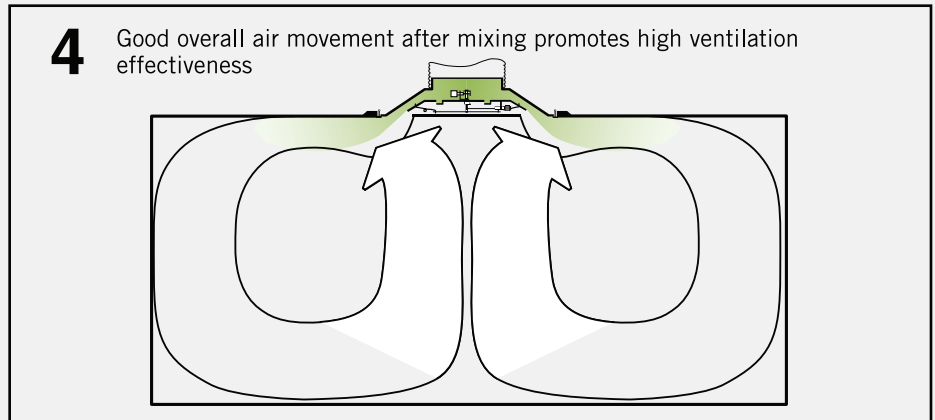
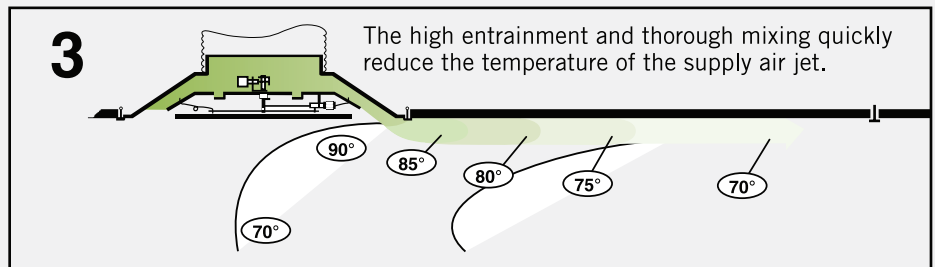
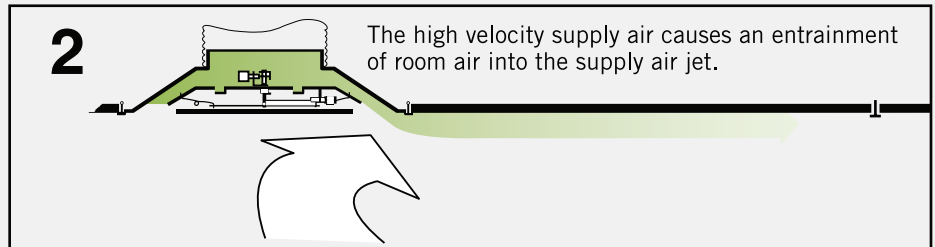
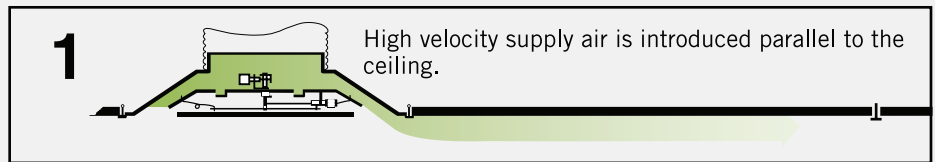

DESIGNING THERMA-FUSER VAV SYSTEMS

CHAPTER 4: OVERHEAD HEATING

The key to successful heating from the ceiling is relatively high discharge velocity, which provides high entrainment and good room air motion. Rapid mixing produced by entrainment quickly lowers the temperature of the supply air, eliminating buoyant warm air at the ceiling. Good room air motion further reduces stratification by gently circulating the mixed throughout the room.

The Therma-Fuser diffuser's variable opening results in an almost constant high velocity at both full flow and turn down. By varying supply air volume directly at the edge of the diffuser, Therma-Fuser diffusers maintain a discharge velocity of approximately 1500 fpm/7.6 m/s even at low flows.

4.1: Follow standard industry guidelines for overhead air heating.

Why It Is Not Necessary To Blow Warm Air Down Windows

The idea that down blow heating is necessary came from the time when buildings used single pane glass and were not well insulated. Even in cold climates, most of today's buildings with double pane glass and those meeting ASHRAE 90.1-1989 or newer have perimeter heat losses less than 250 BTU/hr/lineal foot/240 W/m. Also, the inside surface temperatures of well insulated double pane glass in cold areas such as Minneapolis (-16°F / -27°C winter design) are well above 50°F / 10°C.

These buildings do not approach the guidelines where down blow heating is recommended (350 BTU/ hr / lineal foot / 336 W/m). In addition, low heat losses mean that spaces in cold climates can be heated with lower temperature air resulting in less stratification. Typical heating supply air temperatures for various regions are shown below.

- Heat loss less than 350 BTU / hr / lineal foot / 336 W/m
- Indoor glass surface temperature 50°F/10°C or greater
- Supply air temperature less than 95°F/35°C.

Buildings meeting ASHRAE 90.1-1989 are within these guidelines.

Sufficient for buildings with heat loss less than 350 BTU / hr / lineal foot / 336 W/m.

4.2: Use a four-way blow pattern

Extensive testing in the Acutherm labs shows that for heating, a properly located square Therma-Fuser diffuser with a four-way blow pattern produces the highest percentage of points in the occupied zone that fell within the temperature and velocity ranges set by the ASHRAE comfort standard 55. Also tested were three-way blow patterns and a linear Therma-Fuser diffuser both located at the window. These produced a lower percentage of points in the ranges set by the comfort standard.

4.3: Maintain supply air temperature between 80°F/26.5°C and 95°F/35.0°C

The supply air temperature should be chosen as low as possible. This reduces stratification in two ways. First, a lower temperature means the air is less buoyant and mixes better with room air. Second, more air is delivered to the room which aids in mixing of supply and room air. The approximate supply air temperature required can be estimated using the map shown below.

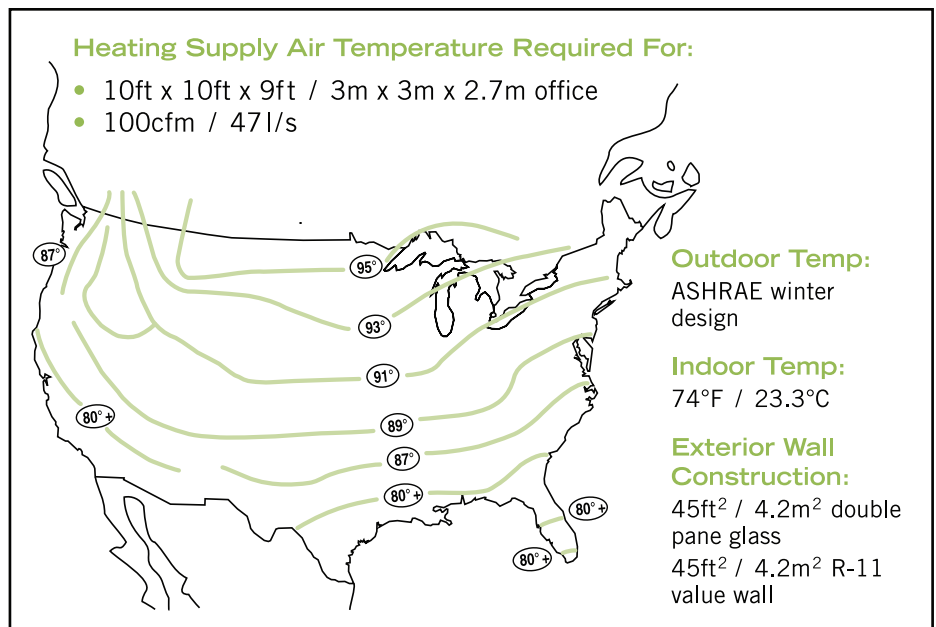

SYSTEM DESIGN CHECKLIST

Note: This is a general checklist. For detailed recommendations about specific systems visit the Documents section at www.acutherm.com.

Job Name _____

1. THERMA-FUSER DIFFUSER SIZE AND LOCATION

- Air volume sufficient for room needs. Correct inlet sizing for available static pressure.
- All Therma-Fuser diffusers within two feet of wall equipped with three-way blow away from wall.
- Multiple Therma-Fuser diffusers in same room—space no less than two times the 150 fpm/.76 m/s throw, use three-way blow if closer.

2. SUPPLY AIR TEMPERATURE

— Cooling Min. 50°F / 10°C (40°F / 4.5°C for Model LT-HC)
Heating Max. 120°F / 49°C
Changeover: To Heating 80°F / 26.5°C
To Cooling 68°F / 20°C

• Source of cooling:

- Chilled water AHU
- DX

• Source of heating:

- AHU heat
- Duct heat
- Heat Pump
- Separate perimeter heat —
- Gas
- Hot Water
- Electric
- Steam
- Baseboard
- Radiant panels
- Separate duct

• Portions of building in one master zone:

- One exterior *Note: Separate master zones are preferred for the interior and each exposure*
- More than one exterior
- Interior
- Other _____

• Supply air fan:

- Fan runs continuously

• Location of thermostat (or BMS sensor) used to control the AHU water valves or DX compressor.

Note: Do not use a return air thermostat (sensor)

- System using some Therma-Fuser diffusers and some fixed opening diffusers
 - Room thermostat or sensor located in room of highest heating and cooling load. Fixed opening diffuser used in this room.
- Complete Therma-Fuser System
 - Preferred approach—Supply air control / room changeover
 - Supply air temperature controlled by discharge air thermostats (sensors)
 - Mode selected by changeover thermostat (sensor) in the room. Therma-Fuser diffuser with minimum flow stops in this room.
 - Acutherm SMC

3. STATIC PRESSURE

— Inlet Min. 0.05"wg / 12 Pa Or High Enough For Required Air Volume
Inlet Max. 0.25"wg / 62Pa For NC 35 Or Less

• Control

- Less than 30% turndown of system air—Static pressure control usually not necessary.
- Over 30% turndown of system air.

Static Pressure Control With:

- Fan Control
 - Variable speed drive
 - Other _____
- Zone Control damper
- Bypass
 - Damper
 - R-Rings—Use only with ceiling plenum return
- Both fan and zone control

Static pressure sensor located 2/3 or 3/4 of the equivalent duct length between control and end of duct.

• Duct Design

Supply:

- Static pressure no higher than 0.25"wg / 62Pa at the first takeoff downstream from the static pressure control.
- Sufficient static pressure at the last Therma-Fuser diffuser to obtain the required airflow. Size last Therma-Fuser diffusers larger to achieve required flow at lower static pressures.

Zone dampers are necessary where pressure losses in ducts are too high.

Manual balancing dampers should be used at the takeoff for each diffuser. Manual balancing dampers may not be required with ducts designed to Acutherm specifications.

Return:

- Ceiling plenum
 - Ducted
 - Other _____
- One return for each Therma-Fuser diffuser preferred. Minimum of one return per room.

